

Mixed Mode Simulation for IEEE 802.11-operated WLANs: Integration of Packet Mode and Fluid Model Based Simulation

Hwangnam Kim and Jennifer C. Hou
 Department of Computer Science
 University of Illinois at Urbana-Champaign
 Urbana, IL 61801
 E-mail: {hkim27,jhou}@cs.uiuc.edu

Abstract—In this paper, we address the issue of integrating packet level simulation with fluid model based simulation for IEEE 802.11-operated wireless LANs (WLANs), so as to combine the performance gains of the latter with the accuracy and packet level details afforded by the former. In mixed mode simulation, foreground flow is simulated at the packet level, while the other background flows are approximated into a collection of fluid chunks and simulated in the fluid mode. Note that these two types of flows influence each other at the point of interaction, e.g. the wireless channel in a WLAN. In order to realize mixed mode simulation, we develop the model of interaction at the wireless channel between the foreground flow and the other background flows, in view of their achievable throughput. We then implement mixed mode simulation in *ns-2* [2], and conduct a comprehensive simulation study to evaluate mixed mode simulation with respect to accuracy (in terms of error discrepancy) and efficiency (in terms of speed-up in conducting simulation).

Simulation results indicate that for IEEE 802.11-operated WLANs, it is feasible to blend fluid model based simulation into packet level simulation, and the performance improvement is quite significant while the accuracy and the packet level details desired are not compromised. Specifically, mixed mode simulation incurs only approximately 2 % of the error discrepancy, and reduces the execution time by two orders of magnitude. This, coupled with the fact that mixed mode simulation is able to retain packet level details for the connection of interest, makes it an excellent candidate for carrying out large-scale simulation for IEEE 802.11-operated WLANs.

Index Terms—Wireless LANs (WLANs), simulation, performance evaluation, mixed mode simulation, fluid model based simulation

I. INTRODUCTION

Modern data communication networks are extremely complex and do not lend well to theoretical analysis. It is common that network analysis is only rigorously made after leaving out several subtle details that cannot be easily captured in the analysis [5], [16], [18], [19]. Instead, packet level, event driven simulation studies are usually carried out to better study the performance of network components, protocols, and their interaction. The main obstacle in packet level network simulation is, however, the vast number of packets that have to be simulated in order to produce accurate results. Each packet will generate a number of events (e.g., arrival of a packet at the router, its departure, and buffer overflow if the arrived packet depletes the buffer, just to name a few) on the path from the source to the destination and each event has to be executed at some specified time point. As the CPU time required is roughly proportional to the number of events that

have to be executed, packet level simulation easily becomes computationally expensive, if not infeasible, for simulating large-scale networks. What seems to be reasonable is really to combine theoretical modeling with packet level simulation.

Recently, *fluid model based simulation* has been proposed as a solution to alleviate the computational overhead in large scale network simulation [8], [9], [11], [13], [14], [15], [19], [21]. In fluid model based simulation, a cluster of closely-spaced packets is modeled as a fluid chunk at a specific time point, and the behavior that a fluid chunk exhibits is characterized by an analytical model in the time domain. A fluid model based simulator then keeps track of fluid chunks and their rate or quantity changes at each network component. As a large number of packets are abstracted as a single fluid chunk, fluid model based simulation is expected to be (much) less computationally expensive overhead. However, whether or not fluid model based simulation is feasible for simulating various network protocols has to be carefully studied with respect to the error discrepancy — the difference between the results obtained via packet level simulation and those via fluid model based simulation. For example, it has been shown that fluid model based simulation is not well-suited for studying the interaction of TCP at end hosts and active queue management (AQM) at routers *under light and/or sporadic traffic* [12], as it is built upon the assumption of existence of a large number of active flows in the network [14], [17], [19].

Network calculus based simulation was proposed by Kim and Hou [12] with the same objective (of expediting simulation with the use of theoretical models), but in the hope of mitigating the problems of fluid model based simulation under light/sporadic traffic. They characterize how TCP congestion control interacts with AQM strategies with network calculus theory [1], [4], [6], derive upper and lower bounds on the attainable TCP throughput, incorporate the models in *ns-2*, and then instrument the simulator to regulate TCP flows in compliance with the model.

Although network calculus based simulation indeed gives encouraging results [12], it cannot provide packet level dynamics, such as the instantaneous queue length and the packet dropping probability. (Note that fluid model based simulation also suffers from this shortcoming.) In some sense, theoretical model based simulation trades some degree of accuracy and packet level dynamics for simulation performance. If packet level details are of concern to users, the best approach seems to simulate foreground traffic (whose packet dynamics are of

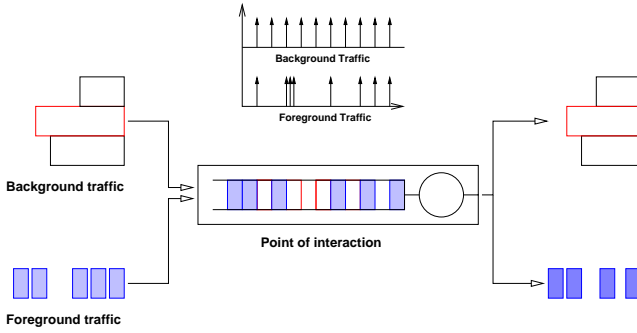

Fig. 1. Conceptual description for *mixed mode simulation*.

interest) in the packet mode, and model the background traffic (that comprise of possibly hundreds of flows) with a fluid model. The notion of *mixed mode simulation* (a.k.a. hybrid simulation) was proposed to combine the performance gains of fluid model based simulation with the accuracy afforded by packet level simulation. Fig. 1 gives a blueprint on mixed mode simulation. One foreground flow is simulated at the packet level, while the other background flows are approximated into a collection of fluid chunks and simulated in the fluid mode. Note that these two types of flows influence each other at the point of interaction, e.g. a routing buffer or a wireless channel.

One important issue of mixed mode simulation is to accurately characterize the interaction between foreground traffic and background flows, e.g., when, and how many, packets of a foreground flow should be dropped due to the existence of background fluid chunks (that may represent a large number of background packets) at a router and vice versa. In this paper, we investigate how to realize mixed mode simulation for IEEE 802.11-operated WLANs, by proposing the model of interaction at the wireless channel between the foreground flow and the other background flows, in view of their achievable throughput. This enables packet level simulation to co-exist and interact with fluid model based simulation within one simulation framework. In order to accomplish the goal, we need two analytical models: one that describes background flows in view of their data transmission activities, and the other that characterizes data transmission of the foreground flow, as well as its interaction with background flows. We then implement mixed mode simulation in *ns-2* [2], and conduct a comprehensive simulation study to evaluate mixed mode simulation with respect to accuracy (in terms of error discrepancy) and efficiency (in terms of speed-up in conducting simulation).

Simulation results indicate that mixed mode simulation is quite effective in studying transmission activities in WLANs equipped with IEEE 802.11. The execution time is reduced by, in most cases, more than two orders of magnitude as compared to that incurred in packet level simulation. The performance improvement becomes more salient as the number of wireless nodes within a WLAN increases, and/or as the rate of packet events generated in packet level simulation increases (e.g. the number of application per node increases). Furthermore, the relative errors incurred in mixed mode simulation with the time stepping technique fall within 2 %, as long as the value

of the time step is appropriately determined.

The rest of the paper is organized as follows. In Section II, we summarize the related work in the literature in two perspectives: fast theoretical model based simulation techniques, and the method of analyzing throughput on the IEEE 802.11 MAC protocol. In addition, as we will leverage the analytical models that we devised to characterize data transmission in IEEE 802.11 [11], we provide a summary in Section II. In Section III, we elaborate on how to describe the interaction between the foreground flow and multiple background flows in perspective of their attainable throughput. Following that, we validate the interaction model with simulation in Section V, and conduct a comprehensive simulation study in Section VI to evaluate mixed mode simulation against both fluid model based simulation and packet level simulation. Finally, we concludes the paper with Section VII.

II. PRELIMINARY

In this section, we give a succinct overview of existing work that pertains to expediting network simulation with the use of theoretical models, and to analyzing system throughput in IEEE 802.11 with the DCF function. Then, we summarize the fluid model [11] that mixed mode simulation will employ to model background flows.

A. Related Work

Existing work for fluid model based simulation: Several early research efforts have focused on fluid model based simulation in simple networks. Liu *et al.* [13] demonstrated the fundamental performance gain in fluid model based simulation over (rather than a realistic network with detailed network protocols) simple network components. Milidrag *et al.* [15] presented various sets of differential equations that describe the behaviors of network components in the continuous time domain. They showed that as long as the behavioral characteristics in the continuous time domain can be exactly specified, fluid simulation gives results with reasonable error bounds. Wu *et al.* [21] studied the error behavior that simulation results exhibit in a simple $M/D/1$ network configuration.

As mentioned in Section I, fluid models have been recently used to study the throughput behavior of TCP congestion control algorithms, together with AQM schemes in the steady state [17], [18], [19], and applied in fluid model based simulation to show their effectiveness in reducing the simulation time [14], [8]. Liu *et al.* [14] and Gu *et al.* [8] solve fluid models with the numerical Runge-Kutta method, and incorporate numerical results in the simulation of large scale TCP/IP networks. Kim and Hou [11] investigate the feasibility of fluid model based simulation for IEEE 802.11-Operated wireless LANs (WLANs), in which a throughput model is developed to describe data transmission activities in wireless LANs and then incorporated into fluid model based simulation in *ns-2*. Their results show two orders of magnitude improvement with acceptable error bounds.

Network calculus based simulation: Kim and Hou [12] examine the feasibility of incorporating network calculus

models in simulating TCP/IP networks. By exploiting network calculus properties, they characterize how TCP congestion control — additive increase and multiplicative decrease (AIMD) — interacts with AQM strategies in the analytic model, and regulate TCP flows in a simulation engine with the derived model. They show that as compared with time stepped fluid simulation (TSHS), significant improvement can be made in expediting the simulation, while keeping the error discrepancy reasonably small. As indicated in Section I, although network calculus based simulation gives accurate steady state system throughput, it cannot show, due to the nature of network calculus, the transient behavior of the network, e.g., the instantaneous queue length and the packet dropping probability at each bottleneck link.

Analytical models for IEEE 802.11 MAC DCF protocol: Several analytical models for IEEE 802.11 MAC DCF protocol have been proposed [3], [5], [7], [10], [20]. Bianchi [3] models the binary backoff counter behavior of a tagged station as a Markov chain model. (In particular, Bianchi’s work captured all the protocol details, and motivated a significant amount of subsequent analysis work.) The work determines the transmission probability (τ) and analyzes the saturation throughput based on a constant and independent collision probability (p). However, it does not give any specific algorithm to determine the value of p . Nor does it consider in its Markov model the probability that the backoff counter is not decremented when the transmission medium is busy due to other data activities. In other words, the probability that the binary counter stays at the current value is not derived. They validate their model via simulation only in the case of saturated throughput.

Calí *et al.* [5] derive a theoretical throughput bound by approximating IEEE 802.11 with a p -persistent version of the IEEE802.11 protocol. The major contribution of this work is that they show that with the current parameter settings of IEEE 802.11, it can hardly achieve the theoretical capacity bound. As such, they suggest to incorporate a parameter tuning method in IEEE 802.11 so as to achieve the analytical capacity bound. In the analytic model, they only deal with IEEE 802.11 DCF without the RTS/CTS mechanism, and assume that all the stations always have packets ready for transmission.

Foh and Zukerman [7] analyze, by leveraging the throughput analysis by Bianchi [3], the saturation throughput with a Markov chain with a single server. They assume that the number of active stations increases according to a Poisson process and decreases according to the state dependent service process. Wu *et al.* [20] exploit the analysis procedure in Bianchi’s work to modify IEEE 802.11 DCF for reliable transport protocol over IEEE 802.11 WLANs. Ho and Ken [10] analyze the throughput under the assumption that traffic sources are Poisson processes. The retransmission activities after collision are, however, perhaps over-simplified.

Kim and Hou [11] take a different approach to analyzing data transmission activities in IEEE 802.11. They focus on how long it takes to successfully transmit one frame, and characterize such a time interval with the attempt rate (the rate at which a station in the WLAN attempts to transmit a frame) — a function of the current backoff timers over all

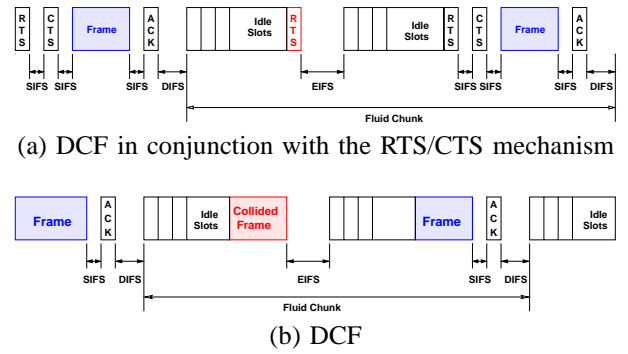

Fig. 2. The timing structure of a MAC fluid in IEEE 802.11.

the active nodes. The derived model takes into account of protocol details, such as the system parameters in the IEEE 802.11 standard and the overhead incurred in the physical and MAC layers, and does not make any assumption on the input traffic. It also accommodates both cases in which the RTS/CTS mechanism is and is not employed. The throughput model needed to realize mixed mode simulation is grounded on this model.

B. Fluid Model for IEEE 802.11-operated WLANs

In this section, we summarize the analytical model by Kim and Hou [11] that can be readily incorporated into fluid model based simulation for simulating IEEE 802.11-operated WLANs. The model will be integrated with another throughput model that describes data transmission activities of the foreground flow, so as to lay the mixed mode simulation framework.

The throughput model has two important analytical components: *fluid chunk* and *MAC fluid*. A *fluid chunk* is the time interval between two successful frame transmissions, and consists of a sequence of collision periods and one successful frame transmission time. *MAC fluid* is made up of one or more *fluid chunks*, separated by idle periods. Fig. 2 (a) and (b) respectively shows the timing structure for a *fluid chunk* within a *MAC fluid* in the IEEE 802.11 DCF standard.

The model approximates the time till the next, system-wide transmission attempt with an exponential distribution with the parameter λ . The parameter λ is determined as follows. If $\bar{b} = E(B_i)$ denotes the average backoff window size of all the nodes in the WLAN, then the average rate λ

$$\lambda = M \cdot \frac{1}{\bar{b}}. \quad (1)$$

With the rate λ as the input, the model describes all the data transmission activities and derives the mean values of the *MAC fluid* and the *fluid chunk*.

1) *Derivation of the Fluid Chunk:* Let Y be the length of a fluid chunk, i.e., the time it takes to successfully transmit a frame (Fig. 3). To facilitate the derivation of Y , the following set of random variables is defined in [11]:

- F : the r.v. representing the total length of collision periods in a fluid chunk;
- N : the r.v. representing the number of collisions in a frame service time or a fluid chunk;

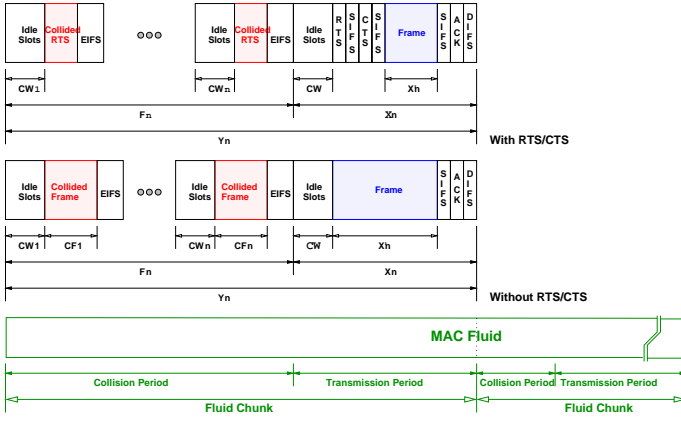

Fig. 3. Fluid chunk and its components.

TABLE I
IEEE 802.11 SYSTEM PARAMETERS.

Channel Rate	1 Mbps
Slot Time	20 μ sec
SIFS	10 μ sec
DIFS	50 μ sec
EIFS	SIFS + Phy preamble + header + t_{ACK} + DIFS
CW_{min}	32
CW_{max}	1024
Phy preamble	144 bits
Phy header	48 bits
MAC header	224 bits
ACK	112 bits
RTS	160 bits
CTS	112 bits

- N' : the r.v. representing the total number of idle periods in a frame service time or a fluid chunk; note that $N' = N + 1$;
- C_i : the r.v. representing the i th collision period;
- CW_i : the r.v. representing the number of idle slots before the i th collision or the successful transmission;
- CF : the r.v. representing the size of a collided frame;
- X : the r.v. representing the time it takes to successfully transmit a frame;
- X' : the r.v. representing the size of a frame (note that the distribution of CF is the same as that of X');
- $DIFS$, $SIFS$: the system parameters whose values are given in Table I.
- t_{ACK} : another system parameter defined as $t_{ACK} = ACK/1(Mbps)$.

The length of a fluid chunk, Y , can then be expressed in both the cases where the floor-acquisition RTS/CTS mechanism are employed and not employed: in the case that the RTS/CTS mechanism is employed, we have

$$Y = F + X, \quad (2)$$

$$F = \sum_{i=1}^N C_i, \quad (3)$$

$$C_i = CW_i + t_{RTS} + EIFS, \text{ and} \quad (4)$$

$$X = CW_{N'} + t_{RTS} + SIFS + t_{CTS} + SIFS + X' + SIFS + t_{ACK} + DIFS. \quad (5)$$

In the case that the RTS/CTS mechanism is not employed, all the above equations remain valid except Eqs. (4)–(5) which should be modified as follows:

$$C_i = CW_i + CF + EIFS, \text{ and} \quad (6)$$

$$X = CW_{N'} + X' + SIFS + t_{ACK} + DIFS. \quad (7)$$

In the above equations, t_{RTS} and t_{CTS} are obtained from system parameters specified in Table I as $t_{RTS} = RTS/1(Mbps)$, and $t_{CTS} = CTS/1(Mbps)$.

Based on the above equations, the model derives the mean value (and in some cases, moments) of each variable, in order to derive the expected length, \bar{y} , of a fluid chunk.

$$\bar{y} = \bar{f} + \bar{x}. \quad (8)$$

First, the expected value of the time it takes for one successful transmission is derived as

$$\bar{x} = \bar{c}w + t_{RTS} + SIFS + t_{CTS} + SIFS + \bar{x}' + SIFS + t_{ACK} + DIFS, \quad (9)$$

in the case that the RTS/CTS mechanism is employed, and

$$\bar{x} = \bar{c}w + \bar{x}' + SIFS + t_{ACK} + DIFS, \quad (10)$$

in the case that the RTS/CTS mechanism is not used.

Second, the expected number of collisions and the expected number of idle periods in one fluid chunk are, respectively,

$$\bar{n} = \frac{(1 - e^{-\lambda} - \lambda e^{-\lambda})}{\lambda e^{-\lambda}}, \quad (11)$$

$$\bar{n}' = \bar{n} + 1. \quad (12)$$

Third, the expected value of the total length of collision periods in one fluid chunk is derived to be

$$\bar{f} = \bar{n} \cdot \bar{c}, \quad (13)$$

where the expected collision period, \bar{c} , is

$$\bar{c} = \bar{c}w + t_{RTS} + EIFS \quad (14)$$

in the case that the RTS/CTS mechanism is used, and

$$\bar{c} = \bar{c}w + \bar{c}f + EIFS \quad (15)$$

in the case that the RTS/CTS mechanism is not used; $\bar{c}w$ and $\bar{c}f$ are, respectively, the expectation of CW and CF . Notice that the distribution of CF is the same as that of X' and is given.

Following that, the expected idle period before a collision or a successful transmission is derived to be

$$\bar{c}w = \frac{1 - (m\lambda + 1)e^{-\lambda m}}{\lambda(1 - e^{-\lambda m})}. \quad (16)$$

Finally, one can determine the expected length, \bar{y} , of a fluid chunk by plugging all the above results into Eq. (8).

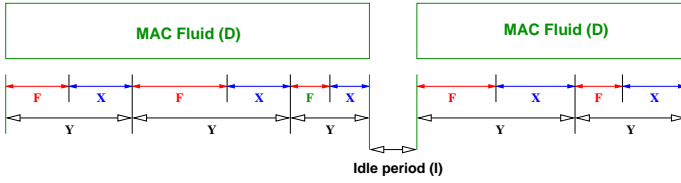

Fig. 4. MAC fluid structure.

2) *Derivation of the Length of a MAC Fluid:* As mentioned earlier and depicted in Fig. 4, a sequence of fluid chunks constitute a MAC fluid. Let D denote the random variable that represents the length of a MAC fluid. To derive the expected length, $\bar{d} = E(D)$, of a MAC fluid, the Laplace transform $E[e^{-sD}]$ is derived. First, the total number of idle slots in a fluid chunk, $CW_T \triangleq \sum_{i=1}^{N'} CW_i$, is derived:

$$\overline{cw_t} = \bar{n}' \cdot \overline{cw}. \quad (17)$$

Let Y_i denote the random variable of the i th frame service time, $CW_{T,1}$ the total number of idle slots in Y_1 , and K_1 the total number of transmission attempts in Y_1 . In the second step, $E[e^{-sD} | Y_1 = y, CW_{T,1} = \ell, K_1 = k]$ is derived. In a nutshell, $E[e^{-sD} | Y_1 = y, CW_{T,1} = \ell, K_1 = k]$ is derived based on the premise that, the condition that a total of $K_1 = k$ attempts for transmission are made in Y_1 implies that there will be *at least* $K_1 = k$ fluid chunks by the end of this MAC fluid. During the execution of a subsequent fluid chunk, new attempts may be made, thus ‘‘spawning off’’ more fluid chunks. Following that, $E[e^{-sD}]$ is derived by unconditioning each of the conditions and finally, the expectation of the length of a MAC fluid, \bar{d} is determined:

$$\bar{d} = (\bar{f} + \bar{x}) + \lambda \cdot \bar{d} \cdot \overline{cw_t}. \quad (18)$$

Rearranging the terms, we have

$$\bar{d} = \frac{\bar{f} + \bar{x}}{1 - \lambda \cdot \overline{cw_t} \cdot \bar{n}'}. \quad (19)$$

3) *Derivation of the Idle Period:* An idle period separates consecutive MAC fluids. Since each MAC fluid is triggered by one or more transmission attempts and the time till a transmission attempt is exponentially distributed with rate λ (Eq. (1)), an idle period between two consecutive MAC fluids is

$$\bar{i} = \frac{1}{\lambda}. \quad (20)$$

4) *Derivation of the System Throughput:* The fluid model determines the expected throughput with all the above derived results. Let \bar{n}_f denote the number of fluid chunks in a MAC fluid. Then, the expected throughput, T , can be expressed as

$$T = \frac{\bar{n}_f \times \bar{x}'}{\bar{d} + \bar{i}}, \quad (21)$$

where \bar{n}_f is approximated to be

$$\bar{n}_f = \frac{\bar{d}}{\bar{f} + \bar{x}}. \quad (22)$$

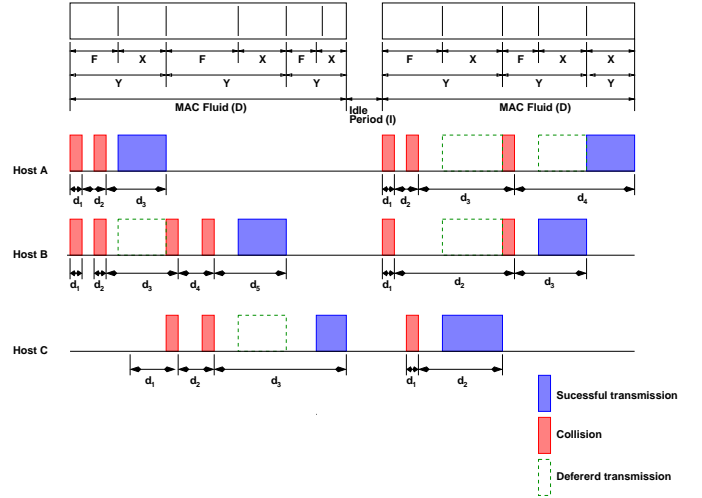

Fig. 5. Delay experienced by a tagged node.

III. THROUGHPUT MODEL THAT CHARACTERIZE INTERACTIONS BETWEEN FOREGROUND AND BACKGROUND TRAFFIC

Based on the fluid model [11] summarized in Section II-B, we derive the throughput model for one tagged flow so as to characterize the interaction between the tagged flow and the other (background) flows in view of the achievable throughput. In this model, the tagged flow is generated by one or multiple applications. (In the latter case, packets generated by multiple applications are multiplexed into one foreground flow.)

The throughput that a foreground flow can achieve depends on its interaction with the other background flows. Fig. 5 depicts how flows interact/affect one another. Let \bar{T}_{fg} denote the expected throughput of the foreground flow, \bar{d}_{fg} the expected delay that a frame in the tagged, foreground flow experiences, and \bar{x}' the average frame size. The throughput of a foreground flow can then be expressed as

$$\bar{T}_{fg} = \frac{\bar{x}'}{\bar{d}_{fg}}. \quad (23)$$

To derive \bar{T}_{fg} , we have to derive \bar{d}_{fg} . To facilitate the analysis of \bar{d}_{fg} , we define the following random variables

- D_{fg} : the r.v. representing the total delay experienced by a frame in the tagged flow;
- R : the r.v. representing the residual service time as seen by a frame of the foreground flow at its arrival;
- X_{fg} : the r.v. representing the current frame size in the tagged node;
- b_i : the r.v. representing the i th backoff time after the i th collision for $i \geq 0$;
- d_i : the r.v. representing the i th *deferred* backoff time after the i th collision for $i \geq 0$. According to IEEE 802.11, a node cannot decrease its backoff timer when the transmission medium is in use, i.e., $d_i = b_i +$ the time interval during which the medium is in use (Fig. 5).

With the above notations, we can express D_{fg} as

$$D_{fg} = R + \sum_{i=0}^{\infty} d_i + X_{fg}. \quad (24)$$

Note that the deferred time d_i instead of the backoff time b_i is used in Eq. (24). By taking the expectation of D_{fg} , R , and X_{fg} in Eq. (5), we have

$$E[D_{fg}] = E[R] + E\left[\sum_{i=0}^{\infty} d_i\right] + E[X_{fg}]. \quad (25)$$

Let $\bar{\tau} \triangleq \lim_{i \rightarrow \infty} E[R_i]$, and let \bar{d} and \bar{x}_{fg} denote the expected deferred time till the transmission of the tagged frame and the expected frame size, respectively. Then, we have

$$\bar{d}_{fg} = \bar{\tau} + \bar{d} + \bar{x}_{fg}. \quad (26)$$

The term \bar{d} in Eq. (26) can be derived as follows. Let \bar{b} denote the expected backoff window size, T_{slot} a physical slot time defined in Table I, and λ the rate at which the background flows attempts to transmit their frames. (As shown in Section II-B, λ is approximated to be $\lambda = N \cdot \frac{1}{b}$, where N is the number of background nodes.) Then the term \bar{d} in Eq. (26) can be written as

$$\begin{aligned} \bar{d} &= \ell_{size} \cdot \bar{b}, \quad \text{where} \\ \ell_{size} &= P_{idle,bg} \cdot T_{slot} + P_{collision,bg} \cdot (T_{slot} + \bar{c}_{bg}) \\ &\quad + P_{success,bg} \cdot (T_{slot} + \bar{x}_{bg}), \quad (27) \\ P_{idle,bg} &= e^{-\lambda}, \\ P_{success,bg} &= \lambda e^{-\lambda}, \\ P_{collision,bg} &= 1 - e^{-\lambda} - \lambda e^{-\lambda}, \end{aligned}$$

where \bar{c}_{bg} and \bar{x}_{bg} are, respectively, the expected length of collision period (due to collision of two or more background frames) and successful transmission period, both of which are caused by background flows.

The terms yet to be determined in Eq. (27) are \bar{c}_{bg} , \bar{x}_{bg} , and \bar{b} . To derive the former two terms, we define their corresponding random variables: C_{bg} is the r.v. representing the length of background collision period, and X_{bg} the length of successful background frame transmission time. When the RTS/CTS mechanism is employed, we have

$$\begin{aligned} C_{bg} &= RTS + EIFS, \\ X_{bg} &= RTS + SIFS + CTS + SIFS + X' \\ &\quad + SIFS + t_{ACK} + DIFS, \end{aligned}$$

and when the RTS/CTS mechanism is not employed, we have

$$\begin{aligned} C_{bg} &= CF + EIFS, \\ X_{bg} &= X' + SIFS + t_{ACK} + DIFS, \end{aligned}$$

where all the terms in Eqs. (28)–(31) are defined in Section II-B. By using the Laplace transform function and its relationship with moment generating function associated with each random variable as done in [11], we have

$$\bar{c}_{bg} = RTS + EIFS, \quad (28)$$

$$\begin{aligned} \bar{x}_{bg} &= RTS + SIFS + CTS + SIFS + \bar{x}' \\ &\quad + SIFS + t_{ACK} + DIFS, \quad (29) \end{aligned}$$

when the RTS/CTS mechanism is used; and

$$\bar{c}_{bg} = \bar{c}' + EIFS, \quad (30)$$

$$\bar{x}_{bg} = \bar{x}' + SIFS + t_{ACK} + DIFS \quad (31)$$

in the other case.

Finally, we can determine $\bar{d} = \ell_{size} \cdot \bar{b}$ in Eq. (27) as follows. Let p represent the probability that collision occurs between one foreground frame and one or more background frames. Recall that b_i is the average backoff window size when the contention window is \widetilde{CW}_i ; i.e., $b_i = \frac{1}{\widetilde{CW}_i} \sum_{i=0}^{\widetilde{CW}_i-1} i = \frac{\widetilde{CW}_i-1}{2}$, and m is the index for the maximum contention window size (in Section II-B). Then we have $\widetilde{CW}_i = 2^i \cdot \widetilde{CW}_0$ for $1 \leq i \leq m$, and

$$\begin{aligned} \bar{d} &= \ell_{size} \cdot \bar{b} = \ell_{size} \cdot E\left[\sum_{i=0}^{\infty} b_i\right] \\ &= \ell_{size} \cdot \left[\sum_{i=0}^{m-1} \left\{ \frac{\widetilde{CW}_i-1}{2} \cdot p^i (1-p) \right\} + \right. \\ &\quad \left. \sum_{i=m}^{\infty} \left\{ \frac{\widetilde{CW}_m-1}{2} \cdot p^i (1-p) \right\} \right] \quad (32) \\ &= \ell_{size} \cdot \left[\frac{\widetilde{CW}_0}{2(1-2p)} \cdot (1-p-p \cdot (2p)^m) - \frac{1}{2} \right]. \end{aligned}$$

Since the collision between foreground and background traffic occurs when one or more background nodes are attempting to transmit their frames when the backoff timer of the foreground node expires. Hence, the collision probability, p , can be expressed as

$$p = P_{collision,bg} + P_{success,bg} = 1 - e^{-\lambda}. \quad (33)$$

The term $\bar{\tau}$ in Eq. (26) is the expected residual service time for background traffic, which can be a collision period or a successful transmission time. Therefore, $\bar{\tau}$ can be expressed as

$$\bar{\tau} = P_{collision,bg} \cdot \left(\frac{\bar{c}_{bg}}{2} + \frac{\sigma_{C_{bg}}^2}{2\bar{c}_{bg}} \right) + P_{success,bg} \cdot \left(\frac{\bar{x}_{bg}}{2} + \frac{\sigma_{X_{bg}}^2}{2\bar{x}_{bg}} \right). \quad (34)$$

Conclusively, we can express the expected value of d_{fg} as follows:

$$\bar{d}_{fg} = \bar{\tau} + \ell_{size} \cdot \left\{ \frac{\widetilde{CW}_0}{2(1-2p)} \cdot (1-p-p \cdot (2p)^m) - \frac{1}{2} \right\} + \bar{x}_{fg}, \quad (35)$$

where $\bar{\tau}$, ℓ_{size} , and $\bar{x}_{fg} = \bar{x}_{bg}$ are given in Eqs. (34), (27), and (29) (or (31)), respectively. The throughput attained by foreground traffic is then given by Eqs. (23) and (35).

IV. THROUGHPUT MODEL FOR BACKGROUND TRAFFIC

The aggregate throughput for background traffic should be determined in both the cases in which foreground traffic is present and is not. Fortunately the throughput under both cases can be determined in the same manner as in our prior work [11] (Section II-B). The only difference is that the number, M , of active nodes (which is needed to compute the attempt rate, λ) is $N-1$ in the latter case, and is N in the former case. The remaining derivation has been given in Section II-B.

V. MODEL VALIDATION

We validate the analytic model derived in Section III via simulation, and compare results against those obtained via packet level simulation and fluid model based simulation. Fig. 6 depicts the throughput versus the total number of nodes, N , in a IEEE 802.11-operated WLAN with the RTS/CTS mechanism ((a)) and without the RTS/CTS mechanism ((b)). Traffic from one of the nodes is considered as the foreground traffic. The packet size 250 bytes (100 slot time).

The upper two curves in Figure 6 represent, respectively the throughput attained by the aggregate traffic (that includes both the background and foreground traffic) in the simulation and the analytic model. We observe that they agree extremely well with each other. The bottom three curves depict, respectively, the analytical result of the throughput attained by the foreground traffic (calculated by Eq. (23)), and the corresponding throughput obtained in packet level simulation and fluid model based simulation. Three curves agree well with one another.

VI. SIMULATION STUDY

We have conducted a simulation study in a variety of network configurations to evaluate the performance of the proposed mixed mode simulation approach in terms of the accuracy and performance as compared with both fluid model based simulation and packet level simulation.

A. Implementation & Configuration

To realize mixed mode simulation, we extend *ns-2* to conduct both packet level simulation and fluid model based simulation. Fluid model based simulation is implemented based on the fluid model derived in [11]. Traffic that is simulated at the packet level competes, in compliance with the interaction model derived in Section III, with traffic that is simulated in the fluid mode for the current bandwidth available in the WLAN.

Extension to *ns-2* simulator: To focus on the effect of data transmission-related activities and to filter out other second-order effects in the simulation study, we deliberately leave out several protocol operations in IEEE 802.11, e.g., power saving, beaconing, association and re-association between wireless nodes and access points, and hidden terminal effects. Specifically, we extend *ns-2* as follows.

First, we introduce a virtual wireless LAN node, with which all the wireless nodes communicate with each other through this virtual node. The wireless LAN node uses a static routing algorithm, and also uses a static ARP table. The control overhead considered in the simulation study is therefore solely due to data transmission-related activities (overheads incurred in transmitting RTS/CTS/ACK packets). Second, in order to construct fluid chunks as the abstract simulation units, we exploit the time stepping techniques introduced in [11], [21]. With the time stepping technique, we introduce a new packet type, called the *fluid rate* packet which describes fluid chunks of one flow within one time step. Third, we also include in *ns-2* (i) several new protocol modules that correspond to the fluid model based version of existing link, MAC, physical, and channel layer modules, and (ii) a new module, called *fluid*

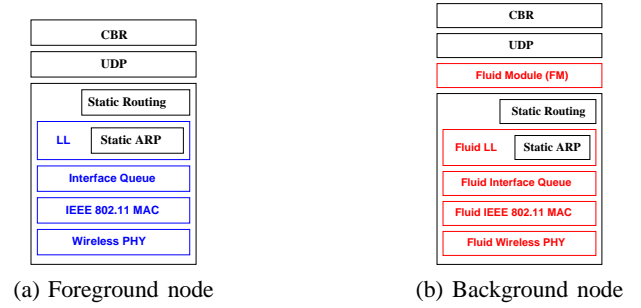

Fig. 7. Protocol stacks for packet level simulation and fluid model based simulation.

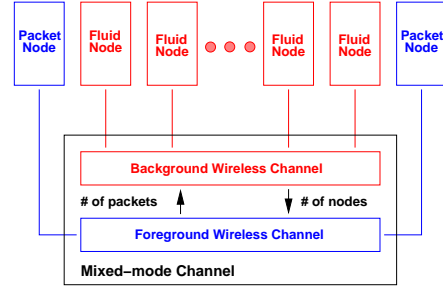

Fig. 8. The configuration for mixed mode simulation.

module, that translates a cluster of packets into a *fluid rate* packet or vice versa [11]. Last, we extend *ns-2* to include a *modified* packet level version of existing link, MAC, physical, and channel modules, all of which are adapted to interact with fluid model based simulation according to the proposed interaction model (derived in Section III).

Fig. 7 (a) and (b) gives, respectively, the protocol stack in the nodes under packet level simulation and under fluid model based simulation. Note that both the protocol stacks exist and operate simultaneously in mixed mode simulation.

Fig. 8 depicts the interaction between fluid model based simulation and packet level simulation in the mixed mode simulation framework. The interaction takes place in the *mixed mode channel*, which consists of the fluid model based wireless channel (for background traffic) and the packet level wireless channel (for foreground traffic). The former channel computes the throughput (allocated to background traffic) according to the total number of active nodes (including the foreground nodes if it exists in a time step). The latter channel is based on the throughput model derived in Section III, and computes the throughput attained by the foreground traffic (which is then used to schedule foreground frames).

Fig. 9 gives a simplified version of mixed mode simulation, called *foreground only mixed mode simulation*. In this simulation mode, background traffic virtually exist within *ns-2*. With this configuration, only the packet level wireless channel exists, and the simulation engine *virtually* provides the number of active background nodes for the foreground wireless channel, so as for the latter to estimate the throughput attained by the foreground traffic.

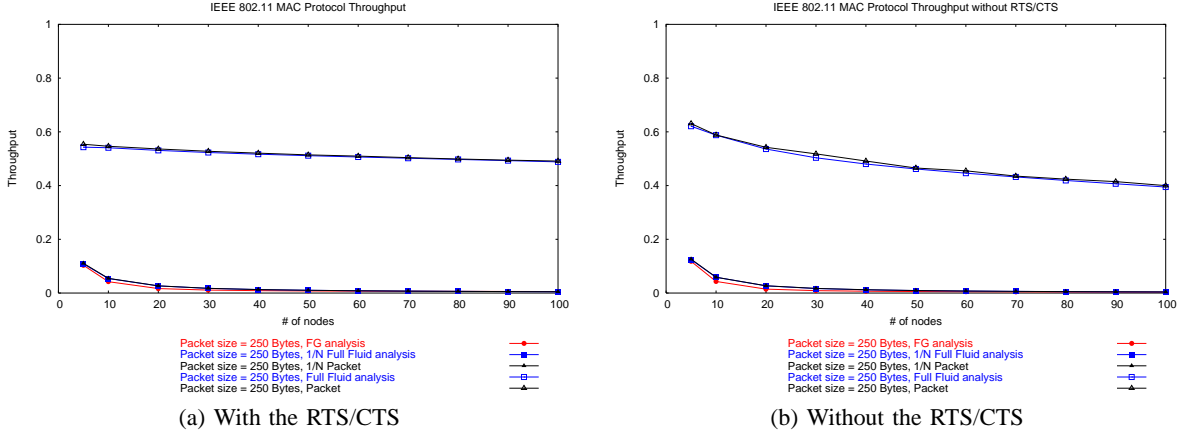

Fig. 6. Aggregate throughput and throughput attained by the foreground traffic obtained in the simulation and the analytic model. The packet size is 250 bytes.

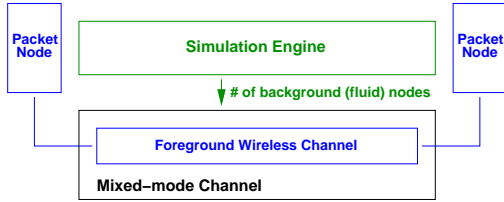

Fig. 9. The configuration for foreground mode only simulation.

B. Performance Evaluation

The experiments have been carried out under two different IEEE 802.11 operational modes: one with the RTS/CTS mechanism and the other without, and in each instance of fluid model based simulation, with a variety of time step values. However, due to the space limit, we only present results with the RTS/CTS mechanism. All the simulations are conducted on Linux 2.4.18 on a Pentium 4-1.9 GHz PC with 1 GBytes memory and with 2 GBytes swap memory. We use *ns-2.1b9a*, but upgrade the code of the IEEE 802.11 MAC layer with that available in *ns-2.26*. Each simulation run lasts for 60 simulation seconds. (Note that simulation study in [11] uses *ns-2.1b9*, and hence simulation results relevant to fluid model based simulation might be different, especially in terms of execution time.)

1) *Performance in Terms of Relative Errors*: Mixed mode simulation inevitably trades accuracy for performance efficiency since all the traffic except the foreground traffic is abstracted in fluid model based simulation. In this section, we quantitatively evaluate the discrepancy between results obtained in mixed mode simulation and those respectively obtained in packet level simulation and in fluid model based simulation. The comparison is made in two steps: in the first step, we study the discrepancy in the aggregate throughput (as a percentage of the maximum bandwidth of the WLAN) between results obtained in fluid model based simulation and those in packet level simulation. The purpose of this step is to verify that fluid model based simulation accurately characterizes the background traffic. In the second step, we study the discrepancy in the throughput attained by the foreground flow,

between results obtained in mixed mode simulation, packet mode simulation, and fluid mode simulation. The purpose of the second step is to validate that the foreground flow (simulated in the packet mode) attains in a fair manner the throughput in the wireless LAN with multiple competing flows.

Fig. 10 compares (i) the aggregate throughput (relative to protocol capacity) between packet level and fluid model based simulation and (ii) the throughput attained by the foreground traffic (in mixed mode simulation) and the average throughput obtained by a flow in packet level simulation and fluid model based simulation. In both cases, the error discrepancy is less than 2 % of the protocol capacity as far as the time step value is appropriately chosen. In particular, the throughput attained by the foreground flow agrees extremely well with the average per-flow throughput in pure packet level simulation or pure fluid model based simulation. We also observe that for simulation results without the RTS/CTS mechanism, the error discrepancy also falls within 2 %.

Results in WLANs of extremely large sizes: To investigate whether or not the error discrepancy is still within the 2 % bound, when the size of the WLAN grows, the same experiments have been conducted in a WLAN with a (perhaps unreasonably) large number of nodes. Fig. 11 gives the protocol capacity (both fluid model based and mixed mode simulation) versus the number of nodes in a WLAN of size up to 1000 nodes, when the packet size is fixed at 25 (10) and 250 bytes (100 slot times) respectively, and when the time step value is 0.1 (sec.). Again, the relative error discrepancy in both the aggregate throughput and the foreground throughput (both relative to the maximum protocol capacity) falls within 2 %.

2) *Performance in Terms of Execution Time*: This section presents the performance improvement (in terms of execution time) that mixed mode simulation makes, as compared with packet level simulation. We also study the overhead incurred in mixed mode simulation which does not exist in fluid model based simulation.

Fig. 12 depicts the execution time versus the number of nodes among packet level simulation, fluid model based mixed mode simulation (Fig. 8), and the simplified version of mixed

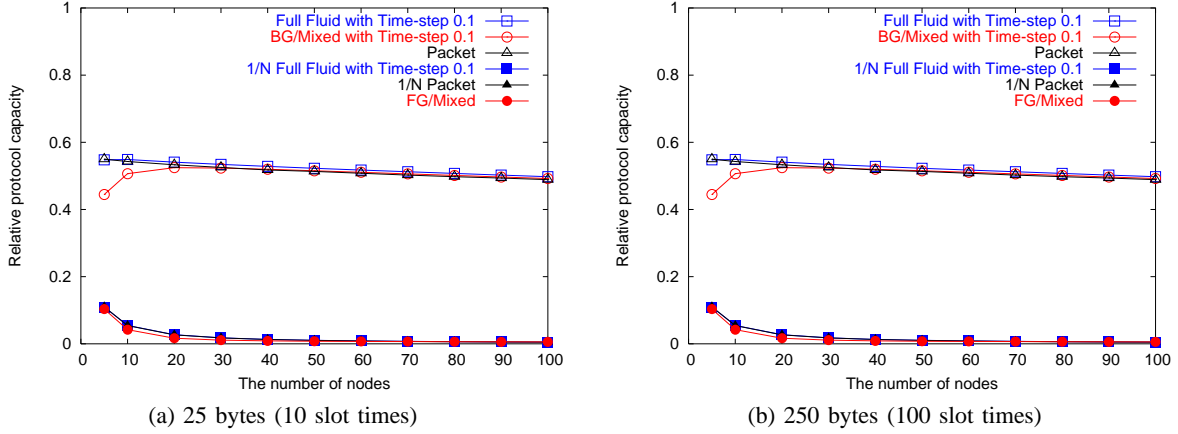

Fig. 10. Aggregate throughput and throughput attained by the foreground traffic versus the number of nodes in an IEEE 802.11-operated WLAN with the RTS/CTS mechanism. The time step value is 0.1 (sec.). Packet size are 25 ((a)) and 250 bytes ((b)), respectively. Curves labeled with “Full Fluid,” “BG/Mixed,” and “Packet” corresponds to the aggregate throughput results in fluid model based simulation, mixed mode simulation, and packet level simulation, respectively. Curves labeled with “ $\frac{1}{N}$ Full Fluid,” “ $\frac{1}{N}$ Packet,” and “FG/Mixed” correspond to the foreground throughput results in fluid model based simulation, packet level simulation, and mixed mode simulation.

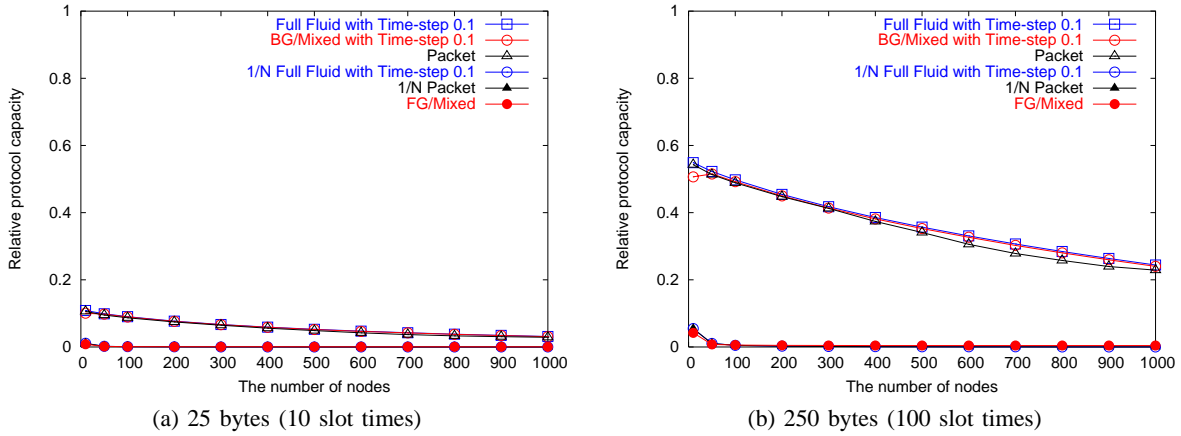

Fig. 11. Aggregate throughput and throughput attained by the foreground traffic versus the number of nodes in an IEEE 802.11-operated WLAN with the RTS/CTS mechanism. The time step value is 0.1 (sec.). Packet size are 25 ((a)) and 250 bytes ((b)), respectively.

mode simulation (Fig. 9). The RTS/CTS mechanism is used, the time-step value is set to 0.1 (sec.) and the packet size is 25 and 250 bytes, respectively. Packet level simulation incurs the most execution time. Both mixed mode simulation and fluid model based simulation achieve about two orders of magnitude of improvement as compared to packet level simulation. Mixed mode simulation (labeled as BG/MIXED) is slightly slower than fluid model based simulation (labeled as Full Fluid), due to the overhead incurred in its interaction with the packet level simulation. On the other hand, the simplified version of mixed mode simulation (labeled as FG/MIXED), in which background traffic virtually exists, performs the best.

Fig. 13 evaluates the effect of time step values on the performance of mixed mode simulation in the same configuration used in Fig. 12. Four different values of time steps are used. We observe approximately two orders of magnitude improvement in mixed mode simulations (with the time step values varying from 0.01 to 1.0), and more than two orders of magnitude improvement in the simplified version of mixed mode simulation. The improvement is especially pronounced

when the number of nodes increases or the packet size decreases. This is because under these conditions the packet level simulation generates more events to be processed.

Results in WLANs of extremely large sizes: Fig. 14 gives the execution time versus the number of nodes in WLANs (of up to 1000 nodes) with the RTS/CTS mechanism, under packet level simulation, fluid model based simulation, mixed mode simulation, and the simplified version of mixed mode simulation. The time-step value is set to 0.1 (sec.), and the packet size is 25 (10) and 250 bytes (100 slot times), respectively. The same observation as in Fig. 12 can be made.

Fig. 15 evaluates the effect of time step values on the performance of mixed mode simulation in the same configuration used in Fig. 14. Four different values of time steps are used. The same observation as in Fig. 13 can be made: as compared to packet level simulation, approximately two orders of magnitude improvement has been made in mixed mode simulations (with the time step values varying from 0.01 to 1.0), and more than two orders of magnitude improvement in the simplified version of mixed mode simulation.

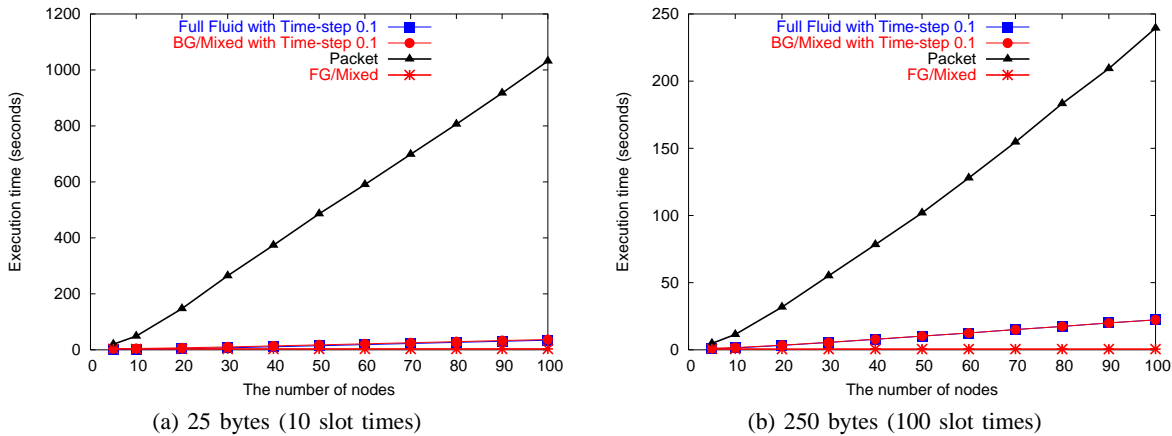

Fig. 12. Execution time under (i) packet level simulation, (ii) fluid model based simulation, (iii) mixed mode simulation, and (iv) a simplified version of mixed mode simulation, in IEEE 802.11 operated WLANs with the RTS/CTS mechanism. The number of nodes increases up to 100 nodes, the time-step value is 0.1 (sec.), the packet size is 25 (10) and 250 bytes (100 slot times), respectively.

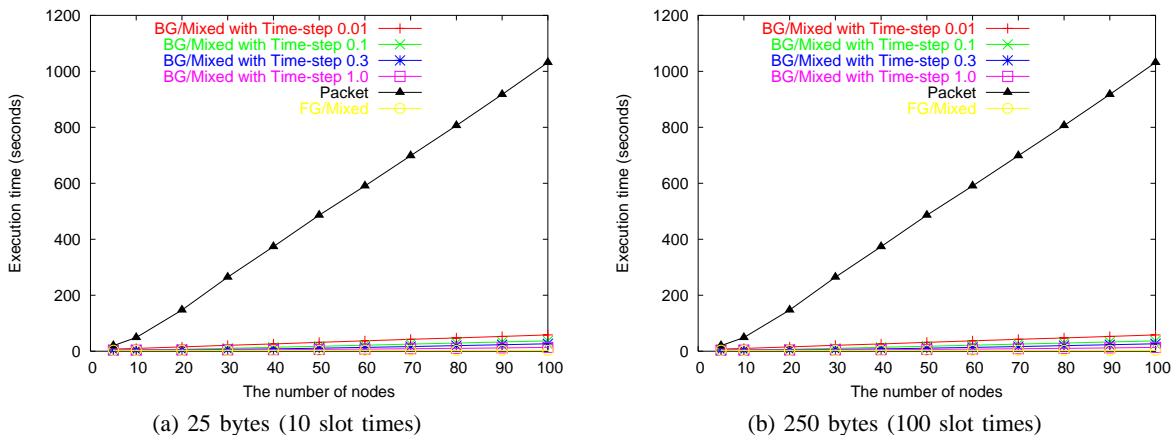

Fig. 13. Effect of time step values on the performance of mixed mode simulation. The number of nodes increases up to 100 nodes, the packet size is 25 (10) and 250 bytes (100 slot times), respectively, and the IEEE 802.11-operated WLAN is equipped with the RTS/CTS mechanism.

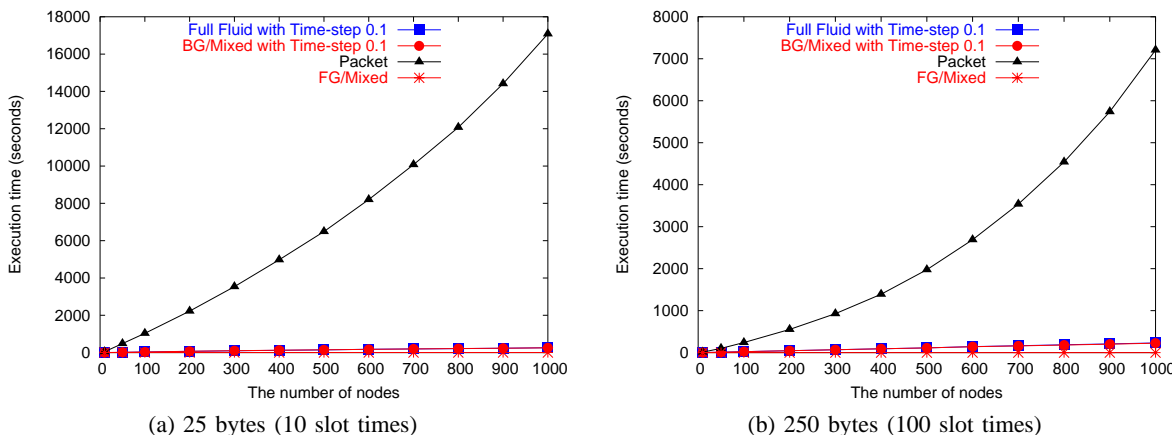

Fig. 14. Execution time under (i) packet level simulation, (ii) fluid model based simulation, (iii) mixed mode simulation, and (iv) a simplified version of mixed mode simulation, in IEEE 802.11 operated WLANs (up to 1000 nodes) with the RTS/CTS mechanism. The time-step value is 0.1 (sec.), and the packet size is 25 (10) and 250 bytes (100 slot times), respectively.

Results in multiple-WLAN, multiple-application scenarios: To study whether or not the performance improvement levels off as the network size further increases, we evaluate the performance for large scale networks in which multiple

WLANs (each of which is made up of multiple nodes) exist and are interconnected via “bridge” wireless nodes. Bridge nodes are connected by wired links in a ring structure (Fig. 16). In this configuration, both the number of applications per node

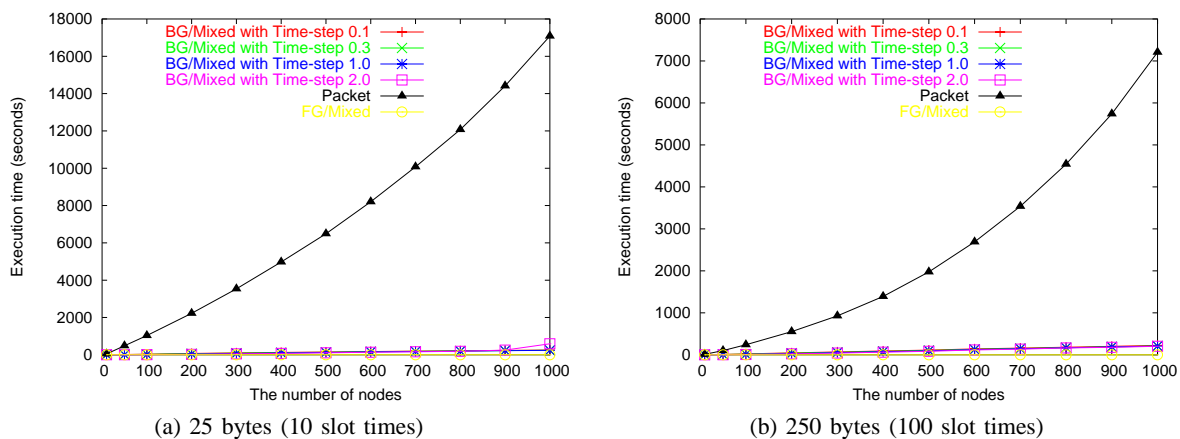

Fig. 15. Effect of time step values on the performance of mixed mode simulation. The number of nodes increases up to 1000 nodes, the packet size is 25 (10) and 250 bytes (100 slot times), respectively, and the IEEE 802.11-operated WLAN is equipped with the RTS/CTS mechanism.

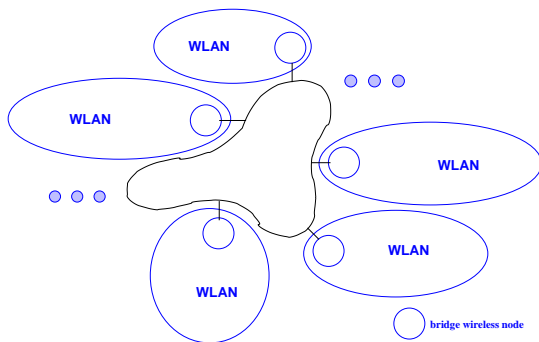

Fig. 16. Multiple WLANs interconnected via bridge wireless nodes.

and the number of WLANs in the network to be simulated may vary.

Fig. 17 gives the execution time versus the number of applications per node, in the large hybrid network (composed of 5 WLANs, each of which consists of 20 nodes), under packet level simulation, fluid model based simulation, mixed mode simulation, and the simplified version of mixed mode simulation. The packet size is fixed at 25 (10) and 250 bytes (100 slot times), respectively. The same observation as in Figs. 12 and 14 can be made.

Fig. 18 evaluates the effect of time step values on the performance of mixed mode simulation in the same configuration used in Fig. 17. Four different values of time steps are used. The same observation as in Figs. 13–15 can be made.

VII. CONCLUSION

In this paper, we have developed a mixed mode simulation framework for IEEE 802.11-operated WLANs, that combines the performance gains of fluid model based simulation with the accuracy and packet level details afforded by packet level simulation. In particular, leveraging on the fluid model derived in [11], we propose the interaction model between the foreground flow and the other background flows, in view of their achievable throughput. This enables packet level simulation to co-exist and interact with fluid model based simulation within one simulation framework.

We validate the throughput model that characterize the interaction between the foreground traffic and the background traffic by comparing its numerical results with those obtained in packet level simulation and fluid model based simulation. Then we implement mixed mode simulation for IEEE 802.11-operated WLANs in *ns-2*, and conduct a comprehensive simulation study to evaluate mixed mode simulation in terms of the speed-up in the execution time and the error discrepancy (the difference between the results obtained in mixed mode simulation and those obtained in other simulation modes). Simulation results indicate that it is feasible to blend fluid model based simulation into packet level simulation, and the performance improvement is significant while the accuracy and the packet level details desired are not compromised. Mixed mode simulation achieves two orders of magnitude improvement in terms of execution times as compared with packet level simulation. The improvement is even more pronounced, when the number of wireless nodes increases, or when the number of applications that run on each node increases. The relative error, on the other hand, falls within 2 % in all the cases as far as the time step value is appropriately chosen.

As part of our future work, we would like to extend the interaction model to accommodate two or more foreground flows. We would also like to extend the derived throughput model for foreground traffic, in order to take into account of the hidden/exposed terminal problem, external interference, self interference and overlapping channels. This would allow us to extend mixed mode simulation to not only WLANs, but also mobile ad hoc networks (MANETs).

REFERENCES

- [1] F. Baccelli, G. Cohen, G. J. Olsder, and J.-P. Quadrat. *Synchronization and Linearity*. John Wiley & Sons, 1992.
- [2] U. Berkeley, LBL, USC/ISI, and X. PARC. *The ns Manual*. <http://www-mash.cs.berkeley.edu/ns/>, April 2002.
- [3] G. Bianchi. Performance analysis of the ieee 802.11 distributed coordination function. *IEEE Journal on Selected Areas in Communications*, 18(3), March 2000.
- [4] J.-Y. L. Boudec and P. Thiran. *Network Calculus*. Springer-Verlag, 2002.
- [5] F. Calz, M. Conti, and E. Gregori. Tuning of the ieee 802.11 protocol to achieve a theoretical throughput limit. *IEEE/ACM Transactions on Networking*, 8(6), December 2000.

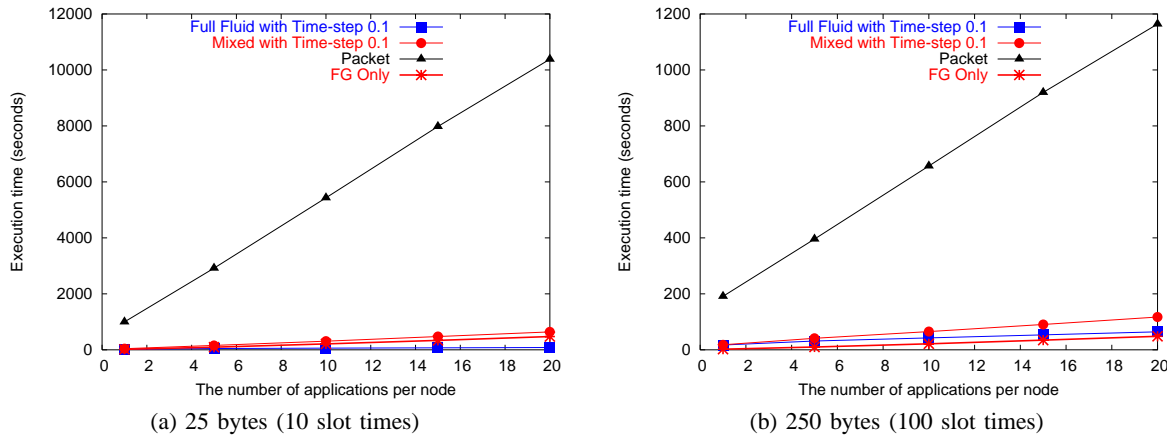

Fig. 17. Execution time under (i) packet level simulation, (ii) fluid model based simulation, (iii) mixed mode simulation, and (iv) a simplified version of mixed mode simulation, in a large hybrid network (composed of 5 WLANs, each of which consists of 20 nodes). The time-step value is 0.1 (sec.), and the packet size is 25 (10) and 250 bytes (100 slot times), respectively.

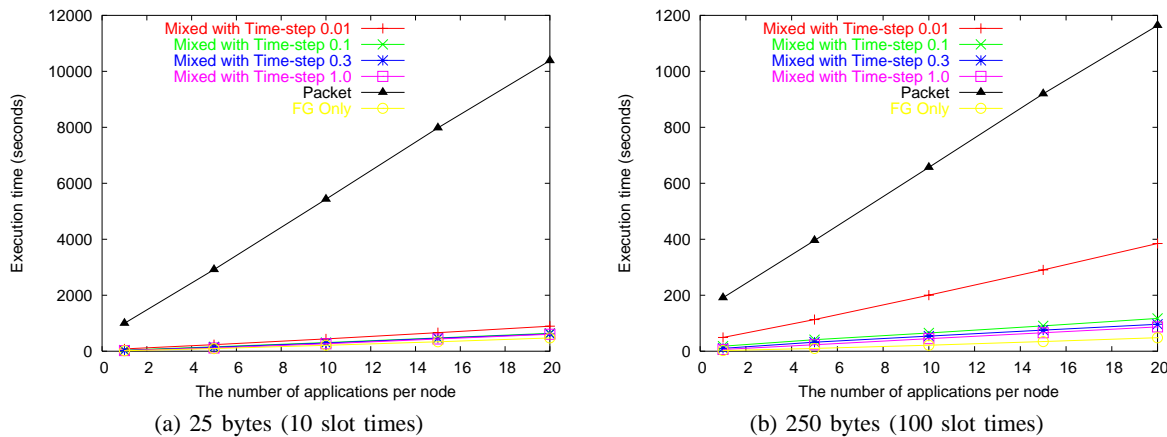

Fig. 18. Effect of time step values on the performance of mixed mode simulation. The hybrid network is composed of 5 WLANs (equipped with the RTS/CTS mechanism), each of which contains 20 wireless nodes. The packet size is 25 (10) and 250 bytes (100 slot times), respectively.

- [6] C.-S. Chang. *Performance Guarantees in Communication Networks*. Springer-Verlag, 2000.
- [7] C. H. Foh and M. Zukerman. Performance analysis of the IEEE 802.11 MAC protocol. In *Proceedings of the EW 2002 Conference, (Italy)*, February 2002.
- [8] Y. Gu, Y. Liu, and D. Towsley. On Integrating Fluid Models with Packet Simulation. In *Proceedings of IEEE INFOCOM 2004, (Hong Kong, China)*, March 2004.
- [9] Y. Guo, W. Gong, and D. Towsley. Time-stepped hybrid simulation (tshs) for large scale networks. In *Proceedings of IEEE INFOCOM 2000, (Tel-Aviv, Israel)*, March 2000.
- [10] T. S. Ho and K. C. Chen. Performance evaluation and enhancement of CSMA/CA MAC protocol for 802.11 wireless LANs. In *Proceedings of IEEE PIMRC 1996, (Taipei, Taiwan)*, October 1996.
- [11] H. Kim and J. C. Hou. A Fast Simulation Framework for IEEE 802.11-Operated WLANs. In *Proceedings of ACM SIGMETRICS 2004, (New York, New York)*, June 2004.
- [12] H. Kim and J. C. Hou. Network Calculus Based Simulation for TCP Congestion Control: Theorems, Implementation and Evaluation. In *Proceedings of IEEE INFOCOM 2004, (Hong Kong, China)*, March 2004.
- [13] B. Liu, D. R. Figueiredo, Y. Guo, J. Kurose, and D. Towsley. Fluid models and solutions for large-scale IP networks. In *Proceedings of IEEE INFOCOM 2001, (Anchorage, Alaska)*, April 2001.
- [14] Y. Liu, F. L. Presti, V. Misra, D. Towsley, and Y. Gu. Fluid models and solutions for large-scale IP networks. In *Proceedings of ACM SIGMETRICS 2003, (San Diego, California)*, June 2003.
- [15] N. Milidrag, G. Kesidis, and M. Devetsikiotis. An overview of fluid-based quick simulation techniques for large packet switched communication networks. In *Proceedings of SPIE ITCOM 2001, (Denver, Colorado)*, August 2001.
- [16] V. Misra, M. Gong, and D. Towsley. A fluid-based analysis of a network of AQM routers supporting TCP flows with an application to RED. In *Proceedings of ACM SIGCOMM 2000, (Stockholm, Sweden)*, September 2000.
- [17] V. Misra, W. Gong, and D. Towsley. Stochastic differential equation modeling and analysis of TCP window size behavior. In *Proceedings of Performance 1999, (Istanbul, Turkey)*, October 1999.
- [18] J. Padhye, V. Firoiu, D. Towsley, and J. Kurose. Modeling TCP throughput: A simple model and its empirical validation. In *Proceedings of ACM SIGCOMM 1998, (Vancouver, Canada)*, September 1999.
- [19] S. Shakkottai and R. Srikant. How good are deterministic fluid models of internet congestion control? In *Proceedings of IEEE INFOCOM 2002, (New York, New York)*, June 2002.
- [20] H. Wu, Y. Peng, K. Long, S. Cheng, and J. Ma. Performance of reliable transport protocol over IEEE 802.11 wireless LAN: Analysis and enhancement. In *Proceedings of IEEE INFOCOM 2002, (New York, New York)*, June 2002.
- [21] Y. Wu and W. Gong. Time stepped simulation of queuing systems. In *Technical Report, Department of Electrical and Computer Engineering, University of Massachusetts*, 2001.