

97

COO-1199-17

Illinois State Water Survey
at the
University of Illinois
Urbana, Illinois

STUDY OF RAINOUT OF RADIOACTIVITY IN ILLINOIS

Seventh Progress Report
Contract Number AT(11-1)-1199
November 1968

Sponsored by

United States Atomic Energy Commission
Fallout Studies Branch
Division of Biology and Medicine
Washington, D. C.

Glenn E. Stout
Project Director

CONTENTS

	Page
INTRODUCTION	1
ACKNOWLEDGMENTS	2
TRACING TROPOSPHERIC RADIOACTIVE DEBRIS BY ISENTROPIC TRAJECTORIES	
By J. W. Wilson	3
Introduction	3
Method	3
Conclusions	4
SUBSYNOPTIC UPPER AND MIDDLE TROPOSPHERIC CIRCULATIONS	
By J. W. Wilson	5
Introduction	5
Data and Analysis	5
AIRBORNE COLLECTION OF ATMOSPHERIC TRACERS	
By J. W. Wilson	7
Introduction	7
Objectives of the State Water Survey	7
Equipment	8
Data Collection	8
PARTICULATE WASHOUT RESEARCH	
By W. E. Bradley	11
Introduction	11
Methods	11
REFERENCES	14
APPENDICES	
A. The Relationship Between the Radioactivity in Surface Air and in precipitation - By W, E. Bradley	
B. The Vertical Distribution of Tritium in Water Vapor in the Lower Troposphere - By W. E. Bradley	
C. Reports prepared under the Contract Number AT(11-1)-1199 U. S. Atomic Energy Commission	

INTRODUCTION

The research during 1968 centered on the completion of the isentropic trajectory work and the initiation of three additional studies related to the washout and rainout of radioactive debris. The new studies involve the investigation of atmospheric motions on a subsynoptic scale and laboratory and field research on the washout and rainout of submicron aerosol particulates.

The case studies involving the analysis of air trajectories at various levels between the surface and 200 mb have been completed. A detailed report of the results has been prepared and submitted as Research Report No. 3 on this contract. A summary of the major findings is found in the following report.

The isentropic trajectory work prompted the search for a mechanism on a smaller scale which might be responsible for the distribution of radioactive material in the low and middle troposphere. Analysis techniques were developed and selected cases were chosen from the National Severe Storms Laboratory library of network data. The initial work and progress on the study follows in this report.

A preliminary attempt was made, in collaboration with Prof. A. N. Dingle of the University of Michigan, to ascertain the particle size contained in the effluent of burning flares. The flares contained a unique element, indium, to be used as a tracer for convective cloud motions and as an aid toward the understanding of some of the cloud physics processes in such clouds. The purpose of this project was to determine, from the particle size, by which of several possible mechanisms the tracer material is removed from a precipitating cloud. The final results from this work are dependent upon the completion of the attendant microscopy work at the University of Michigan.

As an adjunct to the field work on the washout problem, laboratory studies have been initiated to examine the collection efficiencies of raindrops for various aerosols under controlled conditions. During the first year of effort a raindrop-fall chamber was constructed to assure that the drops have reached terminal velocity prior to impaction with the aerosol. The final chamber was constructed from aluminum in the form of a cylinder approximately one meter in diameter and over 13 meters in height. An aerosol generator was designed and built for the production of submicron polystyrene aerosol. A

feasibility study on the usefulness of bacteria as an aerosol was undertaken and completed. Various bacteria will be used as the experimental work progresses. The results from this work will have a direct bearing on the field experiments and will provide necessary data for the mathematical modeling of the removal of atmospheric aerosols by precipitation processes.

ACKNOWLEDGMENTS

The authors wish to express their appreciation to Prof. A. N. Dingle of the University of Michigan for the generous loan of the electrostatic precipitator. This proved to be a vital tool in both the laboratory work and the field program. The National Severe Storms Laboratory, ESSA, is also acknowledged for supplying the data used in the subsynoptic portion of the work.

TRACING TROPOSPHERIC RADIOACTIVE DEBRIS
BY ISENTROPIC TRAJECTORIES

John W. Wilson

Introduction

The purpose of this study was to trace the air from a particular storm system for 12 to 36 hours prior to the rainout of radioactive debris from the storms. The air trajectories should offer evidence as to whether stratospheric air entered the storm, thus possibly accounting for the large bursts of radioactivity observed in rainwater by Huff (1965). A study of the storm systems of 10 June 1963 and 1 July 1963 has been presented by Wilson and Jones (1968). A summary of that study is presented here.

A parcel of air covering a 120 x 120 mile square centered on a 400 sq mi raingage network at the time of the rain was traced backward in time to determine the position of the contamination prior to the time of rain.

Method

Upper air data from the United States for all available synoptic hours (0000, 0600, 1200, 1800 GMT) in the period 36 hours prior to the time of interest were processed by Danielsen's isentropic analysis computer program (Duquet, 1964). This program gives potential temperatures, mixing ratios, relative humidities, streamfunctions, and winds for all reported heights up to 100 mb. Pressures, temperatures, relative humidities, mixing ratios, streamfunctions, and winds are also computed for isentropic surfaces at 5°K intervals from 295° to 400°K.

From the computer data, streamfunction and pressure maps were plotted and analyzed for isentropic levels of 305°K through 340°K, inclusive. This was done for 0000 GMT and 1200 GMT on both the day of interest and the preceding day. Each analyzed map was then digitized using a 21 x 21 JNWP grid,

Streamfunctions, winds, vorticities, deformations, and trajectory endpoints were computed for 3-hour intervals by Danielsen's isentropic trajectory program (Danielsen, 1966), which solves the balance equation to obtain the closest possible approximation to the actual distribution of streamlines and isotachs. The program can process a 12-hour period of data

for one isentropic level. Since 36 hours of trajectories for eight levels were desired, 24 computer runs were required for each case study. Three-hour trajectory endpoints were then plotted for each gridpoint for a 12-hour time interval.

The actual tracing of the air was accomplished by following the corners on the large square for 12 hours upwind along a trajectory. Placing the analyzed pressure map under the boundaries of the air parcel located the pressure at each corner. After tracing the air for 12 hours, the process was repeated with the appropriate pressure map. The vertical movement of each corner was then found by subtracting pressures.

Conclusions

In neither case examined was there any evidence of stratosphere-troposphere exchange prior to rainout of the radioactive debris over Illinois. On 10 June 1963 several thunderstorms penetrated the tropopause while in the vicinity of the ramgange network in east central Illinois. This could explain the unusually high contamination in the rainwater. Much of the high radioactivity was associated with light rain (Huff, 1965). This could possibly have scavenged particles previously evaporated by earlier storms that may have penetrated into the stratosphere. On 1 July 1963 only one storm penetrated into the stratosphere over the network. Low values of potential vorticity in both cases suggest that highly radioactive stratospheric air did not enter the rainwater at low levels. Low-level input of tropospheric air by the mechanism proposed by Gatz (1967) could have occurred also; this could not be determined, however, because of the lack of lower level wind data.

The trajectories produced by the computer were compared to trajectories derived from two methods using hand analysis. The results, based upon the theory of conservation of potential vorticity, indicated that the machine-produced trajectories were more accurate.

The trajectories used in the case studies are therefore accurate within the limits of error which were approximately 100 miles for 36 hours of travel. If all of the debris measured did not result from thunderstorms penetrating the tropopause over Illinois, smaller mesoscale circulations must be assumed to have caused the remainder of the contamination.

SUBSYNOPTIC UPPER AND MIDDLE TROPOSPHERIC CIRCULATIONS

John W. Wilson

Introduction

A diagnostic study of subsynoptic local circulations in the upper and middle troposphere was undertaken in order to improve estimates of the rate of diffusion of radioactive material under different conditions of large-scale flow. This study involves two phases. Description of the horizontal extent and time-dependence of vertically-oriented mesoscale oscillations of ageostrophic winds and vertical velocity, such as described by Kreitzberg (1966), comprise the first phase. Model computations of the vertical transport of radioactivity in these circulations are the second part of the work.

During 1968 work was to be shifted to the first phase of this study as other work was completed (see the first section of this report). Data were obtained from the National Severe Storms Laboratory (NSSL) mesoscale radiosonde network located in Oklahoma. Balloon releases at 90-minute intervals for up to 10 stations were made during the spring of 1967; computer processed radiosondes are available for nine of the cases.

Data and Analysis

Two cases were chosen from the 1967 NSSL data for study. On 25 April an occluded front and its accompanying low pressure area crossed Oklahoma, presenting a surface situation similar to one studied by Kreitzberg (1966). On 30 May a squall line crossed Oklahoma, spawning a thunderstorm into which indium tracer was placed. Analysis could possibly explain the behavior of the indium observed by Dingle (1968).

The 43 soundings of 25 April have been plotted and partially analyzed for the six release times. Two computer programs have been developed. One computes the static stability (-90/9p) for each radiosonde contact point and graphs it against height of the balloon. The other computes vertical velocity w from the expression

$$w_2 = w_1 + \frac{1}{g} \left(\frac{1}{\rho_2} \Delta_2 - \frac{1}{\rho_1} \Delta_1 \right) (P_2 - P_1),$$

where subscript 2 is at a higher elevation than subscript 1. The divergence is calculated by measuring the inflow and outflow of a triangular area (Bellamy, 1919). Divergences have been computed for 18 triangles over the network for one time period and are being used to check the vertical velocity program.

As the analysis progresses, both horizontal and cross-sectional maps will be examined in isobaric and isentropic frames of reference. Cases in addition to those mentioned may be undertaken pending the outcome of the first two.

It should be mentioned that the meteorologist responsible for completing this phase of the research incurred an unavoidable 3-month military leave of absence in early 1968. This explains the lack of conclusive results during the current contract year.

AIRBORNE COLLECTION OF ATMOSPHERIC TRACERS

John W. Wilson

Introduction

A cooperative effort was planned and implemented to determine the particle size distribution of certain tracers used in cloud physics studies. Three organizations were involved: Weather Sciences, Inc. (WSI); the University of Michigan (UM); and the Illinois State Water Survey (ISWS).

The selected tracers were released by WSI into either thunderstorms or clear air. The ISWS collected samples of either rainwater or filtered air while airborne. The surface rainwater was obtained by the UM from a network of surface stations. Laboratory techniques are being applied by the UM to the clear air data to determine the distribution of particle sizes of a particular tracer. Descriptions of the Weather Science operations can be found in Booker et al. (1967), and of the Michigan capabilities in Dingle (1968).

Although the collection technique could be employed with any particulate tracer material, Dingle chose indium because of its low background level and ease of measurement.

Objectives of the State Water Survey

The three objectives of the ISWS Mission were.

1. sample indium in a thunderstorm updraft;
2. sample indium in clear air;
3. sample rainfall from a thunderstorm previously seeded with indium.

During air sampling operations the ISWS aircraft would follow in the wake of the WSI airplane which was burning indium flares. The smoke from the fusees is retained in the wingtip vortices of the lead plane; if the collecting aircraft remains at 1/4 to 1 mile back and in the turbulence, Tracer material will enter the samplers.

In a thunderstorm situation the WSI plane would first map the horizontal size and vertical speed of the updraft, rendezvous with the ISWS plane in the updraft, and begin seeding. The seeding was to begin approximately 20 minutes

upstream from the UM field station. This is the estimated residence time for the tracer to remain in the storm (Dingle, 1968), and should be sufficient for tracer-impregnated rain to fall into the collecting apparatus.

The third objective was to be accomplished only if the first two were successful. The WSI aircraft would seed a thunderstorm updraft with indium, then leave the area. The ISWS plane was to begin sampling rainwater by flying parallel to and in the rain curtain for as long as possible. By noting geographical location and changing sample bottles often, temporal and spatial distributions of indium could be found.

Equipment

The twin-engine Beechcraft N9 887Z was used for this project. It has previously been used by the ISWS to sample both air and water, and needed essentially no modification prior to the flights.

For sampling air, a 1.4-in nozzle placed above the fuselage carries air into the cabin via a 2.5-in pipe. There the flow is channeled into two samplers, using pitot tubes which insure isokinetic flow at an indicated airspeed of 115 mph. Air not passing through the samplers is diverted toward a small opening at the rear of the aircraft, minimizing contamination of the apparatus. Figure 1 shows the instrumentation used in air sampling.

For collecting very small particles (down to much less than 1μ) an electrostatic precipitator was built by the University of Michigan following the plans of Liu and Whitby (1967). Samples are collected on glass microscope slides, which are subjected to chemical treatment and electron microscope analysis. Larger particles ($< 0.5\mu$ to $> 15\mu$) are impacted on the plates of a 6-stage Andersen cascade impactor, also the property of the University of Michigan.

The precipitation collector described by Bradley and Martin (1967) was used to collect rainwater. Since contamination was inevitable when flying through tracer-laden air, the unit was not installed until actually needed.

Data Collection

From 14-24 May 1968, the ISWS aircraft was in Norman, Oklahoma. Three flights were made during that period, but none were in thunderstorm situations because no storms formed upwind of the UM ground sampling network. For this

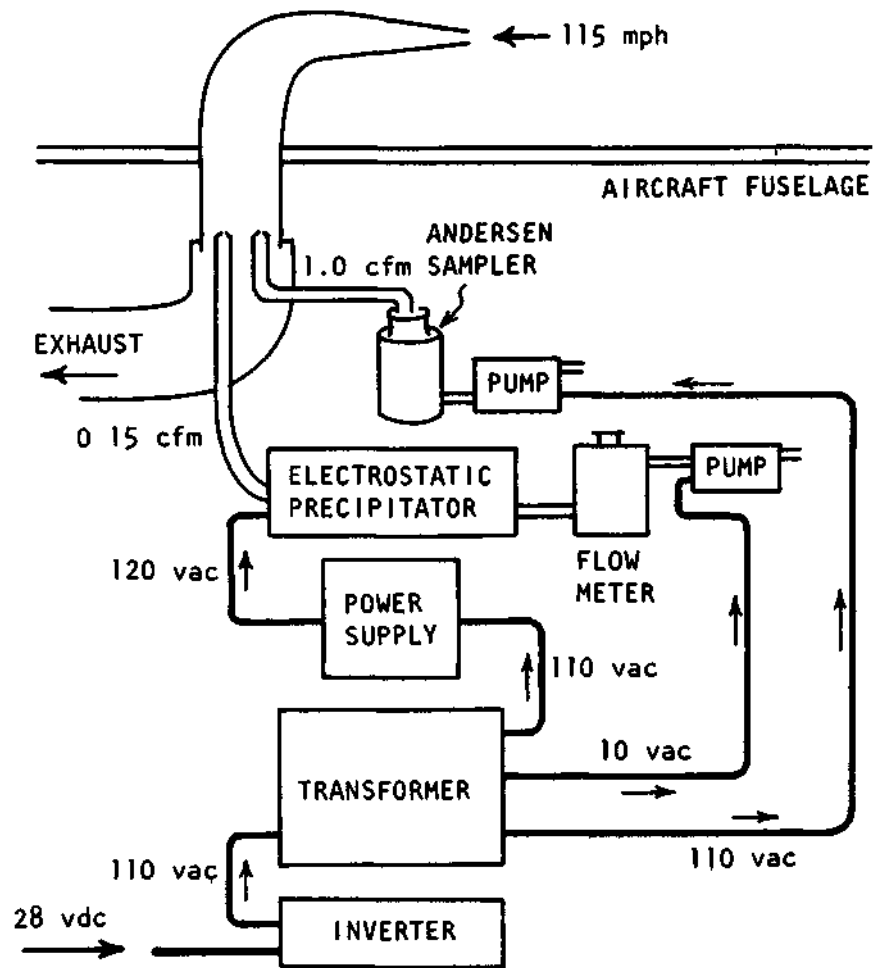

Figure 1 Schematic diagram of air sampling instrumentation in C-45 aircraft.

same reason the precipitation collector was not flown. Air samples were taken of indium tracer though, thus fulfilling the second objective of the work. Table 1 summarizes the flights.

Table 1. Summary of 1968 Oklahoma Tracer Flights.

<u>Date</u>	<u>Tracer</u>	<u>Sample time (min)</u>	<u>Andersen samples</u>	<u>Elect. precip. samples</u>
16 May	AgI	16	6*	5
22 May	Background	20	6	-
23 May	Indium	15	6	5
23 May	AgI	10	6	5

* worked intermittently during flight

If indium would act as a tracer for silver iodide, the particle size distributions of both agents should be known. To test this, both silver iodide and indium were sampled on one flight. The collection plates and slides were changed between tracer flare burns.

Two problems were encountered with the samplers while in Oklahoma. The Andersen sampler operated intermittently on the 16 May flight, but after minor repairs appeared to function the remainder of the time. The trouble was traced to a manufacturing defect, and it is not known if the unit performed as it should. The electrostatic precipitator worked during the flights, but during a post-flight check a leak in the precipitating chamber seal was found. Just what effect this has on the results is not known.

The samples from both air sampling units were given to the University of Michigan for analysis. The results are not available at this writing.

PARTICULATE WASHOUT RESEARCH

Wayne E. Bradley

Introduction

The initial phases of the project have been concerned with the design, construction, and testing of the experimental apparatus as well as with developing sampling techniques. Preliminary tests are now underway with the apparatus shown schematically in figure 2. Details of the construction are as follows.

Methods

A diagram of the aerosol generator is presented in figure 2. The atomizer consists of a tapered glass tube with a concentric #20 hypodermic needle inside, extending just beyond the atomizer nozzle. Compressed air passes through the nozzle at 40-lb pressure while the aerosol solution is injected through the atomizer at 25-lb pressure. In the turbulent atmosphere within the generator chamber, the large drops of the atomized solution are impacted upon the walls while the smaller drops pass freely out the exit into the drying tube. A burner heats the aerosol in the drying tube to the degree necessary to evaporate the water droplets, leaving the polystyrene aerosol individually suspended. The aerosol then passes over two 500-picocurie radioactive grids to neutralize its electrical charge, and into the aerosol drop chamber. Several configurations and sizes of the aerosol chamber as well as different concentrations of aerosol solution have been tried to maximize the aerosol concentration.

After generation the aerosol passes into the scavenging chamber. The tube portion of the chamber is 134 cm long and 15.2 cm in diameter. The aerosol enters the bottom of the chamber, passes upward and vents out the top just below the drop accelerator tube. The drop accelerator tube is 13.1 m long and 80 cm diameter, long enough to allow drops of raindrop size to reach terminal velocity before entering the aerosol chamber. A slight positive flow of air is maintained down the drop shaft to prevent the flow of aerosol into the shaft. This downward flow is accelerated as it passes through a narrow tube just above the aerosol drop chamber.

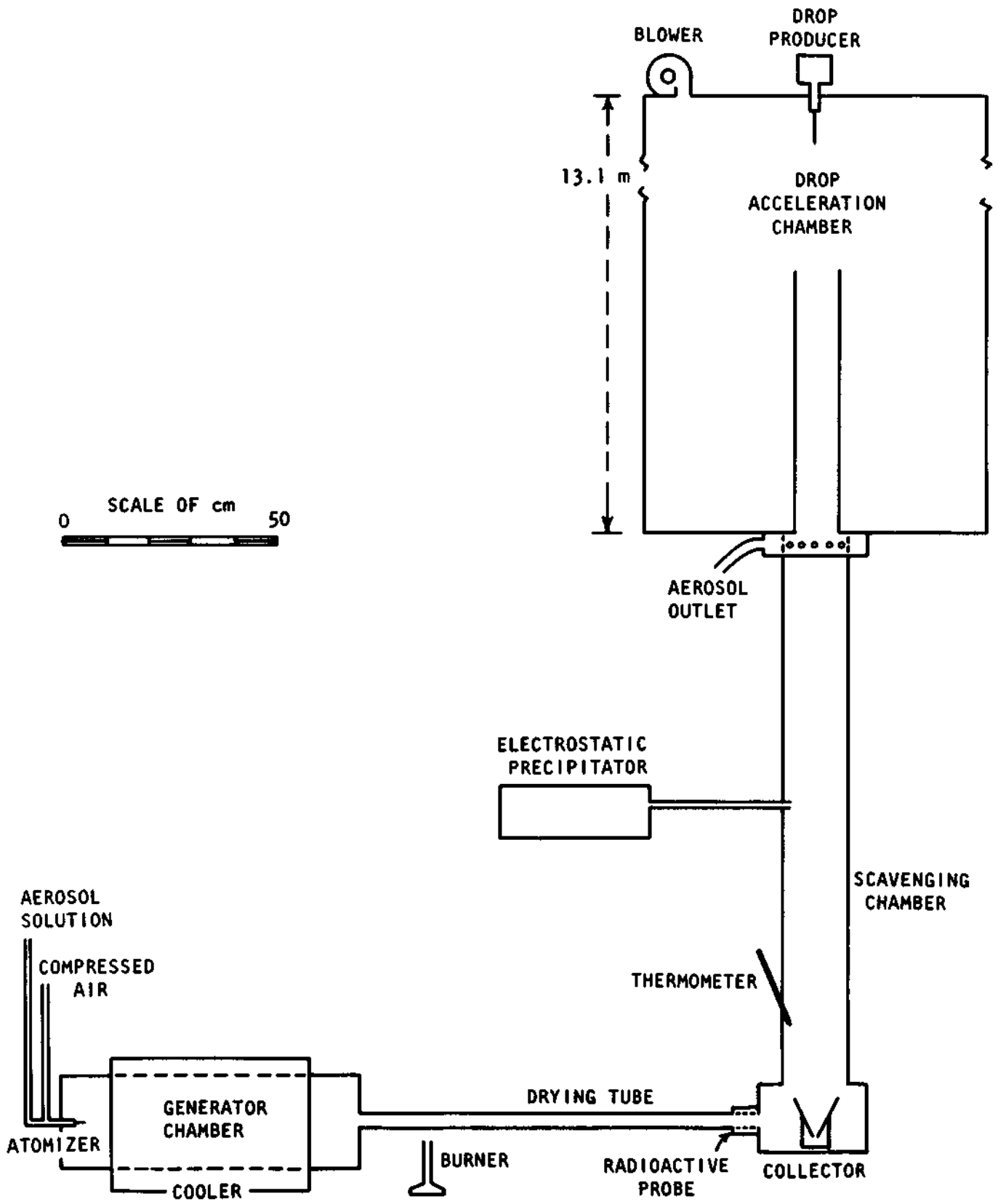

Figure 2. Experimental apparatus for particulate scavenging experiment.

At present the artificial raindrops are being produced by the flow of water through different sizes of hypodermic needles and glass tubes. This technique will not produce drops much smaller than about 1.5-mm diameter, so in the near future a technique will be employed to produce smaller drops.

The aerosol being used at present is formed with polystyrene latex spheres produced by Dow Chemical Company. These spheres are available in a number of submicron sizes of very uniform diameter. The aerosols come in an aqueous suspension which is diluted and atomized to suspend them in the air. Samples of the aerosol are taken for examination with an electrostatic precipitator designed after that of Liu and Whitby (1967) and on loan from the University of Michigan. An optical microscope has been used for counting the particles. At present the aerosol concentrations are of the order of 4×10^3 to 10^4 particles cm^{-3} at the generator outlet, while the concentration of doublets is kept less than 2 or 3 percent. A commercial nebulizer is also being tested for aerosol production, with favorable results.

An investigation is being conducted on the use of microbes as aerosol for scavenging experiments. Microbes have the advantage of being detectable individually by allowing them to grow in an agar solution. The microbes being tested at present are a combination of Aerobacter aerogenes and Escherichia coli. The aerogenes are rod shaped, being 0.5-0.8 μ in diameter and 1-2 μ in length, and the coli are rods 0.5 μ diameter and 1-3 μ in length. Other types of microbes are available in smaller sizes. Each microbe will begin a culture which grows to a diameter of 1-2 mm when incubated overnight in EMB agar.

The microbes could be utilized as follows. A culture of them would be grown, isolated, diluted, and sprayed into the aerosol chamber of the apparatus in such a manner as to suspend them individually. Artificial raindrops would then be allowed to pass through the aerosol. The collected water would be applied to an agar media, and any microbes scavenged by the precipitation would multiply and grow to a visible size when incubated several hours. Initial tests have demonstrated the ability of the microbes to be scavenged by artificial raindrops, but sufficiently controlled conditions have not yet been used to determine collection efficiencies.

REFERENCES

- Bellamy, J. C., 1949: "Objective calculations of divergence, vertical velocity and vorticity," Bull. Amer. Meteorol. Soc., 30, 45-49.
- Bradley, W. E., and G. E. Martin, 1967: "An airborne precipitation collector," J. Appl. Meteorol., 6, 717-723.
- Booker, D. R., L. W. Cooper, and H. E. Hart, 1967: Updraft and Air Flux Studies Utilizing Instrumented Aircraft and Superpressure Balloon - Transponder Systems, Part I, Final Report, National Severe Storms Laboratory Contract E22-79-67 (N), Weather Science, Inc.
- Danielsen, E. F., 1966: Research in Four Dimensional Diagnosis of Cyclonic Storm Cloud Systems, Scientific Report 2, AFCRL Contract AF19(628)-4762, Pennsylvania State University.
- Dingle, A. N., 1968: Rain Scavenging Studies, Progress Report No. 4, AEC Contract AT(11-1)-1407, Department of Meteorology and Oceanography, University of Michigan.
- Duquet, R. T., 1964: Data Processing for Isentropic Analysis, Technical Report 1, AEC Contract AT(30-1)3317, Pennsylvania State University.
- Gatz, D. F., 1967. "Low altitude input of artificial radioactivity to a severe convective storm - comparison with deposition," J. Appl. Meteorol., 6, 530-535.
- Huff, F. A., 1965: Radioactive Rainout Relations in Convective Rainstorms, Research Report 1, AEC Contract AT(11-1)-1199, Ill. State Water Survey.
- Kreitzberg, C. W., 1966: "Structures within an occlusion as revealed by a mesoscale rawinsonde network," Paper presented at AGU-AMS Meeting, Washington, D. C, Apr. 19-22.
- Liu, B. Y. H., and K. T. Whitby, 1967: "Electrostatic aerosol sampler for light and electron microscopy," Rev. Sci. Instr., 38, 100-102.
- Wilson, J. W., and P. T. Jones III, 1968: Tracing Tropospheric Radioactive Debris by Isentropic Trajectories, Research Report 3, AEC Contract AT(11-1)-1199, Ill. State Water Survey.

APPENDIX A

THE RELATIONSHIP BETWEEN THE RADIOACTIVITY IN SURFACE AIR AND IN PRECIPITATION

Wayne E. Bradley

ABSTRACT

A study was conducted to determine the relationship between the gross beta radioactivity in surface air and in warm season precipitation. The precipitation was collected with several networks of rain sampling stations, many of which were capable of collecting a series of samples through a storm. The 24-hour air samples used were collected by the U. S. Public Health Service.

Regression analyses were made relating the average 24-hour air activity (C_a , pc m^{-3}) to the maximum, minimum, and mean precipitation activities (C_w , pc l^{-1}) of rains occurring during the 24 hours. The analyses were made for the individual stations and the entire networks on a yearly and 4-year basis. The station mean regression equation is $C_w = 550 C_a^{0.743}$ with a correlation coefficient of 0.602. A similar expression was determined for the deposition (d , pc m^{-2}) of $d/C_a = 490 P^{0.974}$, where P is the depth of precipitation in mm.

The C_w/C_a ratio was found to be 312 in Miami, Florida, 671 in Indianapolis, Indiana, and 1610 in Seattle, Washington. This variation appears to be dependent on the type of precipitation.

ACKNOWLEDGMENTS

The author is greatly indebted to Mr. F. A. Huff for reviewing the manuscript, and for the precipitation radioactivity data, the collection and analysis of which he diligently supervised. Appreciation is expressed to Dr. J. C. Neill for aiding in the statistical analysis of the data and to Mr. G. E. Stout under whose general direction this research was conducted.

INTRODUCTION

During the years 1962-1965 an extensive investigation was conducted of the rainout of radioactivity in east central Illinois (Huff and Stout, 1964; Huff and Bradley, 1965). The research was concerned primarily with the areal and time distribution of the rainout of gross beta radioactivity in spring and summer precipitation. Within the 4-year period, 10 different sampling networks were used at various times, the networks ranging in size from 26 to 15,540 km². With the exception of a dozen winter samples in 1962, the samples were taken in the March through September period.

An additional study has been conducted with the data to determine how well the gross beta activity in several thousand water samples correlated with 24-hour measurements of the activity in the air. These correlations reveal the feasibility of using air concentrations for predicting the concentration and deposition of radioactivity in precipitation.

The 24-hour gross beta air activity measurements used were from the Radiation Surveillance Network (R.S.N.) data published by the U. S. Public Health Service for the 1962-1965 period. All data were punched on cards and processed with an IBM 7094 computer.

Four sets of statistical analyses have been made. The first set compares the gross beta activity of the air to the activity of the maximum, minimum, and mean gross beta precipitation sample at each sampling station for consecutive water samples taken during a 24-hour period. The second set of analyses is similar to the first except it deals with the maximum, minimum, and mean of the entire network rather than individual stations. A third analysis determines the relationship between the gross beta deposition, the activity of the air, and the amount of precipitation. Finally, a comparison is made of the ratio of radioactivity in precipitation to that in the air for several different locations in the United States. The data provide a measure of the accuracy with which the deposition and concentration in rain over large areas can be determined with the existing R.S.N.

PRECIPITATION SAMPLING NETWORKS

The sampling networks were designed and used for several purposes and differed considerably, not only in size but also in sampler density and type of

collector. A brief description of the networks is given in table 1. Some of the sampling stations were equipped with only a total sampler capable of taking a single sample throughout a storm. Other stations had sequential samplers which took a series of samples during a storm. The remaining stations had both sequential and total samplers side by side. The "number of sequential samples" column in the table refers to the number of samples that the sequential collector was designed to collect, usually without attention. The sample depth column indicates the rainfall depth per sample. Samples from different types of sequential samplers are not entirely comparable because different depths of rainfall were sampled, as shown in table 1. Nevertheless, the frequency of network change and the great variability of the data did not permit separate analysis of the data from different networks and different size samplers. A more detailed description of the sampling networks is given by Huff (1963, 1965) and Huff and Bradley (1965).

TABLE 1

Precipitation sampling networks, warm seasons of 1962-1965

<u>Date</u>	<u>Number sequential samplers per network</u>	<u>Number total samplers per network</u>	<u>Network area (km²)</u>	<u>Number of sequential samples</u>	<u>Sequential sample volume (liters)</u>	<u>Sequential sample depth (mm)</u>
1962 Season	0	12	3,110	-	-	-
1962 Season	20	0	26	3	4	5.0
1962 Season	0	5	36	-	-	-
1962 Season	0	49	104	-	-	-
1963 April-May	16	16	15,500	12	2-3	1.2
1963 June-July	13	17	7,800	12	2-3	1.2
1963 August	5	10	1,040	12	2-3	1.2
1964 March-June	15	31	1,040	12	-	1.2
1964 June-August	4	4	104	12	2-3	1.2
1965 Season	5	0	104	unlimited	.7	.25
1962-1965, Lab	1	1	---	varied	varied	1.2

All of the air sample data in this research and some of the water samples used in the geographical variability portion of the analysis were taken by the R.S.N. sampling stations. The samplers were usually changed daily at about 0830 CST and represent 24-hour accumulations of radioactivity in precipitation or air. Network rainfall measurements taken after 0830 in the morning were compared with the filter removed the following morning.

PRECIPITATION ACTIVITY VS AIR ACTIVITY ANALYSIS

A regression analysis was performed to determine the relationship between the gross beta radioactivity in the surface air and in corresponding precipitation samples. The data were prepared in the following manner. For each network sampling station the 24-hour maximum, minimum, and mean precipitation beta activities were determined for the 24-hour period corresponding to the air sampling period. The mean station activity was computed from all the samples, the activity of each sample being weighted according to its volume. Regression analyses were then made comparing individually the station maximum, minimum, and mean water samples with the corresponding air sample on a yearly and 4-year basis. All analyses were performed with the common logarithms of the actual values. The results are as follows.

Figures 1, 2, and 3, respectively, show plots of the mean, maximum, and minimum beta concentration at network precipitation stations vs the corresponding daily air activities at the Springfield, Illinois, R.S.N. station for the 1962-1965 period. The exponential function curves fit reasonably well the maximum and mean precipitation data. The minimum data, however, appear as if they could be fitted better with a curved line. A closer examination of the minimum values reveals that the curving trend is due almost entirely to the 1963 data. The 1963 station minimum data, shown separately in figure 4, illustrate a pronounced seasonal change in the beta water/beta air ratio (C_w/C_a) during the March through September period. This trend is also present, though less pronounced, in the 1963 maximum and mean data. The reason for the seasonal change in C_w/C_a is not clear, but it may be related to rapid changes in the vertical distribution of radioactivity or in the particle size distribution following the cessation of atmospheric bomb tests at the end of 1962.

The amount of scatter in the data does not vary as much from year to year as might be expected. A possible explanation of this is because in 1962 and 1963,

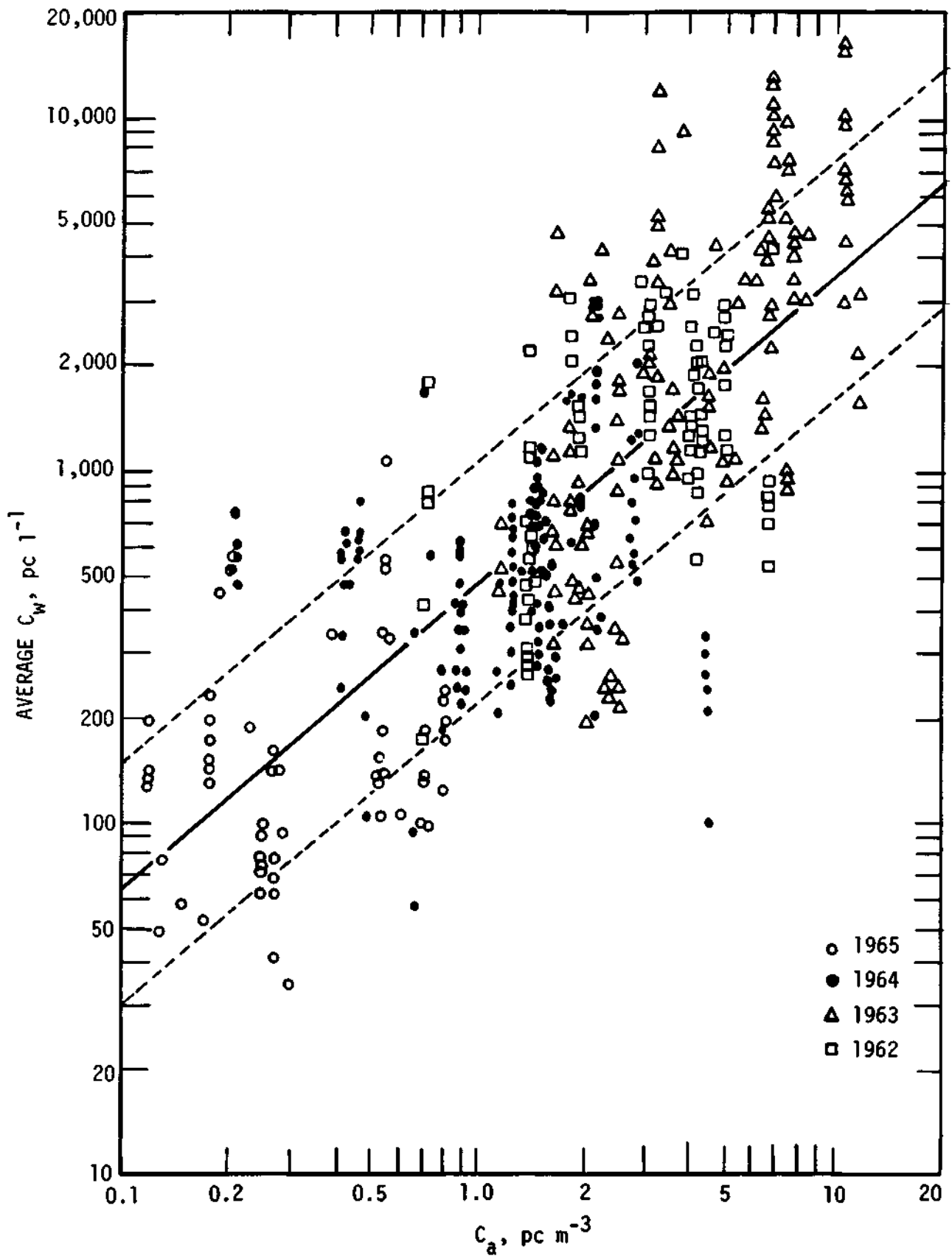

Figure 1. Relationship between the radioactivity in air and in average activity precipitation samples, spring and summer, 1962-1965.

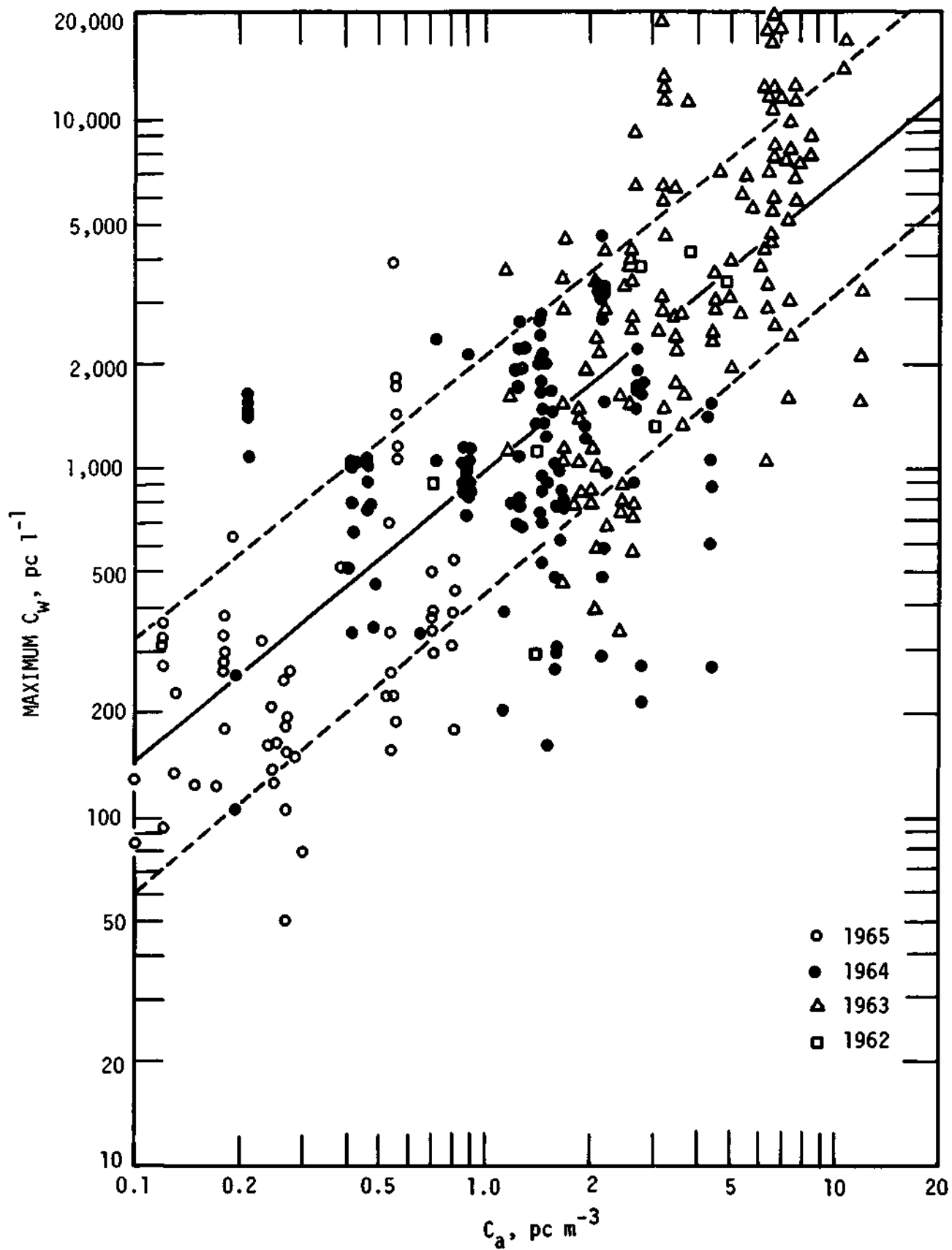

Figure 2. Relationship between the radioactivity in air and in maximum activity precipitation samples, spring and summer, 1962-1965.

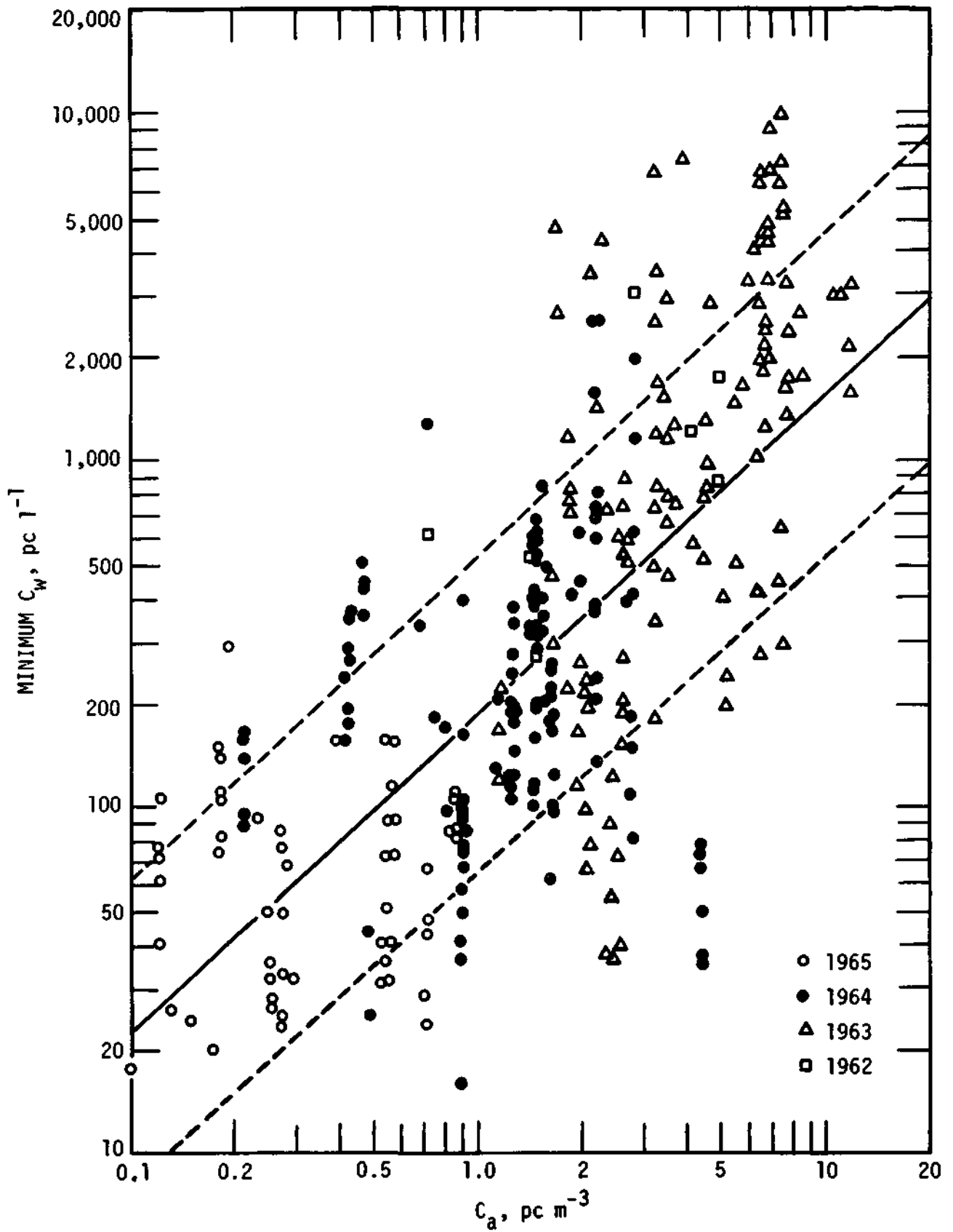

Figure 3. Relationship between the radioactivity in air and in minimum activity precipitation samples, spring and summer, 1962-1965.

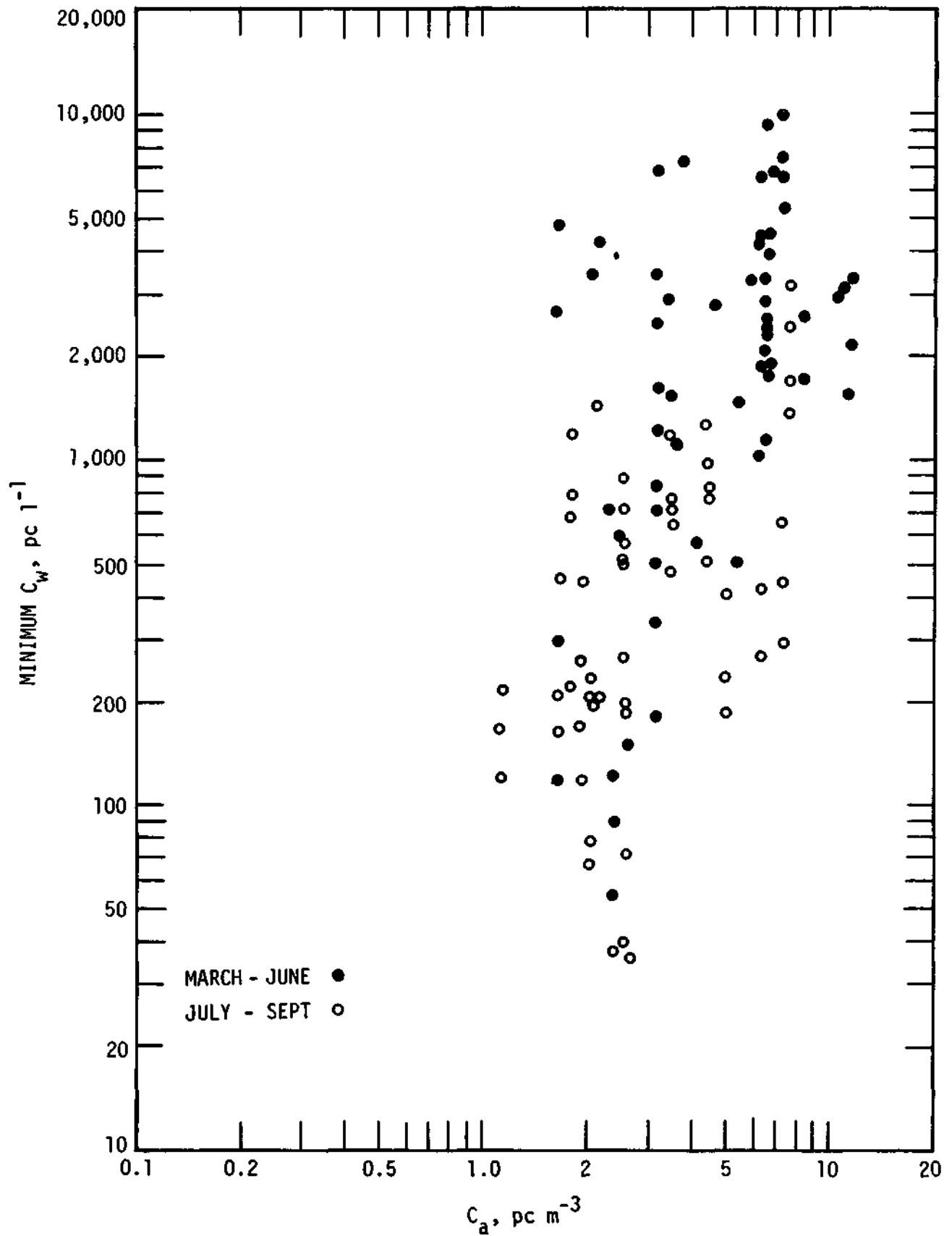

Figure 4. Relationship between the radioactivity in air and in minimum activity precipitation samples, spring and summer, 1963.

during and just after the bomb tests, there were great inhomogeneities in the distribution of bomb debris, but the sampling frequency (samples/cm precipitation) was less than in 1964 and especially 1965. In 1964 and 1965 the atmosphere was more evenly mixed, but with a higher sampling frequency, greater detail could be observed. These two factors apparently balanced out to make the standard error of estimate of the data from year to year approximately the same.

Regression analyses were also performed relating both the station and the network maximum, minimum, and mean Cw to the corresponding Ca. The network values represent the radioactivity extremes of the entire network and the volume-weighted mean of all the samples of all the stations for a given 24-hour period. The yearly and 4-year regression equations for the station and network analyses are given in tables 2 and 3, respectively, along with their correlation coefficients (r) and standard errors of estimate (s_e).

Tables 2 and 3 show that the exponent of Ca, i.e., the slope of the regression equations, varies considerably having extremes of 1.58 and 0.086. This variation in the slope results from the large amount of variability in the annual data, which is exemplified also by the low annual r's in tables 2 and 3. The slopes of the regression equations for the entire 1962-1965 period are less than 1, causing the average station Cw/Ca ratio to increase by a factor of nearly two as Ca decreased two decades.

In tables 2 and 3 the station yearly and 4-year maximum and minimum r's are usually greater than the corresponding network values. This is not surprising since the network values represent extremes in the station values. In contrast, the network mean usually has a slightly higher correlation coefficient than that for the station mean. The 4-year network maximum and mean Cw are approximately 58 percent dependent (r^2) upon Ca, while the minimum Cw is 44 percent dependent. The station maximum, minimum, and mean are 59, 48, and 36 percent dependent, respectively.

From table 2 the equation for estimating the mean station Cw for a given Ca using the 4-year data is $Cw = 550 Ca^{0.743}$. The standard error of estimate of Cw is $10^{\pm 0.445}$, i.e., 67 percent of the measurements fall within the limits $2.78 Cw > Cw > Cw/2.78$ with Cw estimated from the equation. The maximum and minimum regression equations are $Cw = 960 Ca^{0.842}$ and $Cw = 186 Ca^{0.931}$, respectively. The extremes for the maximum and minimums can be estimated with the use of two standard errors of estimate. Thus, 2.5 percent of the maximum Cw's exceeded $4147 Ca^{0.842}$ and 2.5 percent of the minimum Cw's were less than $32.4 Ca^{0.931}$. These extremes differ by more than two orders of magnitude.

TABLE 2

Station regression equations, standard errors of estimate,
and correlation coefficients

<u>Date</u>	<u>Type</u>	<u>Regression equation</u>	Standard error of estimate (s_e)		<u>Correlation coefficient (r)</u>
			<u>upper limit</u>	<u>lower limit</u>	
1962	Max.	$Cw = 660 Ca^{.969}$	2.15 Cw	Cw/2.15	.684
1962	Min.	$Cw = 458 Ca^{.768}$	1.88 Cw	Cw/1.88	.670
1962	Mean	$Cw = 800 Ca^{.528}$	1.86 Cw	Cw/1.86	.444
1963	Max.	$Cw = 775 Ca^{1.13}$	2.11 Cw	Cw/2.11	.642
1963	Min.	$Cw = 93.5 Ca^{1.58}$	2.85 Cw	Cw/2.85	.641
1963	Mean	$Cw = 317 Ca^{1.30}$	2.22 Cw	Cw/2.22	.669
1964	Max.	$Cw = 1050 Ca^{.147}$	1.84 Cw	Cw/1.84	.162
1964	Min.	$Cw = 210 Ca^{.163}$	2.54 Cw	Cw/2.54	.118
1964	Mean	$Cw = 520 Ca^{.086}$	1.85 Cw	Cw/1.85	.007
1965	Max,	$Cw = 575 Ca^{.590}$	2.07 Cw	Cw/2.07	.473
1965	Min.	$Cw = 67.8 Ca^{.278}$	2.27 Cw	Cw/2.27	.219
1965	Mean	$Cw = 258 Ca^{.421}$	2.12 Cw	Cw/2.12	.355
* * * * *					
1962	Max.	$Cw = 960 Ca^{.842}$	2.16 Cw	Cw/2.16	.765
to	Min.	$Cw = 186 Ca^{.931}$	2.88 Cw	Cw/2.88	.692
1965	Mean	$Cw = 550 Ca^{.743}$	2.78 Cw	Cw/2.78	.602

TABLE 3

Network regression equations, standard errors of estimate,
and correlation coefficients

<u>Date</u>	<u>Type</u>	<u>Regression equation</u>	Standard error of estimate (s_e)		<u>Correlation coefficient (r)</u>
			<u>upper limit</u>	<u>lower limit</u>	
1962	Max.	$C_w = 1480 C_a^{.403}$	1.48 Cw	Cw/1.48	.553
1962	Min.	$C_w = 470 C_a^{.592}$	2.00 Cw	Cw/2.00	.481
1962	Mean	$C_w = 930 C_a^{.443}$	1.60 Cw	Cw/1.60	.517
1963	Max.	$C_w = 1815 C_a^{.714}$	2.01 Cw	Cw/2.01	.567
1963	Min.	$C_w = 85 C_a^{1.24}$	3.18 Cw	Cw/3.18	.591
1963	Mean	$C_w = 480 C_a^{.956}$	2.11 Cw	Cw/2.11	.657
1964	Max.	$C_w = 1310 C_a^{.241}$	1.83 Cw	Cw/1.83	.273
1964	Min,	*	*	*	*
1964	Mean	*	*	*	*
1965	Max,	$C_w = 835 C_a^{.556}$	1.84 Cw	Cw/1.84	.565
1965	Min.	$C_w = 39 C_a^{141}$	2.23 Cw	Cw/2.23	.131
1965	Mean	$C_w = 195 C_a^{.292}$	1.75 Cw	Cw/1.75	.367
* * * * *					
1962	Max.	$C_w = 1310 C_a^{.765}$	1.94 Cw	Cw/1.94	.764
to	Mm.	$C_w = 142 C_a^{.946}$	3.02 Cw	Cw/3.02	.659
1965	Mean	$C_w = 500 C_a^{.828}$	2.06 Cw	Cw/2.06	.763

* Correlation coefficient too low for computer program

For the type of observations studied here the variability of the slopes of the yearly regression equations as well as the variability of r and s_e demonstrate that the relationship between C_a and C_w is somewhat tenuous, and that long-term averages are necessary to establish the relationship. Daily measurements of C_a may be used to estimate the mean daily C_w within only a factor of 2 or 3.

DEPOSITION VS AIR CONCENTRATION AND RAINFALL

Some applications of precipitation radioactivity data are concerned more with the total deposition of radioactivity than with the concentrations of samples taken through a storm. An analysis was therefore made relating 24-hour station deposition d ($\mu\text{c m}^{-2}$) to C_a and depth of rainfall P (mm). As previously mentioned, some of the Illinois Water Survey network sampling stations collected total storm samples. For these stations $d = C_w \times P$. The depth, P , was determined either from a raingauge accompanying the sampler or by calculating P from the sample volume and sampler area. At stations where a fractional sampler was used the total 24-hour deposition was computer-calculated by summing the deposition from the individual samples.

Before correlating d with P , d was normalized by dividing each d by the corresponding C_a . A regression of the ratio d/C_a vs P was then made. The results of the analysis are presented in table 4, giving the annual and 4-year regression equations, along with their standard errors of estimate and correlation coefficients. The regression equation for the 4-year period, $d/C_a = 490 P^{0.974}$ is also plotted in figure 5. Sixty-seven percent of the given P values of d/C_a fall within the limits $2.87 d/C_a > d/C_a > d/2.87 C_a$. The slope measuring 0.974, being nearly equal to one, indicates a direct relationship between the deposition and amount of rainfall. From this it follows that C_w is nearly independent of P .

The deposition discussed up to this point is entirely from precipitation and has not included dry deposition. The curved line in figure 5 is total deposition data taken in Michigan during periods of 1962 and 1963 by Pelletier et al. (1965) and includes both the wet and dry deposition falling into the collector. This Michigan data represent monthly averages from 9 air sampling and 10 precipitation sampling stations. As P approaches zero, the ratio d/C_a approaches $\sim 6 \times 10^3$, which can be considered the monthly dry deposition. If

the dry deposition is subtracted from the entire Michigan curve, the result is a wet deposition curve similar to the Illinois curve. Since the Midwest usually gets at least 50-100 mm of precipitation per month during the warmer season, it can be determined from figure 5 that the monthly dry deposition is about 15 percent of the total deposition. This is in good agreement with the 14 percent determined by Small (1960).

In Illinois the ratio C_w/C_a is nearly independent of the amount of rainfall. If the ratio d/C_a in figure 5 is divided by a given P , the result is the ratio C_w/C_a for that P . It may thus be shown that as P increases from 1 mm to 50 mm, C_w/C_a decreases only from 490 to 430. Yet in an analysis of the R.S.N. data for Indianapolis, Seattle, and Miami, it was found that the ratio C_w/C_a usually decreases by at least a factor of 2 as P increases from 1 to 50 mm. The Indianapolis, Indiana, data are given in figure 5.

TABLE 4

Station regression equations, standard errors of estimate, and correlation coefficients for d/C_a

Date	Regression equation	Standard error of estimate (s_e)		Correlation coefficient (r)
		upper limit	lower limit	
1962	$d/C_a = 850 P^{-.780}$	1.87 d/C_a	$d/1.87 Ca$.821
1963	$d/C_a = 575 P^{-.967}$	2.86 d/C_a	$d/2.86 Ca$.875
1964	$d/C_a = 323 P^{1.14}$	3.32, d/C_a	$d/3.32 Ca$.797
1965	$d/C_a = 725 P^{.731}$	2.19 d/C_a	$d/2.19 Ca$.745
1962-1965	$d/C_a = 490 P^{-.974}$	2.87 d/C_a	$d/2.87 Ca$.847

The difference between the Illinois Water Survey and R.S.N. data may be explained by considering the effect of dry fallout on the C_w/C_a ratio. The R.S.N. samplers are not washed prior to precipitation whereas the Illinois samplers usually were. The dry deposition in the R.S.N. samples increases the C_w/C_a ratio for low rainfall samples but has a negligible effect on the larger rains. The

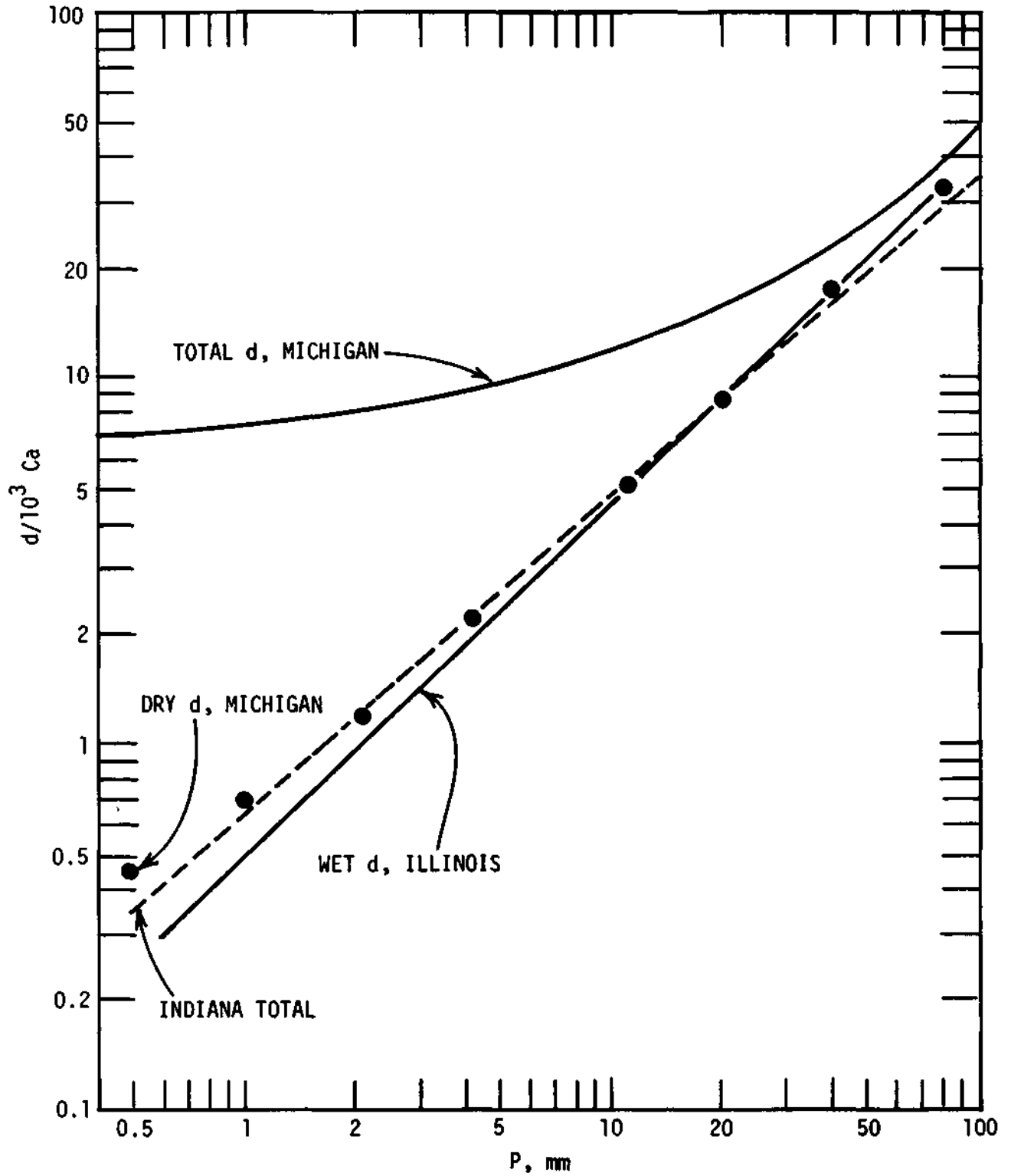

Figure 5. Relationship between radioactive deposition, air concentration, and precipitation depth.

d/Ca ratio for a given P is much lower for the R.S.N. data than for the Michigan data because the Michigan data have dry d for the entire month in the data while the R.S.N. data have only the dry fallout deposited since the previous rain.

GEOGRAPHICAL VARIABILITY OF Cw/Ca

A study was made to determine how the Cw/Ca ratio in the Midwest compares with similar data from other parts of the country. Twenty-four hour precipitation samples from the R.S.N. were correlated with their concurrent air samples for several different locations. Only data from April through August were used in order to keep the sampling periods compatible with the Illinois Water Survey sampling time. The data for any entire month were discarded if 20 percent or more of the water samples had levels of radioactivity too low to measure. The year 1965 was excluded because most of the precipitation activities were below the sensitivity of the R.S.N. counting procedures.

A tabulation of annual and 3-year Cw/Ca ratios for five different cities is given in table 5. Of the 3-year averages, the Cw/Ca ratio at Indianapolis of 671 is over twice as large as the 312 at Miami, and the Seattle and Anchorage ratios of 1610 and 1600 are over twice as large as the ratio at Indianapolis. Fairbanks falls between Seattle and Anchorage with a 3-year ratio of 1100. These ratios are in general agreement with values found in other parts of the world. For an equivalent period of April through August of 1957, Small (1960) found the average Cw/Ca ratio in Kjeller, Norway, to be 1090, 894, and 800 for the years 1957, 1958, and 1959, respectively. The 1957 value of 1090 in Norway contrasts with a 1957 value of 333 for a 10-station average in Germany from July to December (Hinzpeter, 1958). The Cw/Ca ratios from various parts of the U. S. and Europe agree remarkably well considering the great variability found in individual samples throughout a storm, and the numerous factors influencing the precipitation activity.

The geographic variability of Cw/Ca may be caused by either, or both, of two factors. If, for example, Ca increases more rapidly with height over Seattle than over Indianapolis, the Seattle surface measurements would be less representative of the air at cloud base level and would tend to increase the apparent Cw/Ca ratio. An evaluation of this explanation is difficult because of the lack of data pertaining to the geological variation of Ca with height, and the level from which a cloud ingests most of its air.

TABLE 5

Cw/Ca ratios for several locations

<u>Station</u>	<u>Year</u>			
	<u>1962</u>	<u>1963</u>	<u>1964</u>	<u>1962-1964</u>
Miami, Florida	293	276	486	312
Indianapolis, Indiana	576	711	709	671
Seattle, Washington	1980	1260	1830	1610
Anchorage, Alaska	1310	2050	1010	1600
Fairbanks, Alaska	602	1220	1120	1100

A second explanation is that the storm scavenging efficiency varies from one location to another because different types of precipitation mechanisms dominate in different areas. The concentration k of a material in precipitation ($\mu\text{c cm}^{-3}$ STP) as discussed by Junge (1963) is given by $k = Ca \times e/L$ where Ca is the concentration in the air ($\mu\text{c m}^{-3}$ STP), e is the rainout efficiency, and L the liquid water content of the cloud (g m^{-3} STP). This equation ignores rainout that may exist beneath the cloud. The geographical variations in Cw/Ca , or in k/Ca , (Cw and k differ only in units) may be explained by considering the effect of variations in L . The measurements of L of several investigators as summarized by Byers (1965) are not adequate to compare quantitatively the average L expected in the regions considered, but qualitative comparisons can be made. The average L in the humid subtropics at Miami is greater than in Illinois. Likewise, Seattle, with its high percentage of stratified precipitation in spring and summer should have a lower L than Illinois, which has mostly convective precipitation during the same period. A variation of the average L as discussed above would cause k to vary in the observed direction, that is, to be higher in Seattle and lower in Miami.

The predominance of precipitation from low pressure systems in the Seattle region also indicates that the cloud droplets have a longer lifetime to scavenge radioactive particulates by Brownian motion in the less than 0.1 micron diameter size range. This would tend to maximize e , although e cannot exceed 1 if the continuity of the parcel of air is retained.

In an actual cloud, however, the parcel is not maintained because there is considerable mixing with environmental air as is exhibited by the observation that measured L is usually several times lower than L estimated by adiabatic

parcel ascent (Byers, 1965). This means that while condensation is taking place the water vapor has access to entrained air and its associated radioactive particulates, thus violating the constant parcel concept, but giving e an effective limit greater than 1.

Values of e for estimates of L were determined from the data taken by the Water Survey. The station mean regression equation yields $e/L = 0.5$. For the maximum data, $e/L = 1$, and for the minimum, $e/L = 0.18$. Thus, if we assume a typical value of $L = 2$, then $e = 2, 0.54$, and 1 for the station maximum, minimum, and mean, respectively. Evaporation and washout beneath the cloud base will tend to increase e/L . Unfortunately, L is too varied to permit accurate estimates of e , but the estimates of values close to 1 seem reasonable.

DISCUSSION

The variability in the C_w/C_a ratio at a sampling station may be attributed to several factors. The 24-hour air sample is not necessarily representative of the radioactivity within the precipitating portion of cloud, and the scavenging efficiency may change with time in the cloud because of the complexities of the precipitation process. Both of these factors are difficult to evaluate but will be discussed.

The R.S.N. provides C_a information just once each 24 hours, and does not define the small scale horizontal variations occurring in C_a . In addition there are inhomogeneities within the cloud resulting from portions of the air being cleaned by the rainout of radioactive material. The C_a in other areas may at the same time be enhanced from the evaporation of cloud droplets which have previously scavenged radioactive material.

There is also a bias caused by the vertical gradient of radioactivity, making the surface C_a measurement unrepresentative of C_a at the rain formation level. This problem may be increased by the presence of stratospheric extrusions as described by Danielsen (1964) and subsynoptic vertical motion as studied by Feteris (1968). Penetration of the tropopause may also result in unusually high C_w measurements, as suggested by Kruger and Hosier (1963). These factors may be largely offset by the fact that most of the moisture laden air originates within the mixing level, but nevertheless, entrainment of air from higher elevations will increase C_a .

A comparison was made of Ca at Springfield, Illinois, with simultaneous measurements of Ca at Indianapolis, Indiana, approximately 310 km to the east. These data indicate the variation in the 24-hour samples' over distances of 300 km. For the period of 1963-1965, 759 observation comparisons were possible. The correlation coefficient for the two stations was 0.959. If Ca at Springfield is used to predict Ca in Indianapolis, 67 percent of the predictions fall within the limits of 144-70 percent of the measured value.

As previously mentioned, the Cw/Ca ratio fluctuates "also because of variations in the particulate scavenging efficiency of the cloud resulting from changes in the degree of condensation or coalescence as well as the lifetime of the cloud droplets. Partial evaporation of the cloud and raindrops both within and beneath the cloud increases the concentration. Finally, radioactive material may be washed out beneath the cloud base.

SUMMARY

A statistical analysis was conducted to determine the relationship between the gross beta radioactivity in air and the activity in concurrent precipitation collected over several sampling networks. For a single season the correlation coefficients are very low, but are somewhat higher for the entire 1962-1965 period. Regression equations were determined for the station and network maximum, minimum, and mean 24-hour precipitation radioactivity samples. The regression equation for the station mean for the 1962-1965 period is $Cw = 550 Ca^{0.743}$ with a correlation coefficient of 0.60.

A similar analysis was conducted relating the total 24-hour station" deposition to the activity of the air and depth of precipitation. The regression equation is $d/Ca = 490 P^{0.974}$ with a correlation coefficient of 0.76.

The equations given may be used to obtain a rough approximation of the concentration of radioactivity in precipitation and the resulting deposition over large areas from the R.S.N. air samples. The standard errors of estimate, however, are large.

The equations given apply to precipitation in the Midwest. In other regions of the country, the predominant precipitation mechanisms are somewhat different. The Cw/Ca ratio in Miami, Florida, was found to be only half as large as in Illinois, whereas in Seattle, Washington, the ratio was twice as large as in Illinois.

REFERENCES

- Byers, Horace R. , 1965: Elements of Cloud Physics, University of Chicago Press, Chicago, 144.
- Danielsen, E. F., 1964: Report on Project Springfield, Defense Atomic Support Agency-1517, 143.
- Feteris, Pieter J., 1968: Statistical Analysis of Sub-Synoptic Meteorological Patterns, Final Report, NSF Contract GA-1321.
- Hinzpeter, Max, 1958: The Influence of Meteorological Parameters on the Propagation of Radioactive Fission Products in the Biosphere, Proceedings of the 2nd International Conference on the Peaceful Uses of Atomic Energy at Geneva, Vol. 18, 284-290.
- Huff, F. A., 1963: Study of Rainout of Radioactivity in Illinois, First Progress Report, AEC Contract AT(11-1)-1199.
- Huff, F. A., 1965: Study of Rainout of Radioactivity in Illinois, Third Progress Report, AEC Contract AT(11-1)-1199.
- Huff, F. A., and W. E. Bradley, 1965: Study of Rainout of Radioactivity in Illinois, Fourth Progress Report, AEC Contract AT(11-1)-1199.
- Huff, F. A., and G. E. Stout, 1964: "Distribution of Radioactive Rainout in Convective Rainfall," J. Appl. Meteorol. , 3, 707-717.
- Junge, Christian E., 1963: Air Chemistry and Radioactivity, Academic Press, New York, 291.
- Kruger, P., and C. L. Hosier, 1963: " Sr^{90} Concentration in Precipitation from Convective Showers," J. Appl. Meteorol., 2, 379-389.
- Pelletier, Charles A., G. Hoyt Whipple, and Harold L. Wedlick, 1965: Radioactive Fallout from Nuclear Weapons Tests, U. S. Atomic Energy Commission.
- Small, S. M., 1960. "Wet and Dry Deposition of Fallout Materials at Kjeller," Tellus, 12, 308-314.

APPENDIX B

THE VERTICAL DISTRIBUTION OF TRITIUM IN WATER VAPOR IN THE LOWER TROPOSPHERE

Wayne E. Bradley

ABSTRACT

A series of aircraft soundings was made over central Illinois during the summers of 1966 and 1967 to measure the vertical distribution of tritium in water vapor to an altitude of 5 km. Three types of tritium distributions were found. The type I soundings showed a generally increasing tritium concentration with increasing height. Type II soundings were characterized by a constant tritium concentration with increasing altitude. On type III soundings the tritium concentration gradually decreased to approximately 2.1 km and then abruptly increased. The soundings are discussed in terms of the origin of the air masses, evapotranspiration, and the water vapor mixing ratio.

ACKNOWLEDGMENTS

The author is grateful to G. E. Stout for initiating and continually supporting the research. I wish to thank J. W. Wilson for assistance on a portion of the sampling flights, N. G. Towery for his trajectory analyses, and F. A. Huff for reviewing the manuscript.

Special thanks are given to L. B. Lundgren and Dr. E. Eriksson of the International Meteorological Institute in Stockholm, Sweden, for loan of equipment and for analysis of the 1966 tritium samples, and to H. G. Ostlund of the Institute of Marine Sciences, University of Miami for helpful discussions of sampling techniques and the analysis of several samples.

INTRODUCTION

Tritium, a heavy isotope of hydrogen, has been relatively abundant in the atmosphere since the advent of thermonuclear testing in 1954. Numerous measurements have been made of its worldwide distribution in precipitation, and surface and ground water, along with a lesser number of observations in atmospheric moisture. Most of these measurements were associated with the use of tritium as a label enabling hydrologists, meteorologists, and oceanographers to follow the movement of water through the hydrologic cycle or some portion thereof (Eriksson, 1958, Bolin, 1958; Giletti et al. , 1958). Significant knowledge has been gained despite the complications which arise from fractionation during evaporation and condensation.

During the summers of 1966 and 1967 an investigation was made in central Illinois of the distribution of tritium in water vapor in the lower troposphere. Studies were conducted of the vertical distribution of tritium, its variation with time, and the meteorological factors influencing the distribution. The tritium soundings were compared with their associated temperature and humidity soundings from the U. S. Weather Bureau in Peoria, Illinois, 120 km from the soundings, and with the origin of the air masses sampled.

SAMPLING PROCEDURE

The tritium sampling altitudes were chosen prior to each sounding by examining the U. S. Weather Bureau rawinsonde data from Peoria, Illinois. Sampling altitudes were chosen to avoid measurements across temperature inversions or moisture discontinuities whenever possible. Calculations were made to determine the sampling time necessary to collect 25 ml of water, but, occasionally, extremely dry air aloft necessitated the collection of a smaller sample.

During 1966 the samples were collected while the aircraft ascended through the sampling layer at a constant rate. In 1967 the sampling was performed at a constant altitude to facilitate simultaneous radon measurements which will be reported in a future paper. The sampling flights were begun at approximately 1000 CST and were compared with the radiosonde data from Peoria, Illinois, taken at 0600 CST.

Details of the tritium sampling system have been given by Bradley and Feteris (1966), but a brief description follows. The water vapor samples were collected for tritium analysis with an adsorption system carried aloft in a Twin-Beech aircraft. The vapor was adsorbed in traps containing 400-500 grams of Lindy molecular sieve No. 4 AXW. Air was sampled through a forward facing nozzle and drawn through the sieve traps with a positive displacement blower at a sampling rate of approximately $0.5 \text{ m}^3 \text{ min}^{-1}$. After the sampling process the water was removed from the traps by subjecting them to a temperature of 560°C and vacuum of 10^{-4} mm mercury.

The released water vapor was collected in a cold trap and later analyzed for tritium. Although the bulk of the water was removed from the traps in the first 2 or 3 hours of oven warmup, the traps were baked an additional 7 to 20 hours at maximum temperature to minimize the volume of water remaining in the trap. The normal sample size of ~ 25 ml water was more than the several ml needed for analysis, but it was collected to minimize the influence on the next sample of the ~ 0.3 ml of water that remained in the sieve after baking.

Tritium analysis of the 1966 samples was performed by the International Meteorological Institute in Stockholm, Sweden, under contract with the AEC. All the 1967 tritium data were analyzed by Isotopes, Inc., of Westwood, New Jersey, under contract with the Water Survey, with the exception of a few that were analyzed by the Institute of Marine Science at the University of Miami. Several tests conducted concerning the accuracy of the sampling systems are described in Appendix i.

DATA ANALYSIS

Tritium Soundings

The concentration of tritium (T) in the lower troposphere varies considerably according to the season and the associated meteorological conditions, and from year to year, as can be seen by examining the 13 tritium soundings in Appendix ii. It is therefore useful in comparing the soundings with each other to normalize T. This was done by plotting T on a log scale and shifting horizontally the T scale or x-axis until the lowest altitude tritium measurement of each sounding was superimposed upon the others. In this manner, soundings of differing concentrations were compared with respect to their relative variation with altitude, and three basic types of tritium soundings were observed.

The tritium concentration of the type I soundings showed a general increasing trend from the surface to the top of the soundings. The type II soundings were characterized by a constant T with increasing altitude. On the type III soundings T initially decreased in the first couple km and then abruptly increased.

The primary factors expected to influence the concentration of tritium at a given elevation are (1) the stratospheric concentration and degree of stratospheric-tropospheric exchange, (2) the origin of the air mass with respect to the stratospheric and continental sources and the oceanic sink, (3) the degree of vertical exchange, (4) the water vapor mixing ratio (MR) of the environmental air, and (5) the amount of evapotranspiration. Since most of these factors are controlled by atmospheric circulations, the T soundings may be best explained by considering the associated weather along with the tritium sources and sinks.

Type I soundings shown in figure 1 are characterized by a general increase in T with increasing altitude. The greatest change in T with altitude is concurrent with an abrupt decrease in the water vapor mixing ratio which, in three out of four cases, resulted from a subsidence inversion (see Appendix ii). The sounding of 21 April 1966 does not appear to have a drying trend at the level of the increase in tritium, but the tritium sounding was taken about noon, or midway between the 0600 and 1800 CST sounding, and it is suspected that the strong subsidence inversion that was present at 1 km in the evening was near the 2.7-km level during the tritium sounding. On all four soundings the air trajectories at all sampling levels were out of the west or north continental United States or Canada.

The sounding of 5 July 1967 bears a question mark on the unusually high value of 29 80 TU. There does not appear to be any associated variation in the moisture data to explain the unusually high value. Its value is being rechecked.

The increase in T associated with the drying aloft is the result of air at those elevations having been more recently mixed with air of stratospheric origin than the air in the lower layers. In contrast the lower level air has had more recent contact with Pacific Ocean moisture at 15-20 TU (Houtermans, 1965). The most abrupt change in the T gradient thus occurs at the interface between the two layers.

On the type II soundings shown in figure 2 the tritium concentration is relatively constant with increasing altitude. As with the type I soundings, the air trajectories are also out of the west or north. During the 15 April 1966

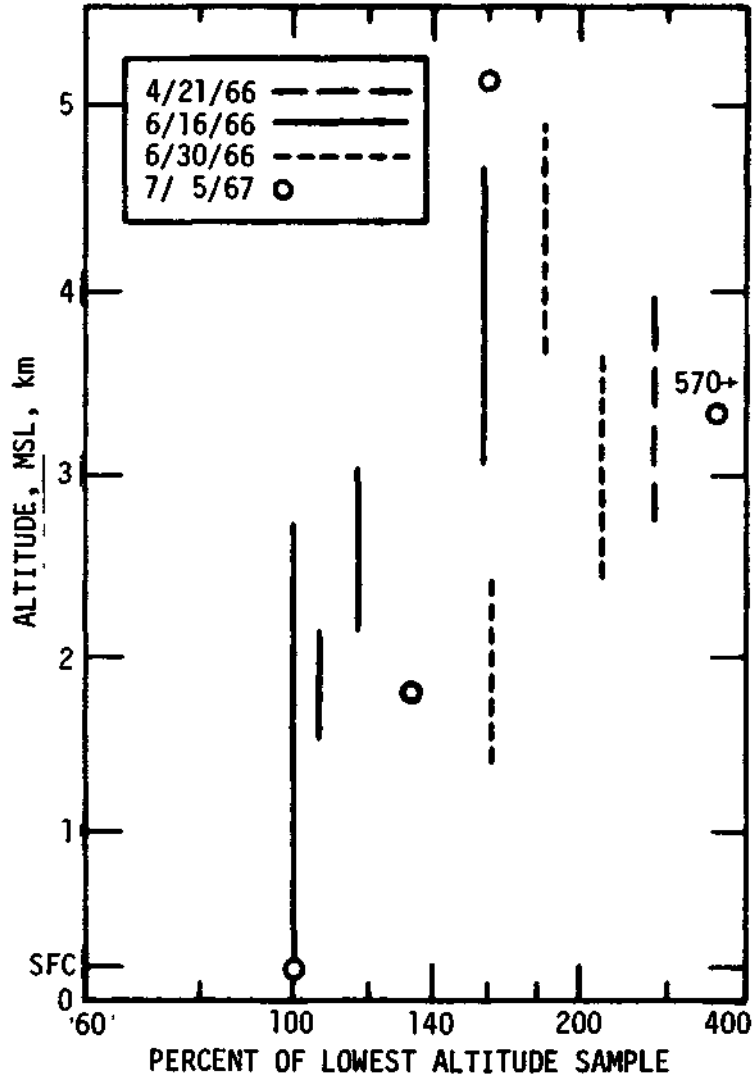

Figure 1. Type I normalized tritium soundings over central Illinois.

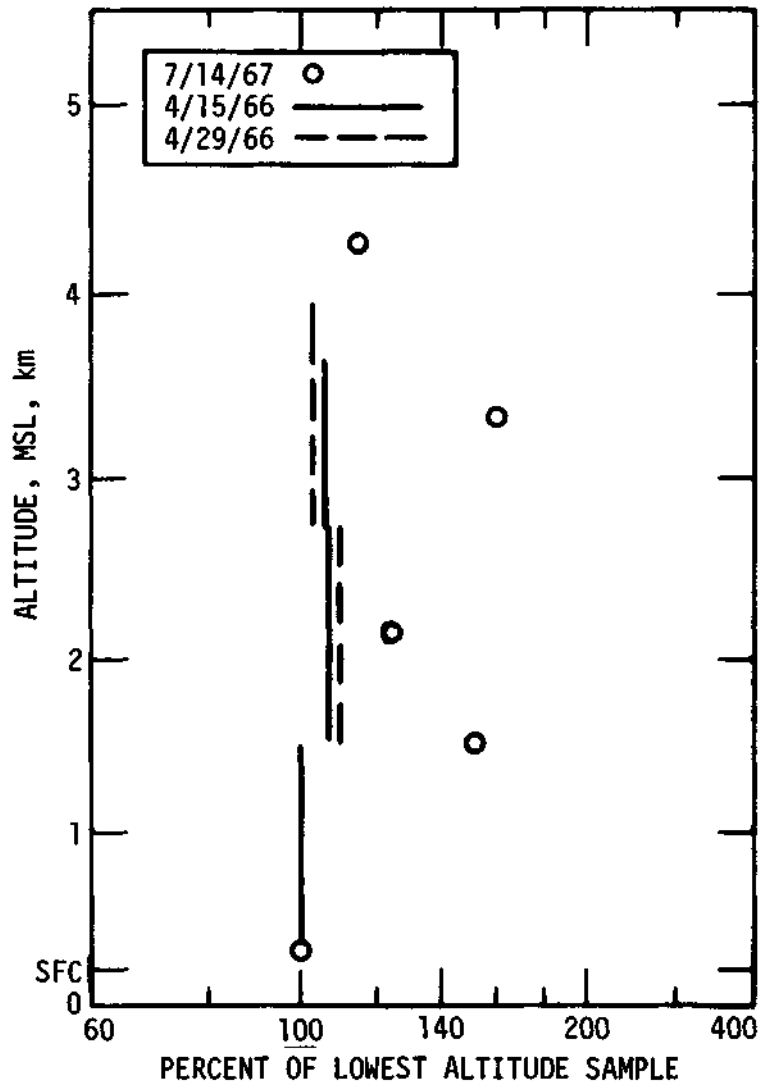

Figure 2. Type II normalized tritium soundings over central Illinois.

flight the aircraft was completely surrounded by towering cumulus indicating good vertical mixing resulting in a constant T with height. On the 29 April 1966 sounding T appeared to be constant because of the moist layer associated with the highest altitude sample. For the sounding of 14 July 1968 an explanation of the constant T is not apparent in the moisture or temperature data.

The type III soundings shown in figure 3 are characterized by T gradually decreasing with altitude from the surface to the 2,400-3,300 m level. The decrease is relatively small, varying from 12-24 percent of the surface value, and is followed by an abrupt increase in T of about a factor of two. The sounding of 26 July 1966 included in this group does not have measurements above 2,400 m, but does have the decreasing T, or tritium inversion, in the lower layers.

On the soundings of 23 June 1966 and 11 July 1966 the abrupt increase was directly associated with the top of the moist layer as in the type I sounding, but the connection was not as direct for the other three soundings. The most interesting difference between the type III and type I soundings is the decrease in T in the lower layers on the type III soundings. This tritium inversion is linked to trajectories of the air in the lower moist layer as follows.

The first four type III soundings were taken during June and July of 1966. During each of these soundings the air trajectories at the 850-mb level, and sometimes at the 700 mb level, were from the Gulf of Mexico. The oceans and Gulf are effective sinks for tritium so the concentration in Gulf air is several times lower than it is in the Midwest as is exhibited by a sounding taken on the Gulf at 1030 CST, 20 July 1967 southwest of New Orleans, Louisiana, shown in figure 4. At the time of this sounding the area was under the influence of a very weak pressure gradient. Numerous showers and thunderstorms were developing just inland from the coast. At 0600 CST the winds in the area were light and out of the north, but from the concentration of tritium in the sounding, it would appear that the air had had a recent trajectory over the Gulf.

An air mass leaving the Gulf would thus be expected to have a relatively low T, but, as the air mass moves from the Gulf into the Midwest, it not only loses tritium to the surface through precipitation but also regains much of it back through evapotranspiration. The tritium inversion exhibited in the type III soundings, i.e., the decrease of T in the first 3000 m or so, is apparently the result of the evapotranspiration of water vapor into the lowest layers of the atmosphere. However, in order to create an inversion the vapor must return to the atmosphere at a concentration higher than the concentration in ambient

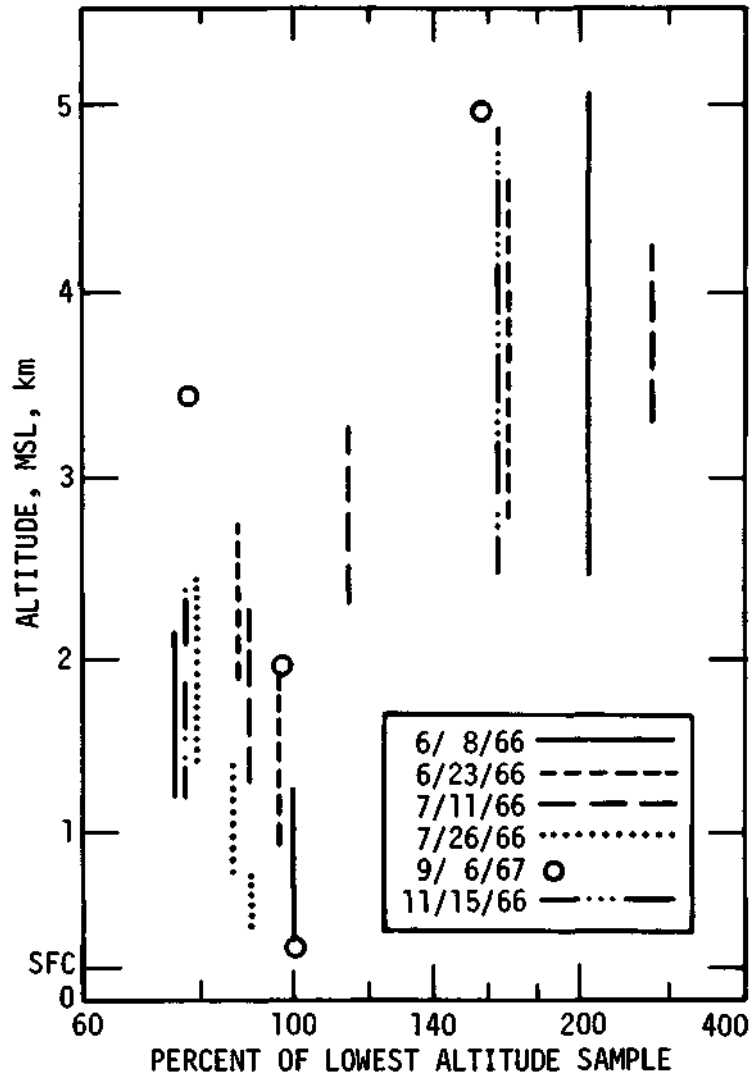

Figure 3. Type III normalized tritium soundings over central Illinois.

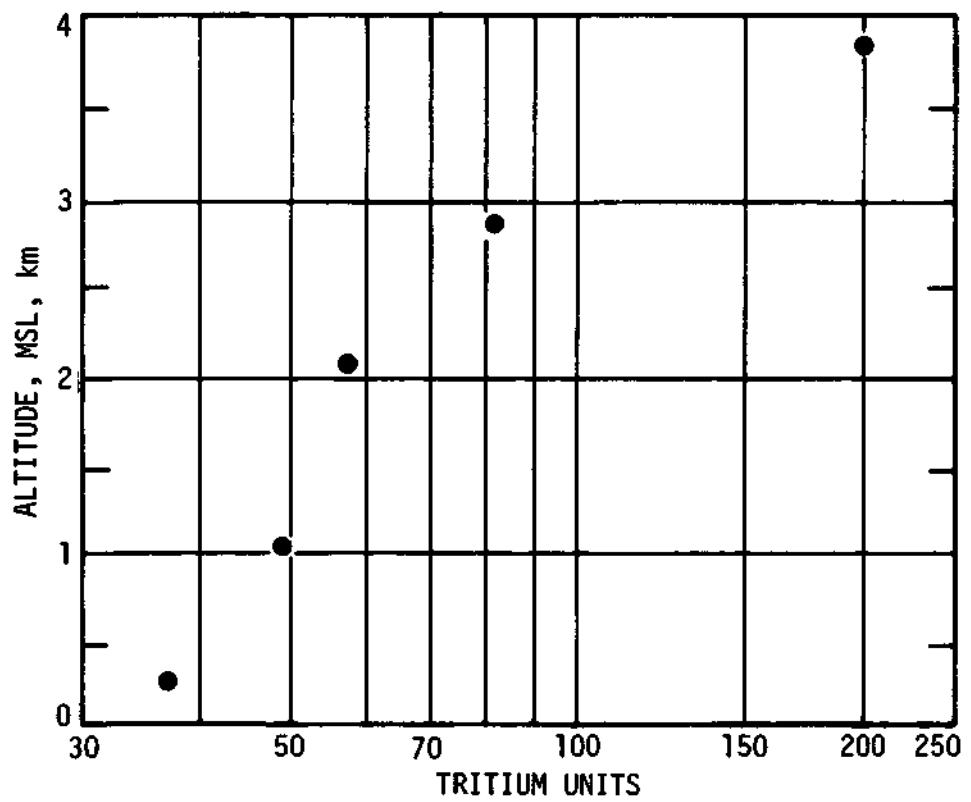

Figure 4. Tritium sounding on the Gulf of Mexico, 20 July 1967.

atmospheric moisture. The movement of water through the soil and plants is primarily by capillary motion so little mixing or fractionation is likely during evapotranspiration. To create the inversion the soil moisture must contain a higher T than the ambient air.

There are several processes by which this could occur. Convective rain clouds which penetrate the upper troposphere or the stratosphere will entrain environmental air with a T considerably higher than that at lower levels between rains. However, the amount of moisture is extremely small at these levels so that the available tritium is also very small. A second explanation is that precipitation occurring earlier in the spring with higher T's is stored in soil and is evapotranspired later in the summer when transpiration is great and T in atmospheric moisture has decreased. A third mechanism is described by Bolin (1958) who examined the exchange processes between the atmosphere and the soil and predicted that soil moisture would have a T 70 percent higher than atmospheric moisture because of fractionation. It is likely that all three of the above mechanisms contribute in some degree to the high concentration in the soil and evapotranspired water.

The presence of a tritium inversion several times more intense than the ones discussed here was predicted by Smith (1966) for continental air. He attributed the inversion to intense evapotranspiration but did not discuss the necessity of the transpired moisture being of a higher concentration than the ambient moisture to create the inversion.

There were two type III soundings on 6 September 1967 and 15 November 1966 which were not in Gulf air. Air trajectories were out of the north and west, respectively. Perhaps in the fall, after the stratospheric-tropospheric exchange has undergone its annual decrease, the atmospheric input from the surface through evapotranspiration becomes relatively more important in comparison with the input from aloft. As the surface becomes a more dominant source of tritium, the inversion can appear regardless of the source of the air mass.

Tritium Mixing Ratio Soundings

The discussion thus far has been concerned with the vertical variations in the tritium concentration. To examine the variation with altitude of the actual quantity of Tritium in the atmosphere, the concentration is weighted by the amount of water vapor present. This is done by multiplying the average MR by T. The product TMR, the tritium mixing ratio, is proportional to the total number of tritiated water molecules in the layer.

The TMR soundings (plotted in Appendix ii) were examined in much the same manner as the T soundings. All the TMR soundings except two in April exhibit a general decreasing trend with increasing altitude, but their variations are not directly related to the air mass classification or to the type of tritium sounding.

As mentioned above, in April 1966 there were two soundings in which a substantial increase in the TMR with altitude occurred. On these days both the MR and TMR were very low. On 21 April 1966 the TMR increase with altitude was the result of a very moist layer aloft, but on the 29th it was caused by a very strong subsidence inversion accompanied by a very high T. A third April sounding on the 15th did not exhibit a similar increase because the atmosphere was well mixed by convection throughout the layer of the sounding.

As water vapor of high T descends from above the tropopause, it mixes with water vapor of low T from the oceans or with moderate T water vapor from the continent. Thus its tritium concentration is diluted. A relationship should, therefore, exist between MR and T. A regression analysis between T and MR was conducted to determine how strong the relationship is. The results are shown in figure 5.

From the figure it may be seen that for a given MR the fall measurements exhibit a T approximately 500 tritium units (TU) lower than the spring and summer measurements (1 TU = 1 T atom/ 10^{18} H atoms). This difference is a reflection of the annual midsummer decrease in tropospheric radioactivity caused by a reduction in the stratospheric-tropospheric exchange. The regression analysis of T vs MR for the data in figure 5 excluded the autumn data and the 2980 TU value which is subject to doubt. The regression equation for the data is $T = 1046 - 58.2 MR$ and is plotted in figure 5. The regression line for the fall measurements was drawn visually and parallel to the calculated regression line. The correlation coefficient for T vs MR is 0.65 and the coefficient of determination is 0.42, i.e., 42 percent of the variation in T is caused by variations in MR.

Considering only the spring and summer data in figure 5, the data with $MR > 4$ g/kg are composed of summer measurements in the lower portion of the sounding. The measurements with $MR < 4$ g/kg consist of high altitude summer data and both high and low altitude spring data. This illustrates that T during the spring and summer is determined not so much by altitude or season as by the MR, that is, the degree of dilution of the stratospheric tritium.

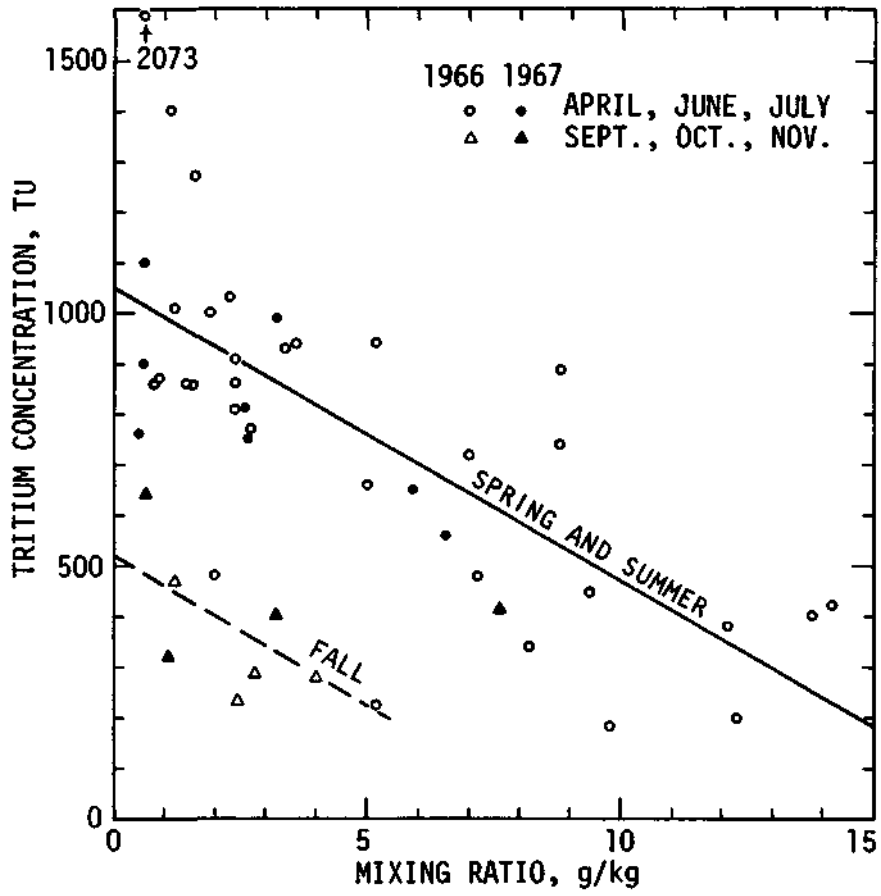

Figure 5. Tritium concentration vs mixing ratios at all altitudes, for central Illinois.

It may be further noted from figure 5 that the 1966 data are consistent with the 1967 data. This is puzzling because the concentration of artificial radioactive material in the air has generally been decreasing since the start of the nuclear test moratorium in January 1963. An examination of tritium measurements from several different locations in the United States published by the International Atomic Energy Agency (1963-1967) indicated that the T in precipitation decreased by a factor of two each year during 1963 through 1966. No explanation is available at present to account for this discrepancy other than the possibility that the 1967 data are not a representative sample.

Lake Michigan Soundings

A series of three soundings was made on 26 July 1966 to determine the horizontal variation of tritium and, if possible, the influence of Lake Michigan on the vertical distribution of tritium. Soundings were made at Kankakee, Illinois, at an airport 12 miles west of Waukegan, Illinois, and over the eastern edge of Lake Michigan, several miles offshore of Holland, Michigan. The soundings were begun at 0953, 1055, and 1351 CST, respectively. It was planned that soundings on the windward and leeward sides of Lake Michigan would show any possible influence of the lake while the soundings at Kankakee would be used as a control.

The lake area was under the influence of an MT air mass on the day of the flight with winds over the lake southwesterly at 6 m sec^{-1} at the flight altitudes, but calm at the surface. A detailed analysis of the weather conditions by Lyons and Wilson (1968) indicated that there was not a lake breeze effect on either side of the lake.

The results of the soundings are shown in Appendix ii. The soundings show a general decrease of tritium with increasing altitude, and, except for the lowest Kankakee sample, the measurements at all altitudes agree with each other to the extent that their counting errors overlap. The soundings thus indicate a fair degree of homogeneity of T in the atmosphere over distances of 325 km. The overland measurements were taken from the ground up while the overlake measurements were taken to within 67 m of the lake surface of 177 m MSL. The lowest Kankakee sample has a higher T than the other two lowest level samples, but, since the Waukegan sample should not have been influenced by the lake, it is difficult to attribute the difference between the Kankakee T and the Waukegan-Holland T's to the proximity of the lake.

The exchange of tritium between the atmosphere and surface of a large body of water is extensive as discussed by Bolin (1958). Bolin predicted that the molecular exchange of water vapor at the air-water interface along with sufficient vertical, turbulent exchange in the atmosphere would cause 68 percent of the tritium in the first kilometer of air above the lake to pass into the lake, assuming a wind speed of 3 m sec^{-1} .

Five surface water samples were taken from Lake Michigan within a month of the soundings and analyzed for tritium. The concentrations varied from 113 to 151 TU with an average of 138 TU. Yet the average concentration in the lowest leeward measurement taken from 67 to 280 m above the lake surface was three times greater than the average lake concentration and apparently was unaffected by the lake. The lack of exchange between the sampled air and the lake for the day investigated is attributed to a strong thermal inversion which existed throughout the depth of the lowest sample as measured by the aircraft thermometer (Appendix ii). The inversion prohibited the tritium concentrations present in the lowest levels to reach the sampling altitude by vertical mixing. It would have been of great interest to sample the lowest 67 m, but the means for doing so were not available at that time.

SUMMARY AND CONCLUSIONS

The tritium concentration in the lower troposphere over the Midwest usually increases by a factor of two from the surface to 5 km MSL. This results from the stratosphere being the source of water vapor of high tritium concentration. However, the absolute amount of tritium, that is, the number of tritium atoms per kg of air, a number proportional to the TMR, usually decreases with increasing elevation. This is the consequence of two factors. First, the lowest levels of the troposphere are rich in moisture and act as a trap for the descending tritium. The tritium diffuses down to the moist layer at a high concentration and becomes diluted. Once diluted it can return upward by convection only at a reduced concentration. The moist, lower atmosphere acts as a tritium sink in much the same manner as the oceans. The second factor responsible for the large amount of tritium in the moist layer is the evapotranspiration of water vapor from the surface with a moderate tritium concentration. The immediate effect of the evapotranspiration is

visible in the Midwest in the form of a tritium inversion in air masses arriving from the Gulf of Mexico which were originally of low T.

The actual variation in tritium concentration may be greater than is indicated with this data because in the 1966 data the samples were usually integrated over an altitude layer of 1 or 2 km. The samples taken through smaller altitude layers on 26 July 1966, however, do not exhibit a greater change with altitude than the rest of the soundings.

The soundings demonstrate several problems that may arise if tritium were used to trace water vapor through a storm. Since the concentration of tritium does not vary greatly within the first 5 km, processes such as fractionation during condensation and the molecular exchange of water vapor between raindrops and their environment (Bolin, 1958; Booker, 1965) may cause changes in the precipitation concentration of the same order of magnitude as the variations of tritium with different elevations.

REFERENCES

- Bolin, B., 1958: On the use of tritium as a tracer for water in nature, Proceedings of the Second United Nations Conference on the Peaceful Uses of Atomic Energy, Vol. 18, Geneva, Switzerland.
- Booker, D. V., 1965: "Exchange between water droplets and tritiated water vapour," Quart. J. Roy. Meteorol. Soc. , 91, 73-79.
- Bradley, W. E., and Pieter J. Feteris, 1966: Study of Rainout of Radioactivity in Illinois , Fifth Progress Report, AEC Contract AT(11-1)-1199.
- Eriksson, Erik, 1958: "The possible use of tritium for estimating groundwater storage," Tellus, 10, 472-478.
- Giletti, J. Bruno, Fernando Bazan, and J. Laurence Kulp, 1958: "The geochemistry of tritium," Trans. Amer. Geophys. U. , 39, 807-818.
- Houtermans, J., 1965: "Tritium in surface water of the North Pacific Ocean," 6th Carbon 14 and Tritium Dating Conf., CONF 650652, 565.
- Lyons, W. A., and J. W. Wilson, 1968: "The control of summertime cumuli and thunderstorms by Lake Michigan during non-lake breeze conditions," Satellite and Mesometeorology Research Project Paper No. 74, University of Chicago.
- Smith, R. Michael, 1966: Computations of the Fluxes of Tritium and Water Vapour over North America for July 1962, USAEC Contract NYO-2458-7.

APPENDIX i

An evaluation was made of several factors relating to the accuracy of the tritium sampling and counting techniques. Tests were performed with the equipment operated by the Water Survey, and control samples were sent to the contractors analyzing the water samples. The results are presented in table 1 and are discussed below.

In test 1 samples of dead water from Bastkarn mine, obtained by the International Meteorological Institute in Stockholm, were sent to both Isotopes, Inc., and to Stockholm. Independent analysis of the water by both laboratories showed good agreement and indicated the tritium concentration to be 28 TU.

In a second test three different water samples were split in half and sent to Isotopes with different labels to check the consistency of their analysis. Excellent agreement was obtained between the two independent analyses as is shown in table 1.

Several tests were conducted to check for contamination in processes relating to the collection of water samples in the molecular sieves and baking them out. In test 3 water vapor samples were taken simultaneously with two molecular sieves in parallel, sampling air from the same inlet. Analysis of the resulting water gave 736 and 732 TU, demonstrating the ability of the system to give consistent results.

Test 4 was similar to 3 except that dead water vapor was bubbled into two sieves, then baked out and analyzed. The results shown in table 1 indicate that one of the samples appeared to be dead, but the other one had a count of 106 ± 30 TU, indicating some contamination on the part of the sampling and bake-out system or in the analysis performed by Isotopes, Inc.

Test 5 was a determination of the sieve "memory", i.e., the amount of water remaining in the sieve after bake-out which would be released on the next bake-out. Tritiated water vapor from a spiked sample furnished by Isotopes, Inc., measured at $2.03 \pm 0.06 \times 10^4$ TU was bubbled into two molecular sieves. The samples were then baked out and set aside. Dead water was then bubbled into the sieves, baked out, and analyzed. The counts of 237 and 254 TU show that ~ 0.3 ml of the tritiated water remained in the sieves when quantities of water comparable to the usual samples are passed through the sieve. This memory would present a problem if samples of widely varying tritium concentrations

were taken, but in the atmospheric studies in this program, tritium concentrations generally vary by only a factor of two or three from sample to sample, making the memory insignificant.

Test 6 was a check for contamination of the laboratory environment. Consecutive samples were taken outside the building (196 TU), inside the laboratory (309 TU), and again inside the laboratory after it had been exposed to a watch with a glowing dial that did not emit beta radiation (602 TU). Ostlund (1967, Private Communication) has reported that watches which glow in the dark but do not give counts on an ordinary geiger counter can be a very strong source of tritium. The presence of the watch in the laboratory during the three hours of sampling doubled the tritium concentration, but background tritium levels of this magnitude will not contaminate samples during normal procedures. Nevertheless, as a precaution persons wearing watches not cleared as safe were not allowed in the laboratory during the 1967 season.

While no checks were made on the absolute accuracy of the contractors analyzing the water samples, their analyses as well as the techniques employed by the Water Survey in taking the samples appear to be consistent. Most of the samples were analyzed without enrichment. The accuracy of the 1966 analyses, as indicated by the counting error accompanying the data from Stockholm, appears to be about 20-35 TU. Isotopes, Inc., who analyzed the 1967 data quote their accuracy as ± 10 TU up to 300 TU and ± 3 percent for $T > 300$ TU.

TABLE 1

<u>Test No.</u>	<u>Description</u>	<u>TU</u>	<u>Contractor</u>
1	Dead water from Bastkarn mine	28 ± 9	I
	Dead water from Bastkarn mine	< 24	I
	Dead water from Bastkarn mine	27 ± 30	S
	Dead water from Bastkarn mine	0 ± 21	S
	Dead water from Bastkarn mine	24 ± 11	I
2	Tritium analysis consistency, sample split	334, 338	I
	Tritium analysis consistency, sample split	278, 281	I
	Tritium analysis consistency, sample split	198, 199	I
3	Water vapor samples taken in parallel	736, 732	S
4	Dead water from sieve	0±21, 106±30	s
5	20cc dead water following tritiated water	237 ± 13	I
	25cc dead water following tritiated water	254 ± 15	I
	15cc dead water control in a 3rd sieve	< 23	I
6	Outside laboratory	196	
	Inside laboratory	309	
	In laboratory contaminated by a watch	602	

I = Isotopes, Inc.

S = International Meteorological Institute in Stockholm, Sweden

APPENDIX ii

The following graphs present tritium and tritium mixing ratio soundings, plus temperature and humidity soundings from Peoria, Illinois, for the designated dates.

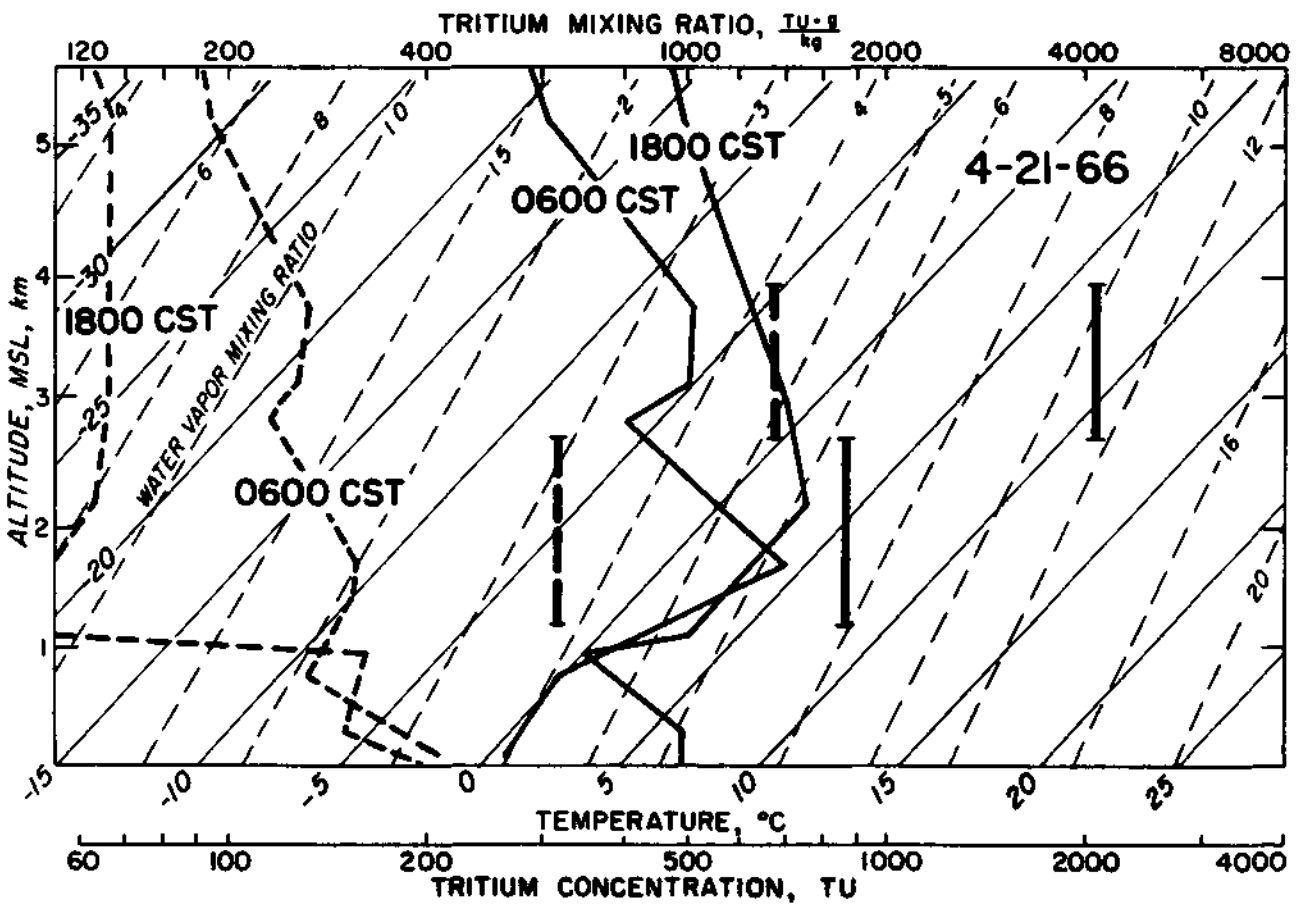
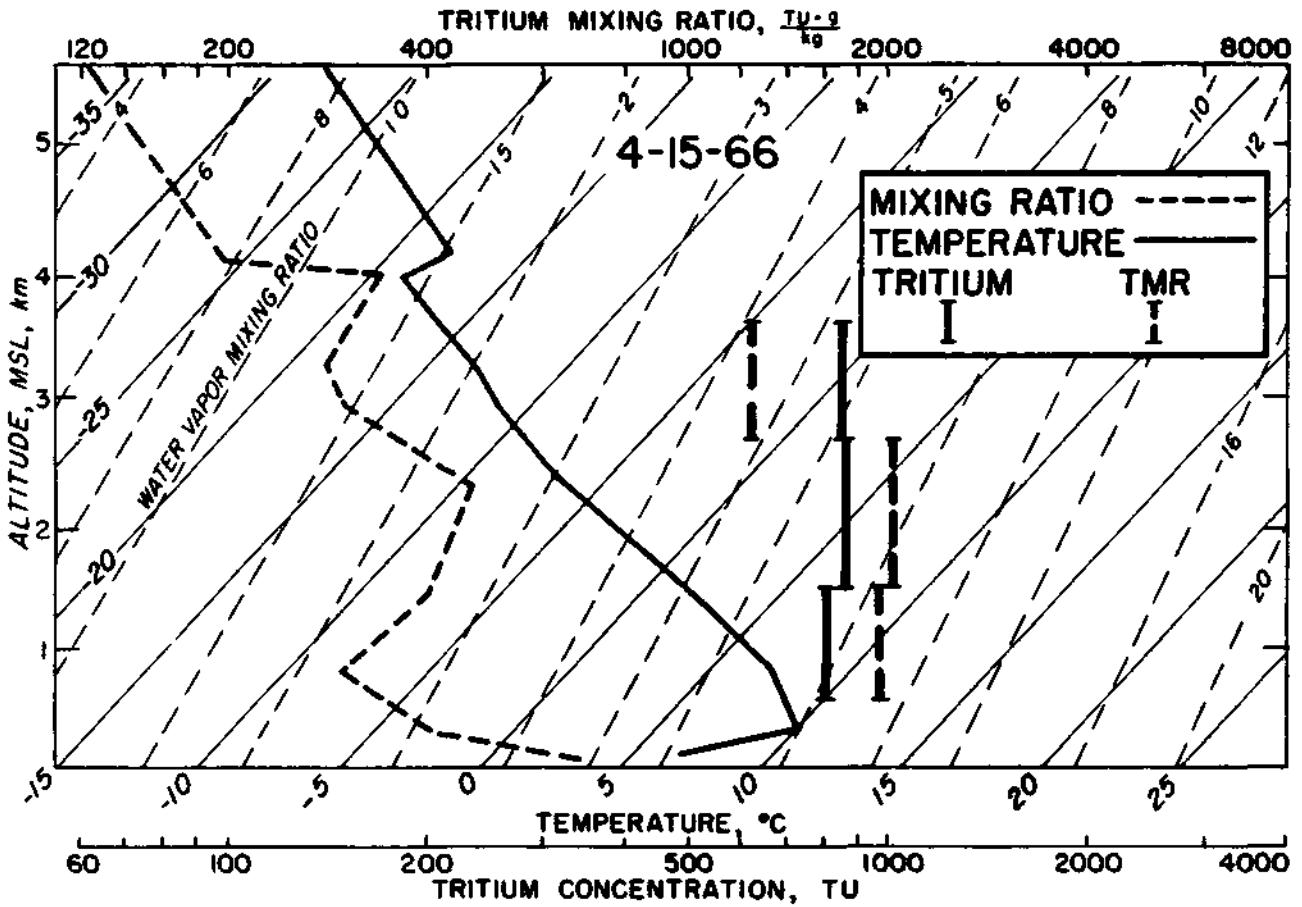

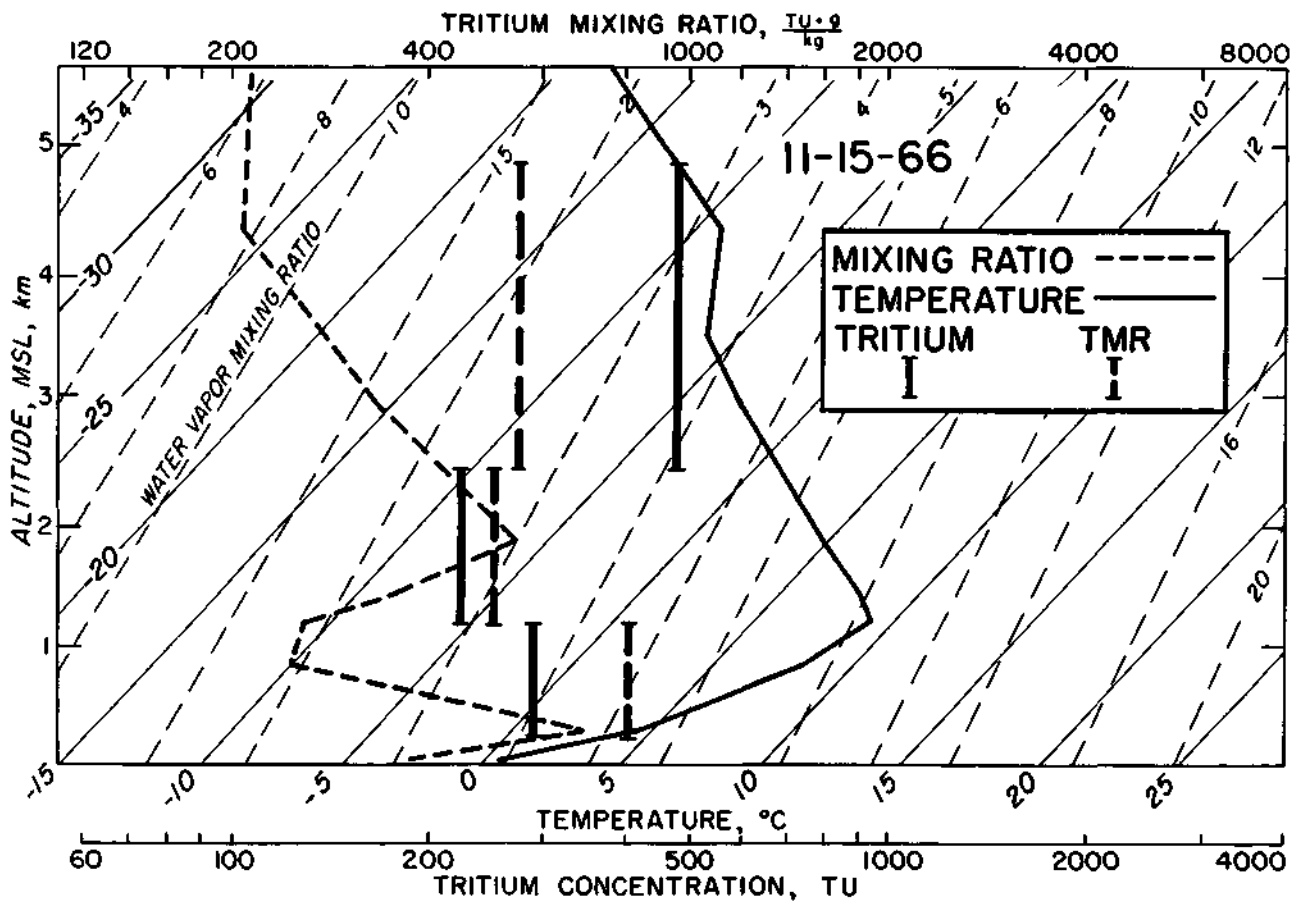
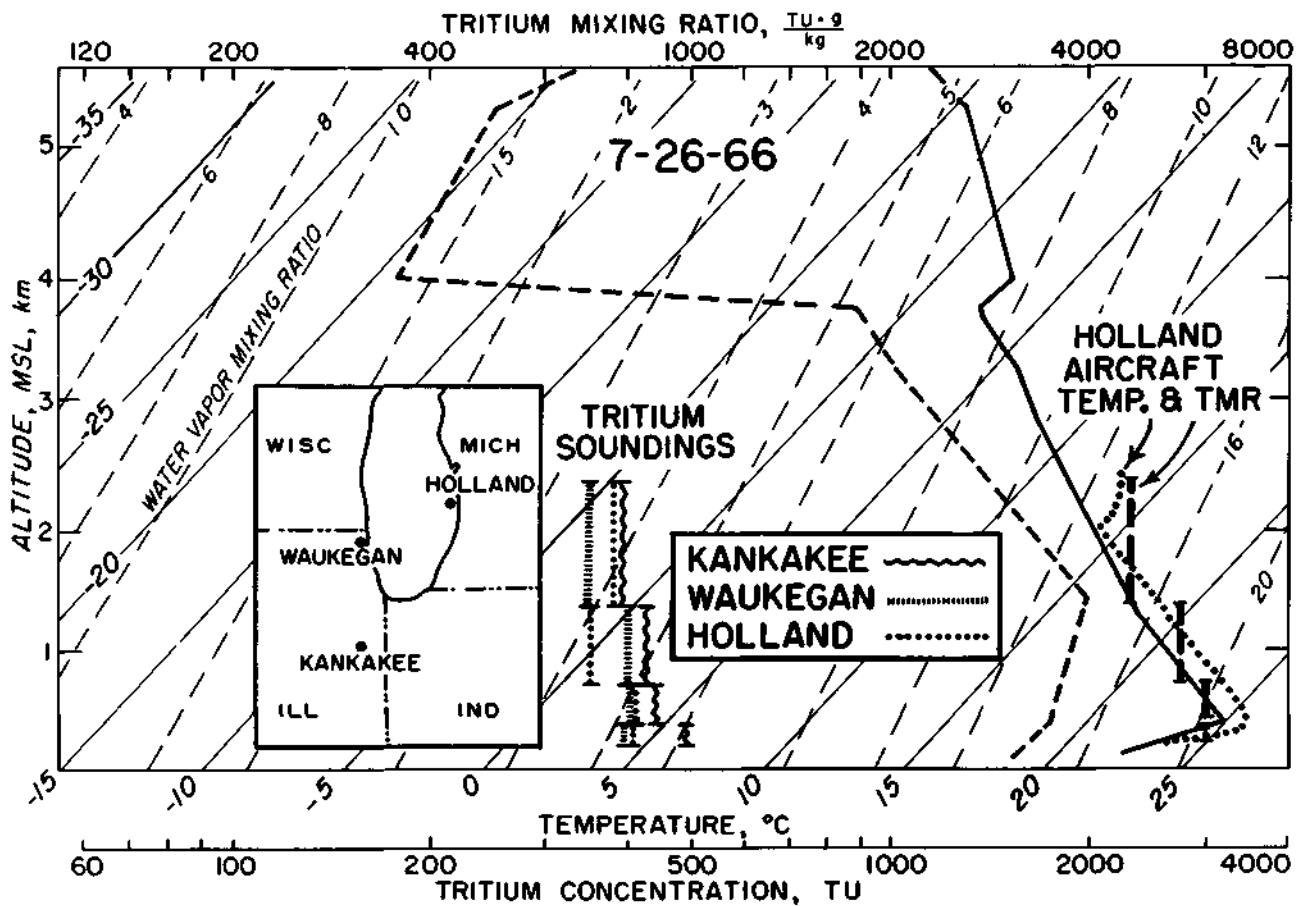

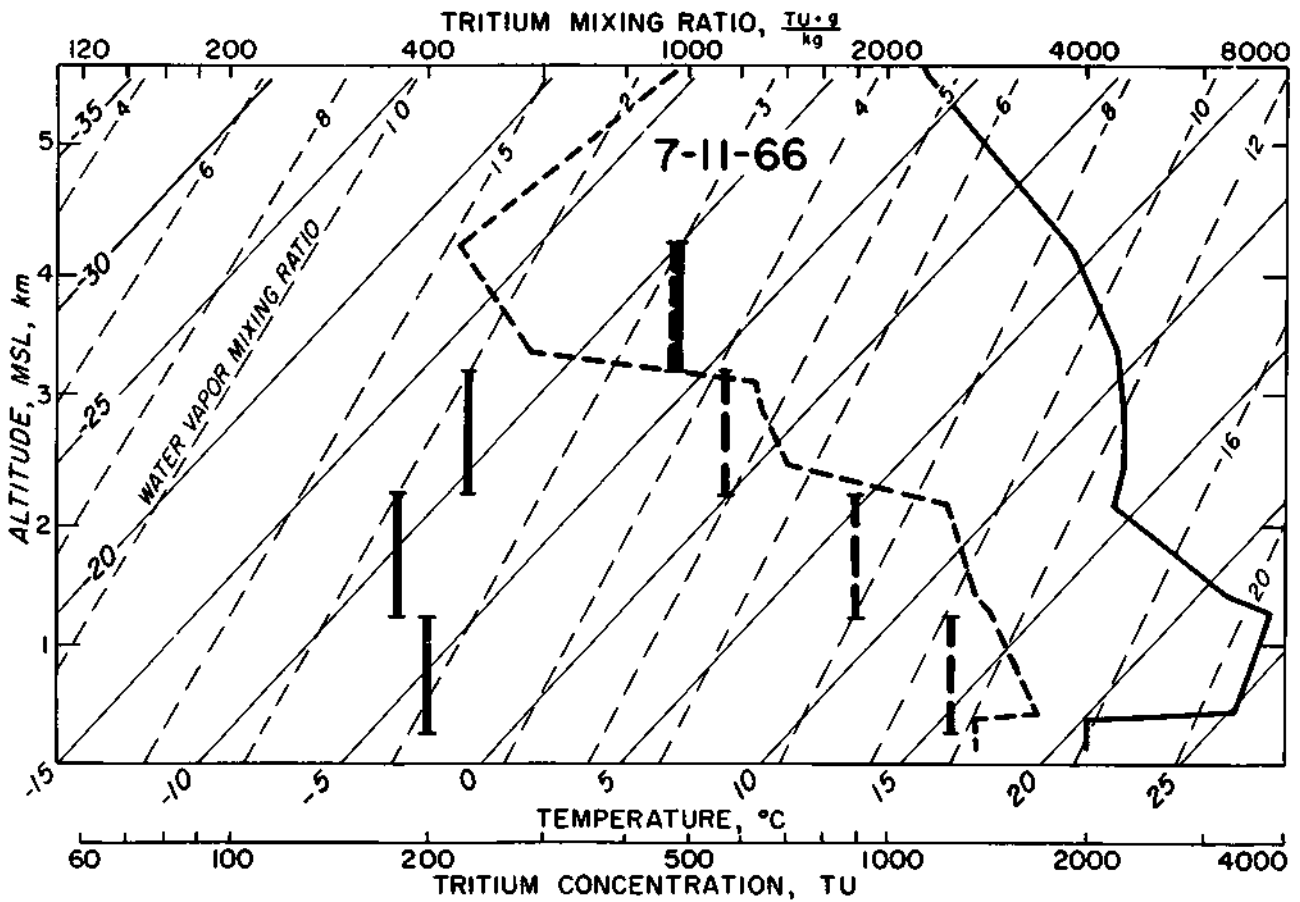
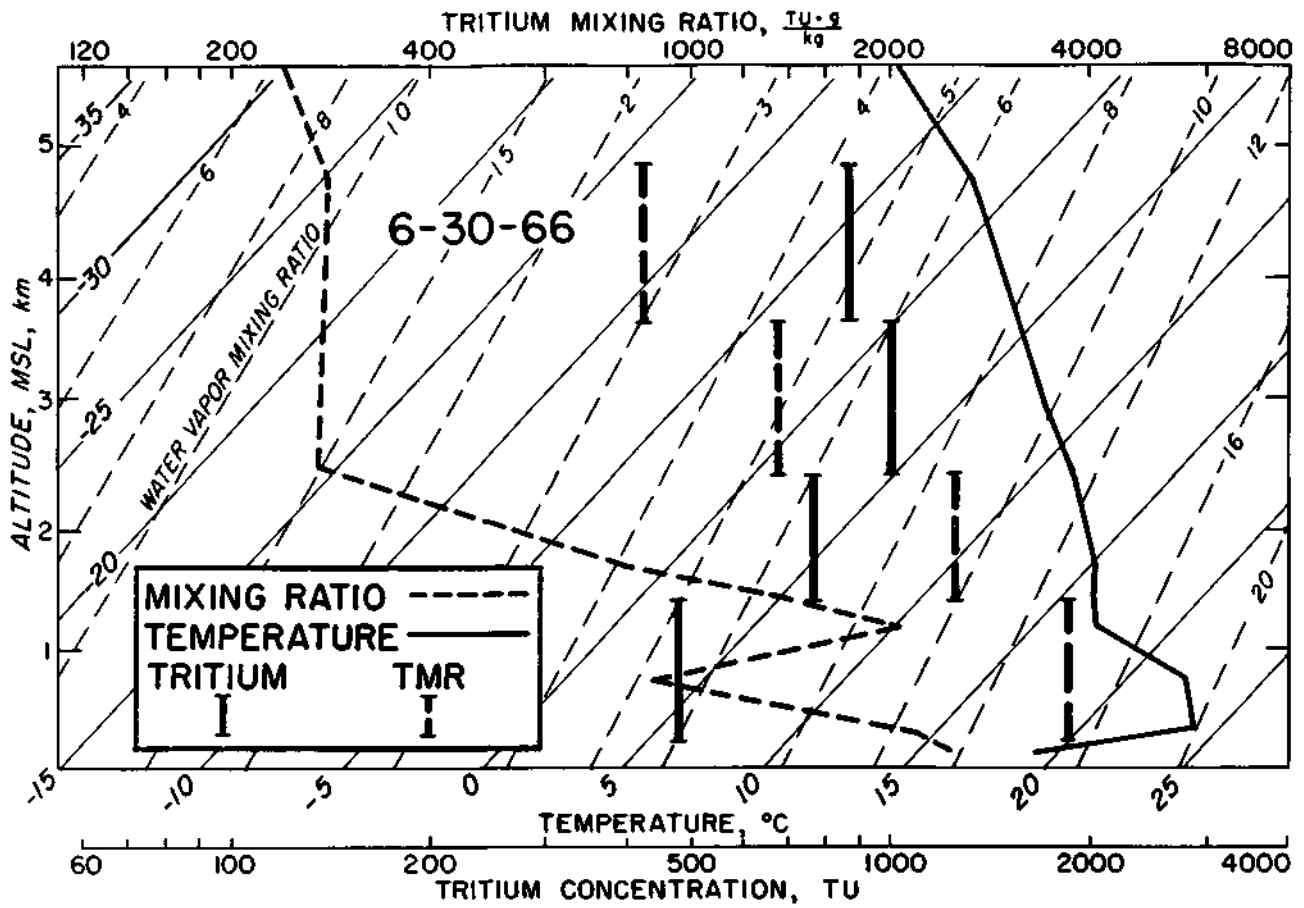

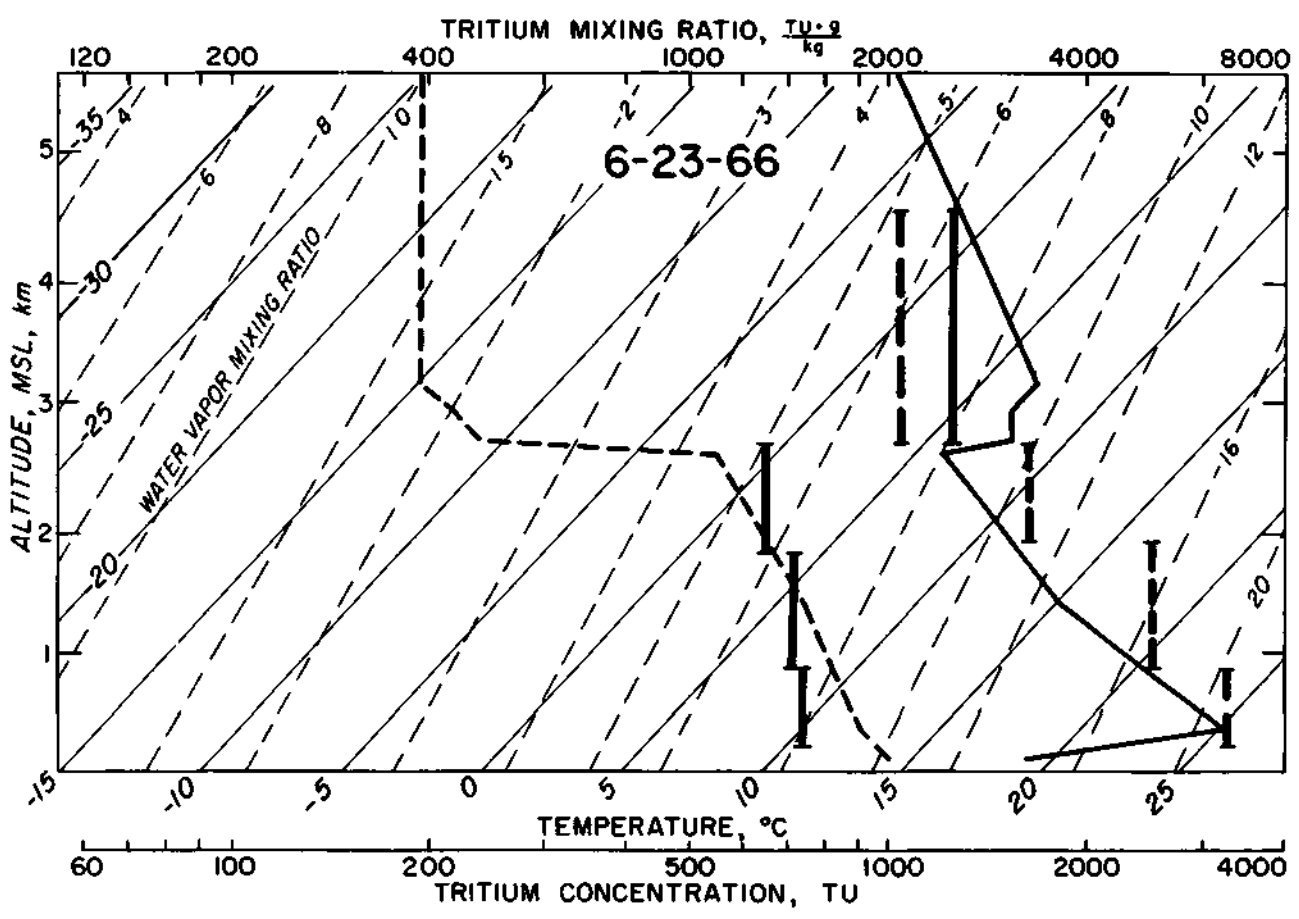
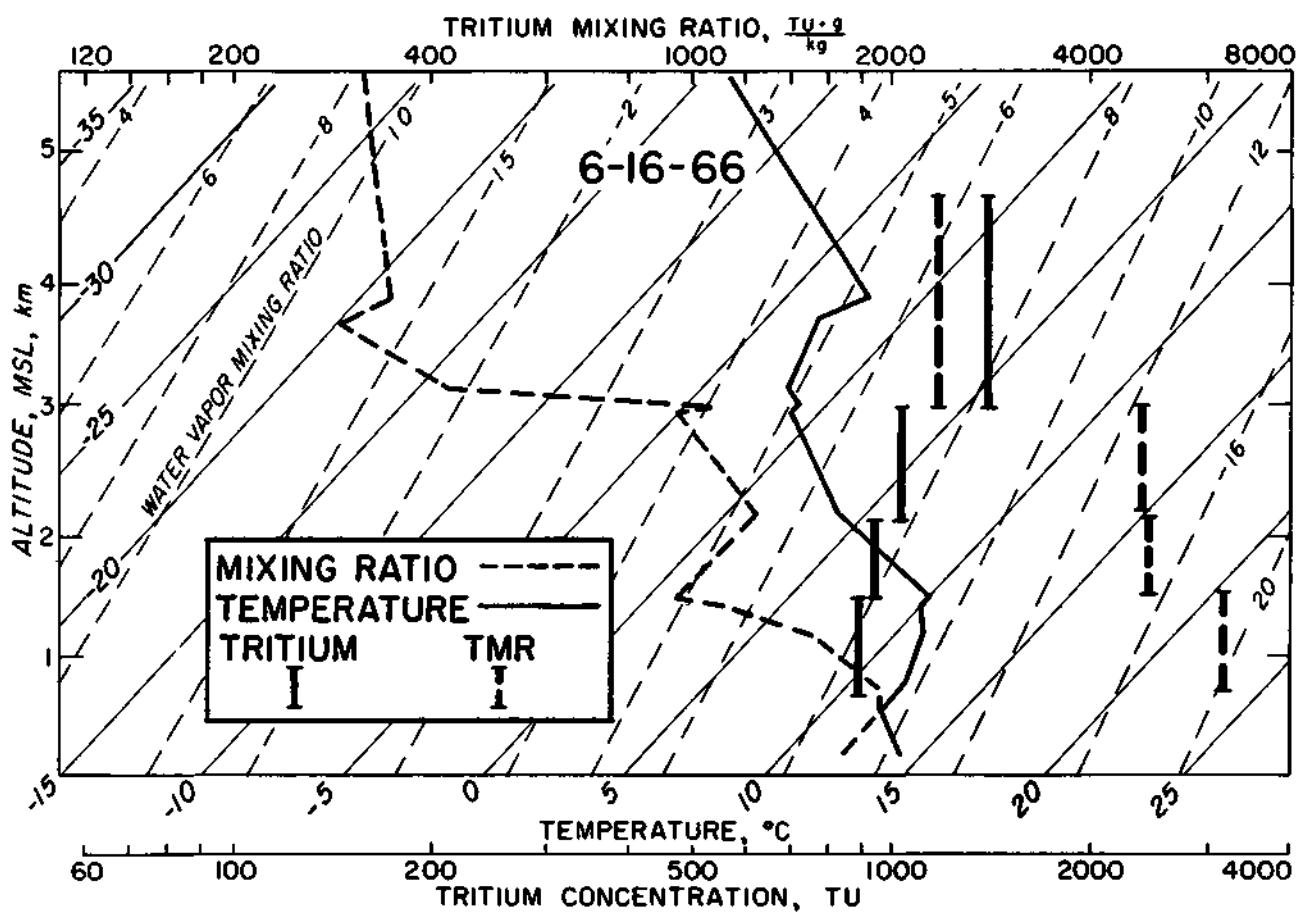

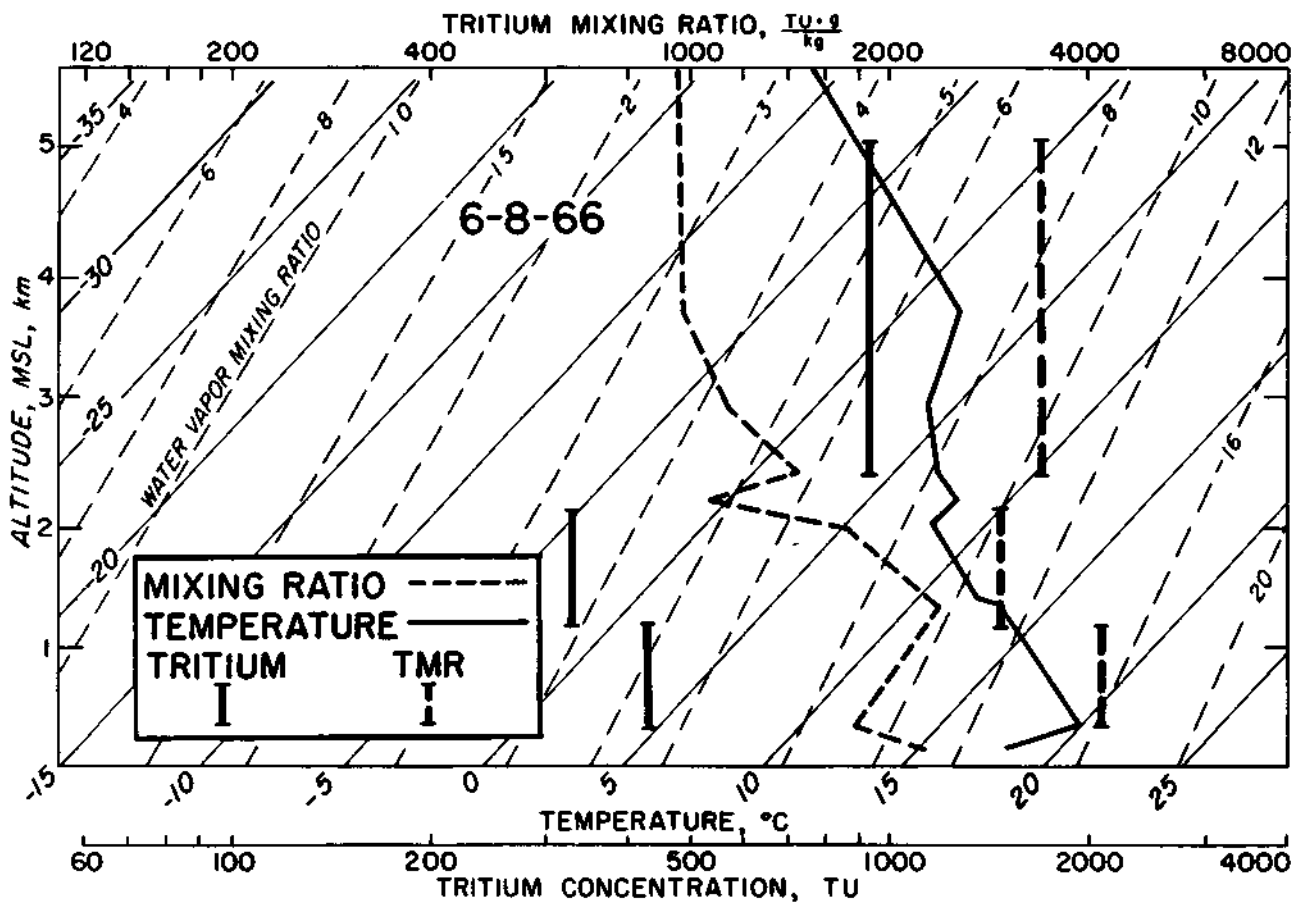
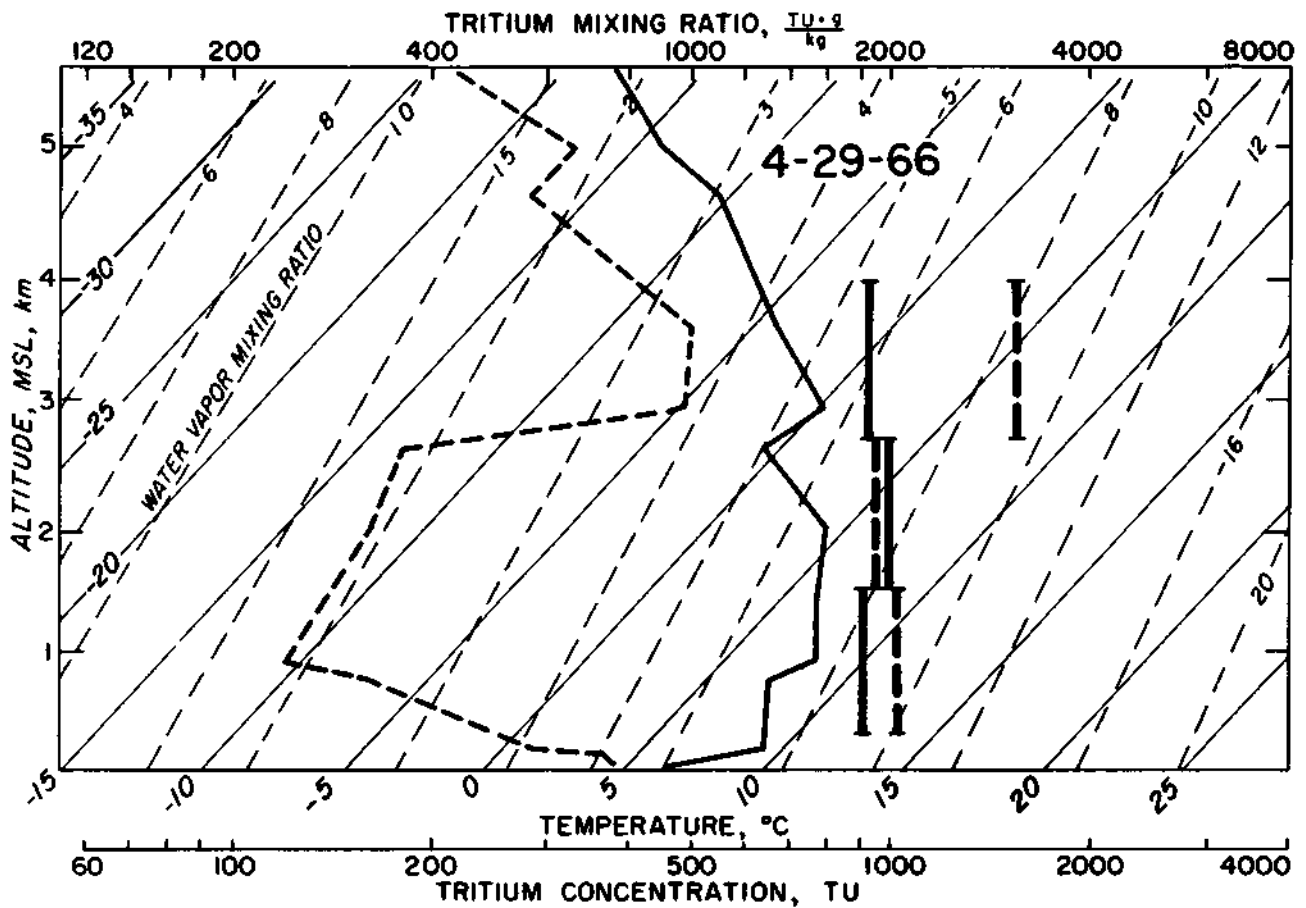

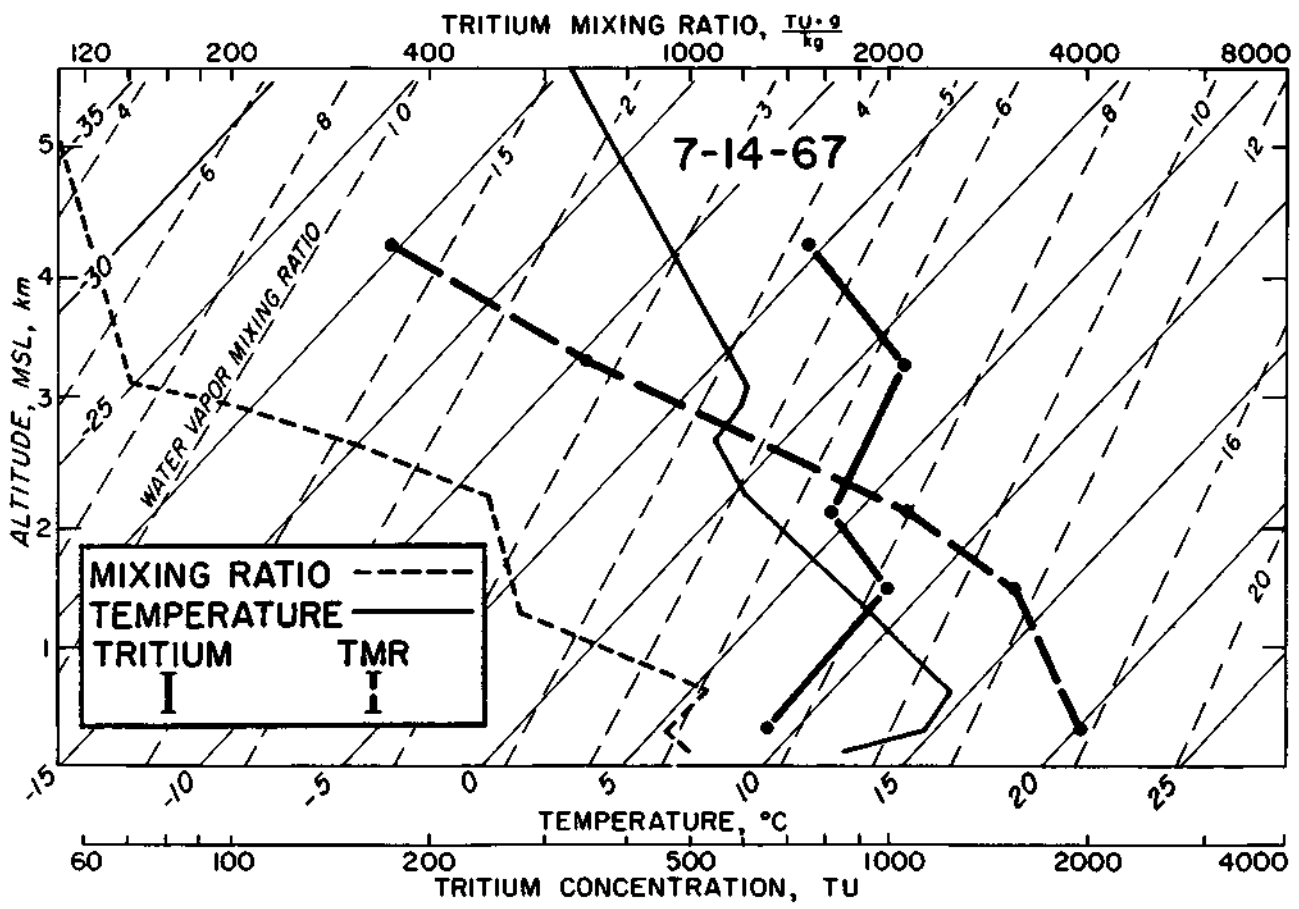
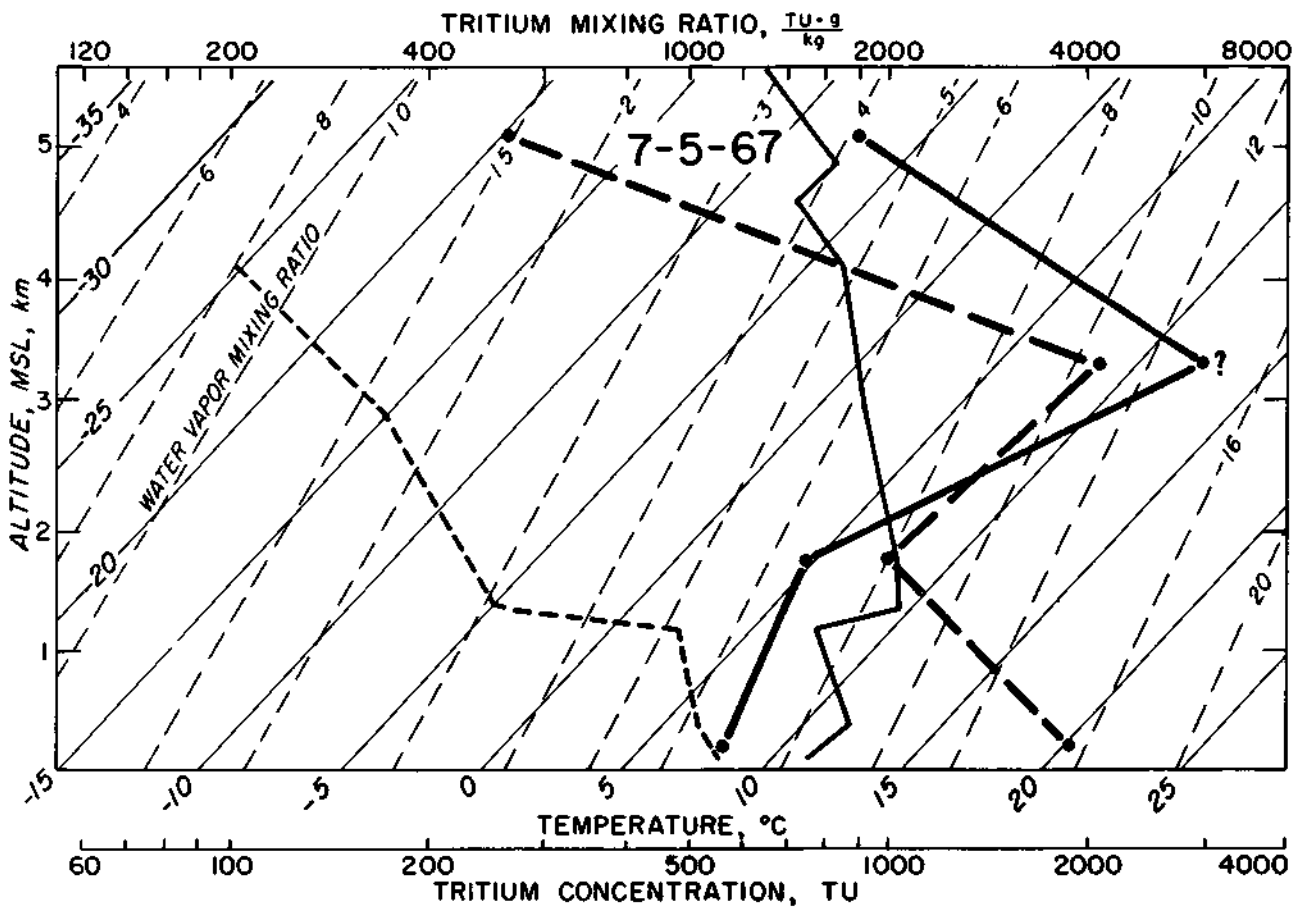

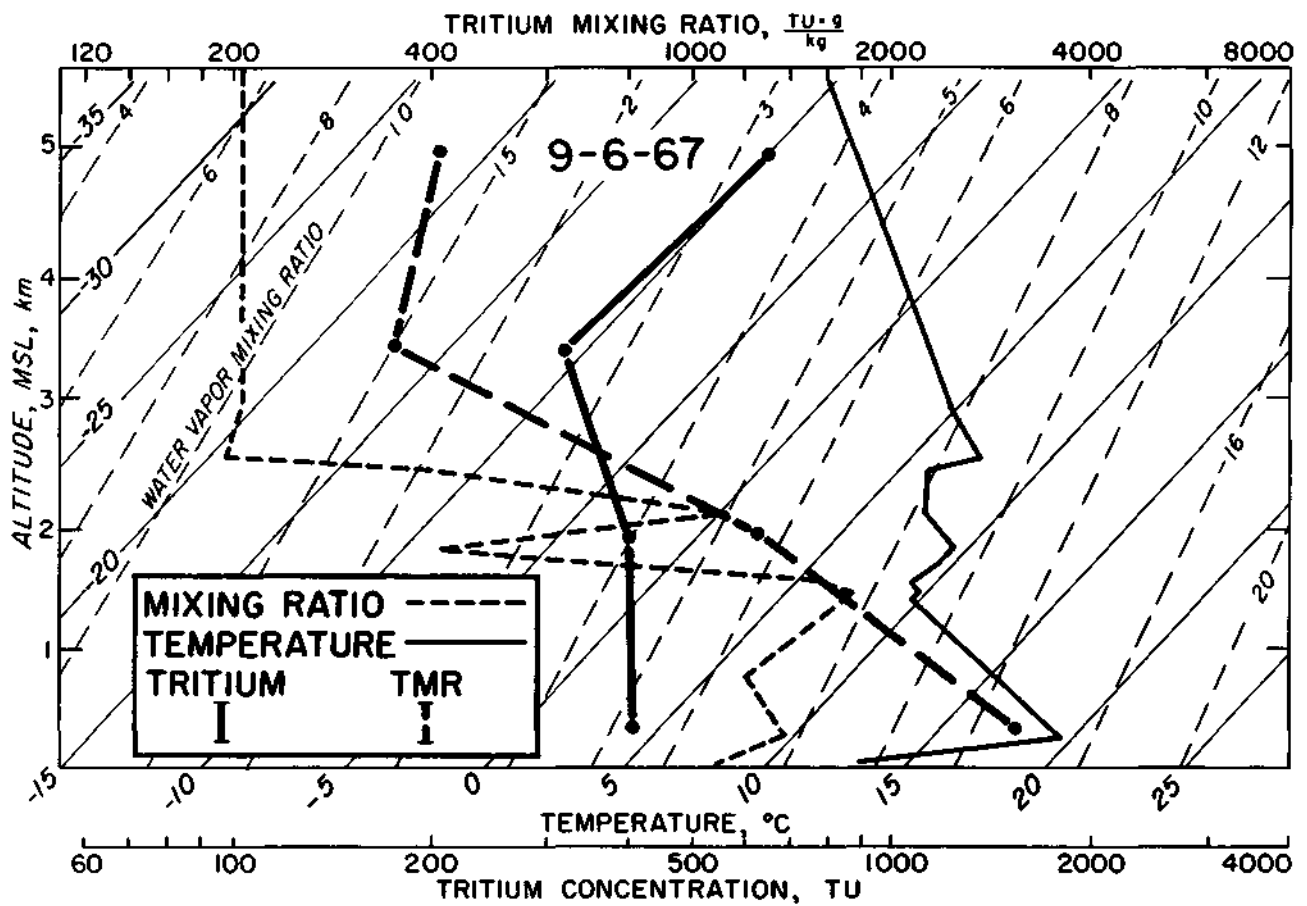

APPENDIX C

Reports prepared under the
Contract Number AT(11-1)-1199
U.S. Atomic Energy Commission

- C00-1199-1 = First Progress Report - January 31, 1963 - F. A. Huff
"Study of Rainout of Radioactivity in Illinois"
- C00-1199-2 = Second Progress Report - January 31, 1964 - F. A. Huff
"Study of Rainout of Radioactivity in Illinois"
- C00-1199-3 = SWS Reprint Series No. 46 - F. A. Huff
"Radioactive Rainout Relations on Densely Gaged Sampling Networks"
- C00-1199-4 = SWS Reprint Series No. 45 - F. A. Huff and G. E. Stout
"Distribution of Radioactive Rainout in Convective Rainfall"
- C00-1199-5 = Third Progress Report - January 31, 1965 - F. A. Huff
"Study of Rainout of Radioactivity in Illinois"
- C00-1199-6 = Research Report No. 1 - March 1965 - F. A. Huff
"Radioactive Rainout Relations in Convective Rainstorms"
- C00-1199-7 = Research Report No. 2 - October 1965 - P. J. Feteris
"1964 Project Springfield Studies"
- C00-1199-8 = Fourth Progress Report - October 1965 - F. A. Huff
"Study of Rainout of Radioactivity in Illinois"
- C00-1199-9 = Reprint - Vienna Paper - Symposium on the Use of Isotopes in
Hydrology - G. E. Stout and F. A. Huff - November 14-18, 1966
"Rainout Characteristics for Hydrologic Studies"
- C00-1199-10 = Fifth Progress Report - December 1966 - W. E. Bradley and
P. J. Feteris
"Study of Rainout of Radioactivity in Illinois"
- C00-1199-11 = Reprint - February 10, 1967 - W. E. Bradley and Gordon E. Martin
"An Airborne Precipitation Collector"
- C00-1199-12 = Reprint - TELLUS - October 1967 - F. A. Huff and G. E. Stout
"Relation Between Ce¹⁴⁴ and Sr⁹⁰ Rainout in Convective Rainstorms"
- C00-1199-13 = Conference at Chalk River Laboratories, Canada - September 11-14,
1967 - F. A. Huff and G. E. Stout
"Time Distributions of Radioactivity and Chemical Constituents
in Rainfall"
- C00-1199-14 = Sixth Progress Report - November 1967 - F. A. Huff, W. E. Bradley
and P. J. Feteris
"Study of Rainout of Radioactivity in Illinois"

- COO-1199-15 = Research Report No. 3 - July 1968 - John W. Wilson and Parker T. Jones III
"Tracing Tropospheric Radioactive Debris by Isentropic Trajectories"
- COO-1199-16 = SMRP Research Paper No. 74 - June 1968 - Walter A. Lyons and John W. Wilson
"The Control of Summertime Cumuli and Thunderstorms by Lake Michigan During Non-Lake Breeze Conditions"
- COO-1199-17 = Seventh Progress Report - November 1968
"Study of Rainout of Radioactivity in Illinois"