

ISWS-74-CIR119

Circular 119

STATE OF ILLINOIS

DEPARTMENT OF REGISTRATION AND EDUCATION



***Design and Performance
of Chlorine Contact Tanks***

by V. KOTHANDARAMAN and RALPH L. EVANS

ILLINOIS STATE WATER SURVEY

URBANA

1974

CONTENTS

	PAGE
Abstract	1
Introduction	1
Literature review.	2
Objective and scope.	3
Materials and methods.	3
Acknowledgments.	4
Treatment plant contact units.	4
Bloomington-Normal Sanitary District (BNSD)	4
Aurora Sanitary District (ASD).	9
Pekin Waste Treatment Plant (PWTP).	13
Discussion.	18
Hydraulic model studies.	20
Model description.	21
Results of model studies.	24
Air agitation of treatment plant effluents.	26
Effects on total chlorine residual.	27
Effects on bacterial reduction.	27
Split chlorination of secondary waste effluents	28
Experiments.	29
Results.	31
Summary.	33
Recommendations.	35
References.	36

DESIGN AND PERFORMANCE OF CHLORINE CONTACT TANKS

by V. Kothandaraman and Ralph L. Evans

ABSTRACT

Most existing chlorine contact tanks suffer from serious drawbacks of dead spaces, short circuiting, and solids accumulations that subsequently putrefy and exert undue chlorine demand. Hydraulic model studies of chlorine contact tanks indicate that air agitated, baffled contact units have better flow characteristics than just baffled units or air agitated contact tanks without baffles. Air agitation does not result in a loss of total chlorine residuals, and it improves the bactericidal efficiency of chlorination. Also air agitation eliminates the problems caused by solids accumulation in the contact units. Split chlorination does not appear to be an advantageous modification in chlorination practice.

INTRODUCTION

Continuous disinfection of waste water effluents likely to contain fecal coliform bacteria has become mandatory in the state of Illinois. The pertinent rule of the Illinois Pollution Control Board regarding effluent standards stipulates that "no effluent shall exceed 400 fecal coliforms per 100 ml after July 31, 1972" This rule, in effect, requires year-round disinfection practices, even in winter months.

In Illinois, as in most states, the principal method used for the disinfection of treated effluents is chlorination. Since chlorination practices in waste water treatment entail a significant amount of capital outlay and recurring expenditure, it is important that the process be effective and efficient. Any improvement in the efficiency over that obtainable with the current chlorination practice should result in better economy.

The design of chlorine contact tanks on the basis of the concept of plug flow assumes that the fluid entering the contact chamber is evenly distributed over the entire cross section of the basin and moves in parallel stream lines with a constant and uniform velocity to the outlet. It is tacitly assumed that each particle of fluid entering the basin remains in it for a period called the 'theoretical detention time.' However, in actual practice, particles of fluid entering at the same time are found to have unequal times of passage, and a significant portion of the fluid leaves the tank with a residence time considerably less than the theoretical detention time.

Consequently, to maintain the effectiveness of chlorine contact tanks for the disinfection of waste water effluents, the chlorine dosage must be increased resulting in significant increases in operational costs. In addition to being beset with the problems of dead spaces and short circuiting, contact tanks also suffer from the problems of solids accumulations that putrefy and exert undue chlorine demand. These accumulated solids must be removed periodically, which involves varying degrees of human effort and results in nuisance conditions and interrupted operations. These deficiencies in turn reduce the bacterial removal efficiencies of the contact units.

Literature Review

Though there has been an increasing number of investigations concerning the chlorination aspects of waste water treatment in recent years, unified attempts to delineate the physical, chemical, and biological performance characteristics of chlorine contact tanks have been scarce. Most investigators restricted their objectives either to the hydraulic flow characteristics in model and prototype contact tanks¹⁻⁶ or the bactericidal characteristics of chlorine in batch or continuous flow experiments conducted in the laboratory.^{6,7} In actuality, these two aspects operate in conjunction with each other and the results obtained by separating them are found to be at variance with those found in the field units.

Louie and Fohrman¹ conducted model studies for the post chlorination facility for the Calumet treatment plant at Chicago, and estimated that savings in construction costs of \$284,000 were realized as a result of model studies. Of primary concern to them was the elimination of hydraulic short circuiting and solids deposition. Another concern was the proper initial mixing and distribution of chlorine at the head end of the contact basin. A contact chamber with baffles and directional vanes was adopted in the final design. Directional vanes in the flow path are a departure from the traditional design practice of chlorine contact tanks. Even though waste treatment plant effluent was used in their model study, there was no effort to quantitatively evaluate the solids deposition problem and the increase in the bacterial kill efficiency due to the proposed modifications. As will be discussed later, bactericidal efficiency in a contact tank was found to be less in the presence of putrefying solids, as opposed to the efficiency in tanks where settled solids were removed frequently, even though the initial chlorine dosage rates and the mean residence periods were comparable.

Marske and Boyle² carried out tracer studies to delineate the hydraulic flow-through characteristics on a number of existing treatment plant contact basins. The configurations of the contact basins examined by them were circular, cross-baffled rectangular, longitudinally baffled rectangular, and un-baffled rectangular. They concluded that a longitudinally baffled serpentine flow basin and a circular contact basin in the form of an annular ring around a secondary clarifier were the best configurations investigated by them. No other aspect of contact chamber design was considered in their study.

Sawyer³ studied the hydraulic flow characteristics of a model circular chlorine contact tank and found that there were severe short circuiting problems and nonuniform distribution of the flow. Warwick⁵ conducted tracer studies on a circular chlorine contact tank and concluded that circular contact tanks are not likely to perform efficiently because of inherent hydraulic deficiencies.

Stephenson and Lauderbaugh⁴ encountered severe short circuiting problems because of poor flow patterns in the rectangular chlorine contact tank of the Kokomo, Indiana, waste treatment plant. They reported significant improvement in the hydraulic flow pattern by installing a 'maze' of baffles. These authors did not indicate whether the solids accumulation problem that existed prior to the modifications was eliminated or not.

Collins and Selleck⁶ conducted a series of experiments on chlorination with primary treated waste water in stirred batch reactors and continuous flow reactor models. They emphasized in their study the need for contact basins designed to approach ideal plug flow reactors. The significant findings of their study are:

- 1) The germicidal activity of the chlorine residual decreased with time.
- 2) The coliform bacteria were more conservative indicators of the process efficiency of waste water chlorination than were fecal coliform bacteria.
- 3) The effect of initial mixing on process efficiency was profound.
- 4) Reactor backmixing caused a decrease in the efficiency of the waste water chlorination process.

Literature is replete with information on laboratory studies of waste water chlorination. A review of these is beyond the objective of this report.

Objective and Scope

The primary objective of this work was to evaluate the physical, chemical, and bacteriological performance characteristics of chlorine contact tanks and especially to focus on the shortcomings of using the current design criterion for contact chambers based solely on the volume displacement concept, i.e., the theoretical detention time. Methods for improving the effectiveness and efficiency of contact basins based on model and bench scale studies were explored as a part of the effort toward developing rational design criteria for contact basins.

Total performance characteristics were evaluated for contact tanks at three waste treatment plants serving the Illinois cities of Bloomington, Aurora, and Pekin. The efficacy of mixing the contents of chlorine contact tanks with compressed air as a method for improving the hydraulic flow-through characteristics and for minimizing solids deposition problems was investigated with a hydraulic model. The effect of air agitation on total residual chlorine and on bacterial removal efficiencies was investigated in batch reactors with the use of secondary waste treatment plant effluents. The merit in the suggestion of Imhoff and Fair⁸ to employ split chlorination for the disinfection of a waste stream was examined.

Materials and Methods

The hydraulic flow-through characteristics of the contact tanks were investigated with the use of rhodamine-B dye. The dye concentrations in the collected samples were determined with a fluorometer (Model 110, G. K. Turner Associates). The instrument was calibrated by using standard dye solutions each time samples were analyzed, and 546 and 570 millimicron filters were used as primary and secondary filters, respectively. The standard dye solutions and the sample dye solutions were allowed to equilibrate to room temperature to avoid the need to make temperature corrections for the differences in temperature between the two solutions.

Total residual chlorine concentrations were determined by using a Wallace and Tiernan amperometric titrator. A preliminary investigation to evaluate the differences between the forward and backward titration procedures⁹ indicated that the two procedures yielded identical results. Consequently, the forward titration procedure was used in determining total residual chlorine concentrations.

Aliquots for bacteriological analyses were collected in autoclaved sample bottles containing a 10 percent sodium thiosulfate solution at the rate of 0.1 milliliter per 4 ounces of sample volume, in accordance with Standard Methods.¹⁰ The bacterial samples were preserved in ice whenever necessary, and there was a maximum lag of about 6 hours between the sample collection and incubation for bacterial density determinations.

Determinations for total coliforms (TC), fecal coliforms (FC), and fecal streptococci (FS), were carried out by membrane filter techniques. Total coliform counts were evaluated by the M-Endo agar LES two-step procedure. M-FC broth and M-Enterococcus agar were used for FC and FS determinations, respectively.

A study by Lin⁷ suggests that the use of the LES two-step membrane filter procedure is comparable to the completed multiple tube (most probable number, MPN) technique for TC enumeration in chlorinated secondary effluents. His work also indicates that FC recovery, with the membrane technique (M-FC broth) in chlorinated waste effluent, is well correlated with the values obtained employing confirmed MPN in EC broth.

Although Standard Methods¹⁰ cautions against the reliability of the membrane filter technique on chlorinated samples, it is felt that the procedure employed in this work is satisfactory for comparative purposes.

Suspended matter was determined by the difference in weights between total residue and dissolved matter. After filtering the suspended material with Whatman No. 1 paper, the residues were dried on a steam bath, desiccated, and weighed. For determining the volatile fraction by dry weight of settled solids, the residues were dried at 110 C for 16 hours, desiccated, and weighed. The volatile fraction was then determined from the loss of weight on ignition in a muffle furnace at 600 C for 1 hour.

Acknowledgments

This study was conducted as part of the work of the Water Quality Section of the Illinois State Water Survey, Dr. William C. Ackermann, Chief. The authors extend special thanks to Howard L. Southerland and Ronald Heck both of the Bloomington-Normal Sanitary District, Mr. Donald Gasper of the Pekin waste treatment plant, and Mr. Malcolm Lloyd of the Aurora Sanitary District for their enthusiasm and cooperation in conducting this study at their respective plants. Several of the authors' colleagues, notably Donald H. Schnepfer, Shundar Lin, Davis Beuscher, William T. Sullivan, and Pamela A. Martin, participated in one phase or another of this endeavor. Their assistance and advice are gratefully acknowledged. Illustrations were prepared by the Graphic Arts Section under the supervision of John W. Brother, Jr.; Mrs. J. L. Ivens and Mrs. P. A. Motherway edited the final report; and Suzi L. Scherbroeck typed the camera-copy.

TREATMENT PLANT CONTACT UNITS

Bloomington-Normal Sanitary District (BNSD)

Two separate and different treatment processes are used for treating waste water at Bloomington. An activated sludge plant processes a waste flow of about 3 million gallons per day (mgd) and a fixed nozzle trickling filter plant handles a flow of about 8 mgd. The effluent from each facility is chlorinated separately before discharge to the receiving stream. The general layout of the treatment facility is shown in figure 1. A grit chamber was modified to serve as a chlorine contact chamber for the activated sludge plant and it is of the longitudinally baffled rectangular type, as shown in figure 2a. The contact basin for the trickling filter plant is of the cross-baffled rectangular type, shown in figure 2b. Chlorine is applied at the head end of the first bay in each of the tanks by means of perforated pipe diffusers.

In the contact tank for the activated sludge plant, the dye tracer was added at the outlet end of the final settling tanks. The initial time was reckoned from the time the dye appeared at the head end of the contact tank. There was a time lag of approximately 5 seconds or less between the time the dye was added and the initial appearance of the dye in the contact tank. For the trickling filter plant, the dye was added directly at the head end of the chlorine contact tank. Samples were obtained at frequent intervals at the outlet ends to define the time-tracer concentration curves adequately.

Simultaneously with the dye test, samples were obtained from the inlet and outlet ends of the chlorine contact tanks for pH and temperature measurements, residual chlorine determinations, and bacterial examinations. Composite samples of waste water flows covering a period of about 2 hours were obtained at both the inlet and outlet ends for determining suspended matter. Samples of the settled solids in the contact tank for the trickling filter plant were obtained with an interface sampler.¹¹ The sills of the outlet pipes for this tank are 8 feet from the bottom of the tank, making it very cumbersome to remove accumulated solids routinely from the tank bottom. On the other hand, the outlet of the contact tank for the activated sludge plant is an overflow rectangular weir with a movable sluice gate 5 to 75 feet deep. The tank bottom is cleaned frequently of settled solids by pulling the sluice gate and scouring out the accumulated solids.

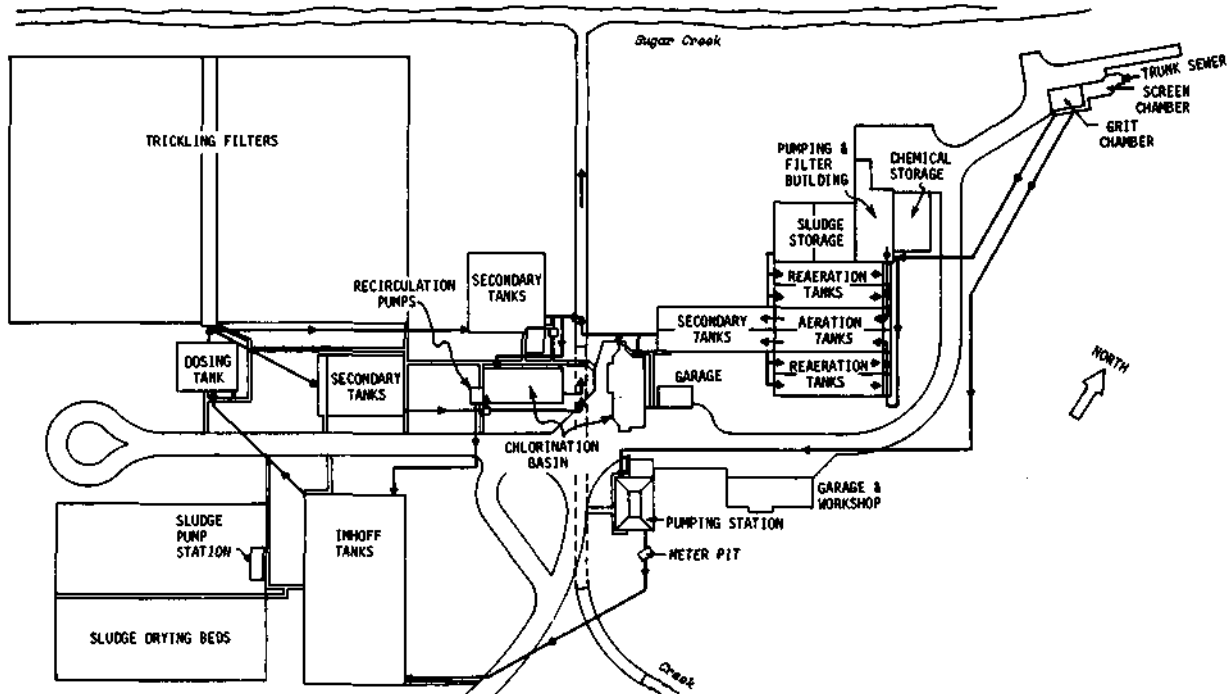

Figure 1. Flow diagram of water pollution control plant, BNSD

Results for Activated Sludge Plant Contact Unit. The hydraulic flow-through characteristics were studied at flow rates of 2.43, 2.84, and 2.88 mgd. Three dye tests were carried out at the flow rate of 2.43 mgd to examine whether the flow-through characteristics were stable. Figure 3a shows the time-tracer concentration curve at this flow rate. The flow characteristics of the tank were very stable, and this was again confirmed by two test runs at 2.88 mgd.

Table 1 shows the results of analysis of all the dye tests at the three flow rates. The theoretical detention times (volume displacement) of the contact tank at the three flow rates are 49.3, 42.2, and 41.6 minutes, respectively. The tracer flow-through curves were evaluated by central tendency parameters defined as follows:

- t_i = elapsed time between dosing of the tracer and initial appearance of the tracer at the sampling point
- t_{10} = time for 10 percent of the injected tracer to pass the sampling point
- t_{90} = time for 90 percent of the tracer to pass
- t_p = time for the peak concentration to pass
- t_g = time to the center of gravity of the flow-through curve
- t_m = time for 50 percent of the injected tracer to pass

The Morrill index, the ratio of $t_{90}:t_{10}$, is taken as an indicator of the extent of dispersion in the contact chamber. In the case of ideal plug flow, the Morrill index has a value of 1.0. The closer the index of a flow-through curve is to 1.0, the more nearly it approaches the ideal condition of plug flow.

Although the configuration of the tank is narrow and long and conducive to plug flow with minimum axial dispersion, the first appearance of the tracer at the outlet end is about 16 minutes after dosing with dye. The inlet to the tank is in the form of piped flow without a baffle arrangement (figure 2a) to distribute the flow across the tank. Consequently, the leading edge of the dye cloud passed the first bay in less than 1 minute in spite of the fact that the theoretical detention time of this bay is 39 percent of the total detention time of the tank. The incoming jet creates considerable eddies in the head end of the tank forming an active recirculation zone. The added dye was completely mixed in the

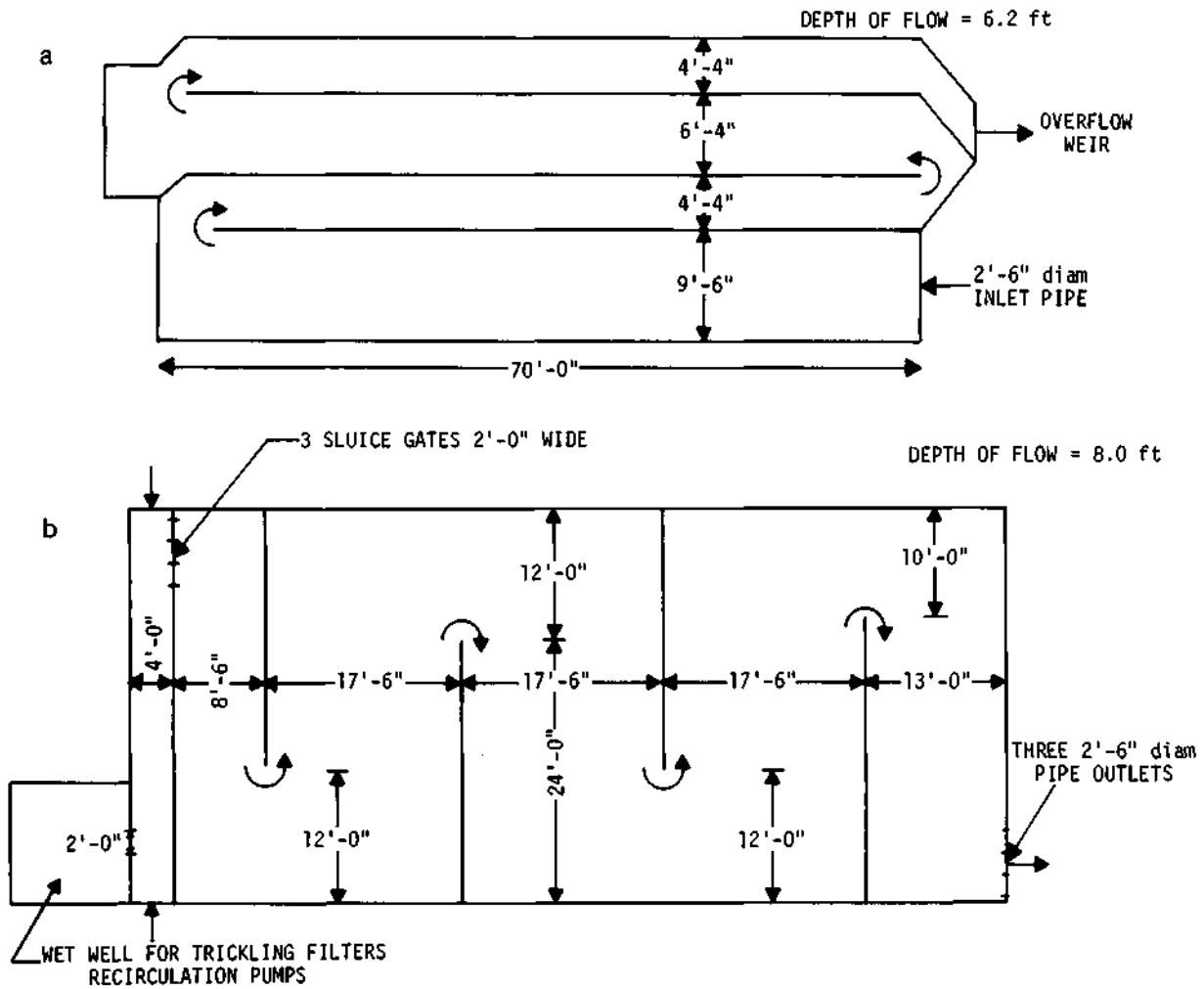

Figure 2. Chlorine contact tanks for activated sludge plant (a) and trickling filter plant (b), BNSD

Table 1. Hydraulic Flow-Through Characteristics of Chlorine Contact Tank for Activated Sludge Plant, BNSD

	Time (minutes) for runs at given flow rates (mgd)					
	2.43		2.84		2.88	
Theoretical de- tention time	49.3	49.3	49.3	42.2	41.6	41.6
t_i	16.0	16.0	16.0	15.0	17.0	16.0
t_{10}	18.0	18.0	18.0	19.0	19.5	20.1
t_{90}	42.5	42.5	39.5	39.5	40.5	42.5
t_p	30.0	30.0	25.0	25.0	25.0	25.0
t_g	31.4	31.4	29.4	29.9	30.6	31.8
t_m	27.5	27.5	26.0	23.0	26.5	27.5
Morril index*	2.4	2.4	2.2	2.1	2.1	2.1
Dye recovery (%)	79.9	86.2	77.6	89.5	75.7	90.5

*Morril index is dimensionless

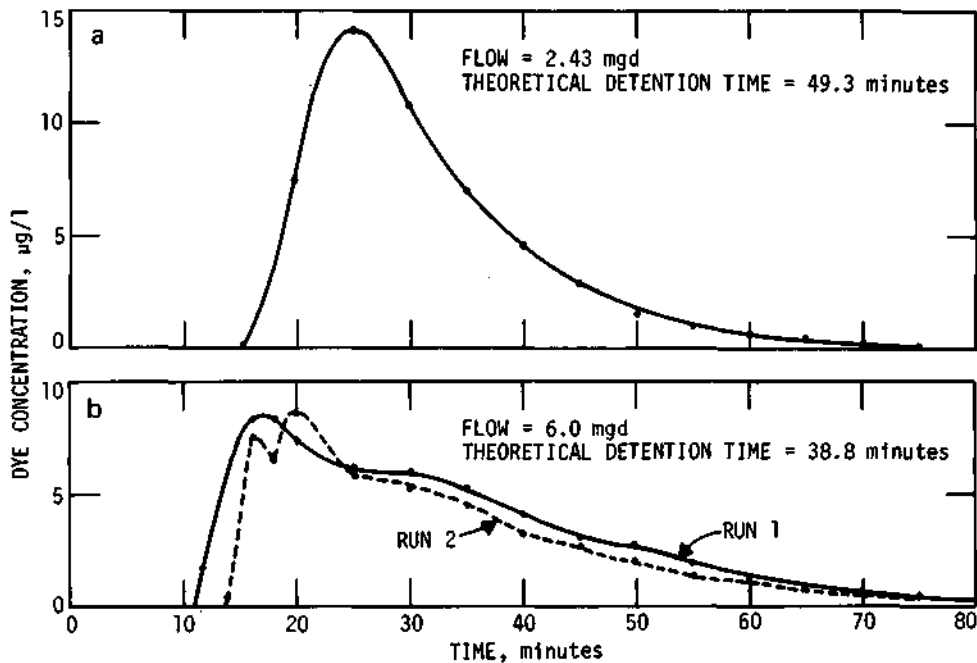

Figure 3. Flow-through curve for contact tanks of activated sludge plant (a) and trickling filter plant (b), BNSD

first bay, and all the dye was flushed out of the system within a period of about 75 minutes. The time was much less than twice the theoretical detention period.

The Morrill index values vary significantly from the ideal value of 1.0. The hydraulic flow-through characteristics could be improved considerably by providing baffles at the inlet end to suppress the kinetic energy of the incoming jet and thus distribute the flow more uniformly across the cross section of the tank. The values of other parameters are given in table 1.

The operation and performance characteristics of the tank are presented in table 2. The pH of the waste water seems to be stable at 7.5 during the period of this investigation. From the data on suspended matter, it can be seen that solids do settle in the tank. However, no samples of settled solids were obtained because the tank bottom is cleaned periodically. On occasion, rising bubbles, presumably gases of putrefaction, were observed in the tank. Under normal operating conditions the quality of effluent with respect to filterable solids seems to be excellent.

From the data for the rate of chlorine application and the residual chlorine at the influent end of the tank, the immediate chlorine demand seems to vary from 0.7 to 2.6 mg/l. The trend seems to be that the higher the rate of application of chlorine, the higher the immediate chlorine demand. The reason for this is not known at this time. The residual chlorine concentrations at the effluent end of the contact tank were high and were only 0.1 to 0.4 mg/l less than at the influent end. Once the immediate demand is satisfied, utilization of chlorine in the contact tank seems to be minimal. The efficiencies of bacterial kill were high.

A study was carried out to determine the desirable rate of application of chlorine, consistent with the effluent bacterial quality. The results are presented in table 3. The immediate demands varied from 0.6 to 1.0 mg/l in these analyses. The difference in the chlorine concentrations at the influent and effluent ends of the tank was between 0.1 and 0.4 mg/l except in one instance. Although the bactericidal effect of chlorine is a complex phenomenon governed by such factors as organic and ammonia concentrations, contact time, pH, and temperature, the fecal coliform counts decreased even

Table 2. Performance Characteristics of Contact Tank for Activated Sludge Plant, BNSD

	2.43 mgd						2.84 mgd		2.88 mgd			
	I	E	I	E	I	E	I	E	I	E	I	E
Temperature (°C)	16	16	15	15	15	15	19	19	19	19	18	18
pH	7.4	7.4	7.5	7.5	7.5	7.5	7.5	7.5	7.5	7.5	7.5	7.5
Suspended matter (mg/l)	5	3	7	6	5	1	3	8	6	9	14	5
Chlorine dosage (mg/l)	3.8		4.4		4.1		3.0		2.8		2.8	
Residual chlorine (mg/l)	2.1	1.7	2.6	2.4	1.5	1.3	1.6	1.5	2.1	1.7	1.9	1.6
Total coliform (per 100 ml)	780,000	470	1,200,000	1400	160,000	810	850,000	1300	280,000	200	500,000	1000
Percent kill		99.94		99.89		99.50		99.85		99.93		99.80
Fecal coliform (per 100 ml)	180,000	110	240,000	130		25	100,000	220	42,000	70	59,000	150
Percent kill		99.94		99.95				99.78		99.84		99.74

I = Influent
E = Effluent

Table 3. Relationship of Chlorine Concentrations and Coliform Densities in the Contact Tank for Activated Sludge Plant, BNSD

(Flow rate 2.88 mgd)

Chlorine dosage (mg/l)	Temp. (°C)	pH		Residual chlorine (mg/l)		Total coliform (counts/100 ml)		Kill (%)	Fecal coliform (counts/100 ml)		Kill (%)
		I	E	I	E	I	E		I	E	
2.8	18	7.5	7.5	1.9	1.5	500,000	900	99.82	60,000	320	99.47
2.5		7.3	7.3	1.9	1.0		2,400			200	
2.3	20	7.1	7.1	1.5	1.1	360,000	2,200	99.40	80,000	333	99.58
2.0	21	7.5	7.5	1.0	0.7	1,900,000	3,400	99.82	130,000	230	99.82
1.6	23	7.4	7.4	0.8	0.7	670,000	2,400	99.64	52,000	100	99.81

I = Influent
E = Effluent

though the rate of application of chlorine was progressively decreased. This is probably caused by the observed increase in temperature from about 18 to 23 C because all other factors were more or less similar.

Results for Trickling Filter Plant Contact Unit. The time-tracer concentration curves for the chlorine contact tank for the trickling filter plant are shown in figure 3b. All three dye tests, conducted at a flow rate of 6 mgd in this tank, exhibited different flow-through characteristics. Figure 3b shows the results for two dye tests. Obtaining reproducible results was difficult because of the pulsating flow caused by the alternating cycles of resting and dosing of the filter beds.

As in the contact tank for the activated sludge plant, the dye was completely dispersed in the first bay, although during a longer time interval. The dye cloud moved in a narrow serpentine band through the consecutive bays, indicating a significant amount of dead space in the corners of each of the bays, except the first, and on the leeward side of the baffles. When the leading edge of the dye cloud reached the exit end, the dye could still be seen in the first bay. In fact, a serpentine dye pattern could be seen throughout the entire length of the tank.

The results of the evaluation of flow-through curves are presented in table 4. Although the contact tank has a theoretical detention time of about 39 minutes, 50 percent of the flow leaves the tank in about 28 minutes. A portion of the flow leaves the tank in about 11 minutes, much less than the desirable contact time of 15 to 25 minutes. The Morril index values are high and indicate a highly dispersed flow pattern. Because the baffles are widely spaced, this contact tank is farther from the ideal situation of plug flow than was the tank for the activated sludge plant.

The performance characteristics of the contact tank are shown in table 5. The pH varied from 6.7 to 7.4. The suspended matter data are not consistent in showing that solids settle in the tank, yet significant amounts of solids were collected from the tank bottom. The settled solids samples were dark, well stabilized, and emitted a musty odor. Samples obtained on three different occasions from three different locations in the tank had volatile fractions (by dry weight) of 45.1, 44.8, and 44.8 percent. The volatile fraction of final settling tank solids is likely to be in the range of 90 to 95 percent. This indicates the extent of mineralization caused by anaerobic decomposition and the presence of an oxidant creating an additional demand for chlorine. It is believed that a greater economy in chlorine application can be achieved by minimizing the deposition of suspended matter.

Consistent data were not obtained for immediate chlorine demand because of a lack of complete mixing at the head end of the tank. The rate of application of chlorine was adequate to provide levels of residual chlorine concentrations in the effluent that meet existing state standards. Fecal coliform counts, however, were higher than those required by these standards.

Generally, the performance of the chlorine contact tank for the trickling filter plant seems inferior to that for the activated sludge plant. Presumably this is caused by a combination of factors but is principally related to poorer hydraulic performance. It is believed that the hydraulic performance of the chlorine contact tank for the trickling filter plant can be greatly improved by mildly agitating the contents of the contact tank with compressed air. With this modification, the problem of solids sedimentation and subsequent mineralization in the tank can be eliminated or at least minimized. Mixing the contents of the tank should improve the overall performance characteristics of the tank.

Aurora Sanitary District (ASD)

Two different and separate treatment processes are used for treating waste water at Aurora. The contact stabilization plant has a design capacity of 22 mgd, and the fixed nozzle trickling filter plant has a design capacity of 10 mgd. The effluents from these two processes are combined just ahead of the chlorine mixing chamber and the chlorine solution is administered at the inlet to the mixing chamber. The general layout of the treatment facilities is shown in figure 4. The facilities at this site provided a unique opportunity for investigating contact tanks provided with mechanical flash mixing of chlorine and automated sludge collectors. Details of the mixing and contact tanks are shown in figure 5.

The tracer dye was added at the head of the mixing chamber. There was a time lag of less than 30 seconds between the time the dye was added and the initial appearance of the dye in the tank. Samples were obtained at frequent intervals at the outlet end of the contact basin for defining the time-tracer concentration relationships. Simultaneously with the dye test, samples were obtained from the inlet and outlet ends of the contact tank for pH and temperature measurements, residual chlorine determinations, and bacteriological analyses. The pH, temperature, and total residual chlorine of the samples were determined immediately.

Results for ASD Contact Unit. The hydraulic flow-through characteristics were observed at three different flow rates, 12.4, 13.0, and 14.3 mgd. The time-concentration curves for the

Table 4. Hydraulic Flow-Through Characteristics of Chlorine Contact Tank for Tricking Filter Plant, BNSD

	Time (minutes) for tests at 6.0 mgd		
	Test 1	Test 2	Test 3
Theoretical detention time	38.8	38.8	38.8
t_i	10.5	13.0	11.0
t_{10}	16.0	17.0	14.0
t_{90}	52.5	52.5	47.5
t_p	18.0	20.0	25.0
t_g	33.8	34.3	31.6
t_m	27.5	28.5	26.5
Morril index*	3.3	3.1	3.4
Dye recovery (%)	93.0	84.1	83.7

*Morril index is dimensionless

Table 5. Performance Characteristics of Contact Tank for Tricking Filter Plant, BNSD

	Test 1		Test 2		Test 3		Test 4	
	I	E	I	E	I	E	I	E
Temperature (°C)	19	19	19	19	18.5	18.5	18	17.5
pH	7.3	6.9	7.3	7.3	6.7	7.3	7.4	7.2
Suspended matter (mg/l)	38	26			21	22		
Chlorine dosage (mg/l)	3.4		3.4		4.3		4.3	
Residual chlorine (mg/l)	1.7	1.7	0.7	0.9	4.8	1.1	0.6	0.8
Total coliform (per 100 ml)	4,700,000	2,200	4,000,000	14,000	5,200,000	5,100	5,900,000	4,200
Percent kill		99.95		99.65		99.90		99.95
Fecal coliform (per 100 ml)	760,000	460	840,000	3,600	600,000	1,500	410,000	670
Percent kill		99.94		99.57		99.75		99.84

I = Influent
E = Effluent

three different flow rates are shown in figure 6. No stable pattern for the flow-through characteristics can be discerned from the configurations of these curves. The time of passage for peak concentrations is shifting, and with a flow of 14.3 mgd, two prominent peak concentrations are apparent.

The theoretical detention times (volume displacement times) of the contact tank at observed rates of flow are 57.4, 54.9, and 50.2 minutes, respectively. The tracer flow-through curves were evaluated by central tendency parameters and the results are shown in table 6.

Though the configuration of the tank is narrow and long (width to length ratio of 1:4.63) and thus conducive to plug flow with minimum axial dispersion, the first appearance of the tracer at the outlet end was 15 minutes as against a theoretical detention time of 50.2 to 57.4 minutes. The probable reason for this difference involves the inlet design. The feeder conduit is located centrally with respect to the 10 inlet ports, and the momentum of velocity of flow in the conduit results in a greater part of the flow going through the middle two or four inlet ports. Also, since the invert of the inlet ports is 4.5 feet above the bottom of the tank, the initial momentum carries the flow to the middle of the tank in 3 to 5 minutes. When the outlet weir level and the invert level of the inlet ports are considered with

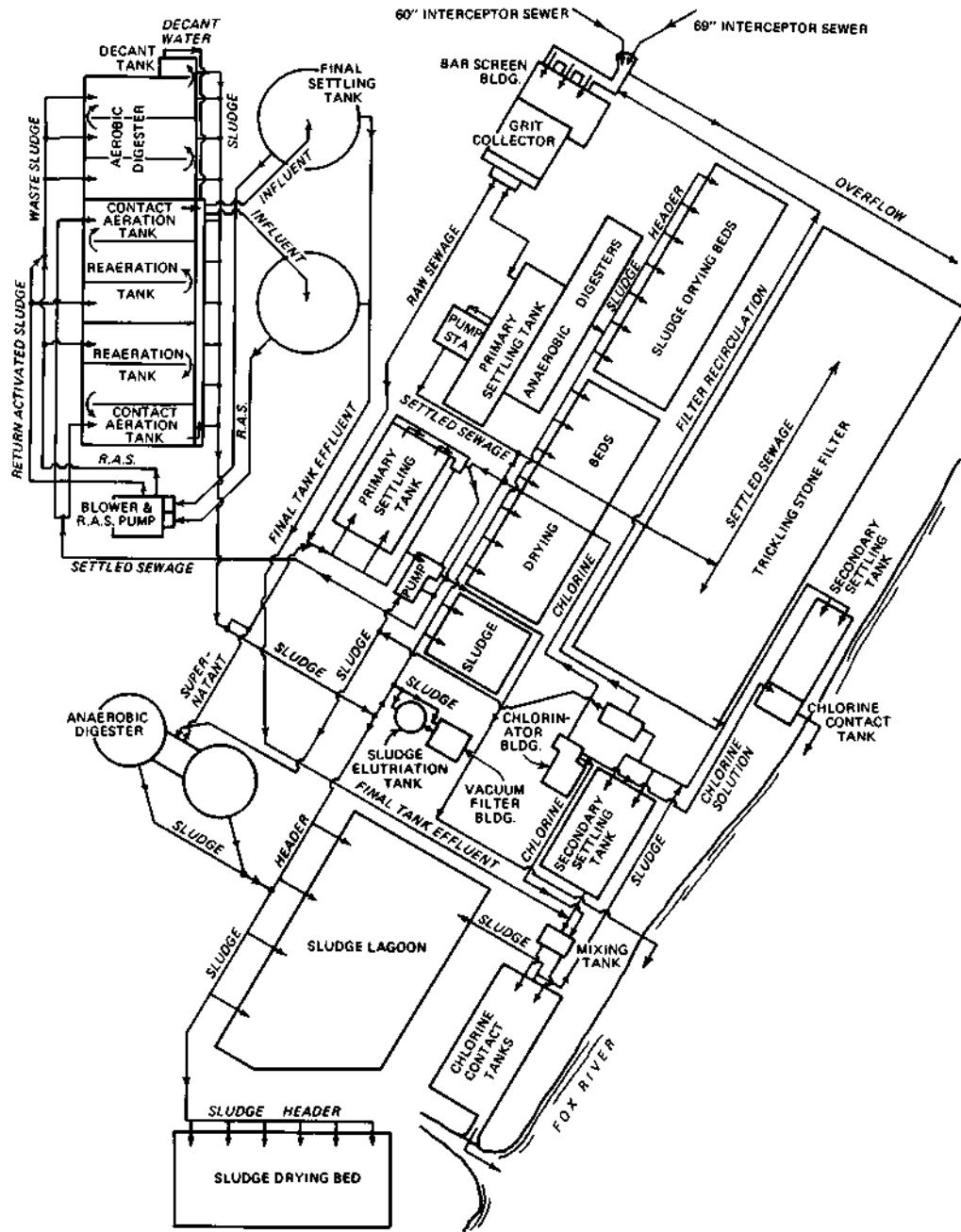

Figure 4. Flow diagram of water pollution control plant, ASD

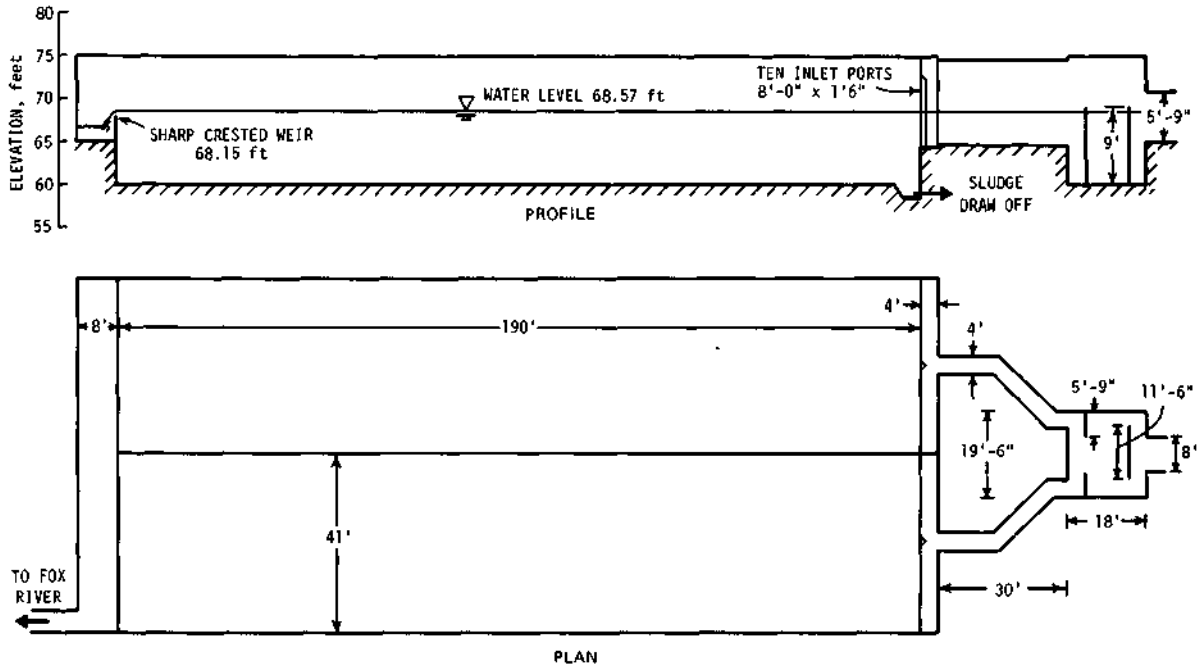

Figure 5. Chlorine contact tanks and mixing chamber, ASD

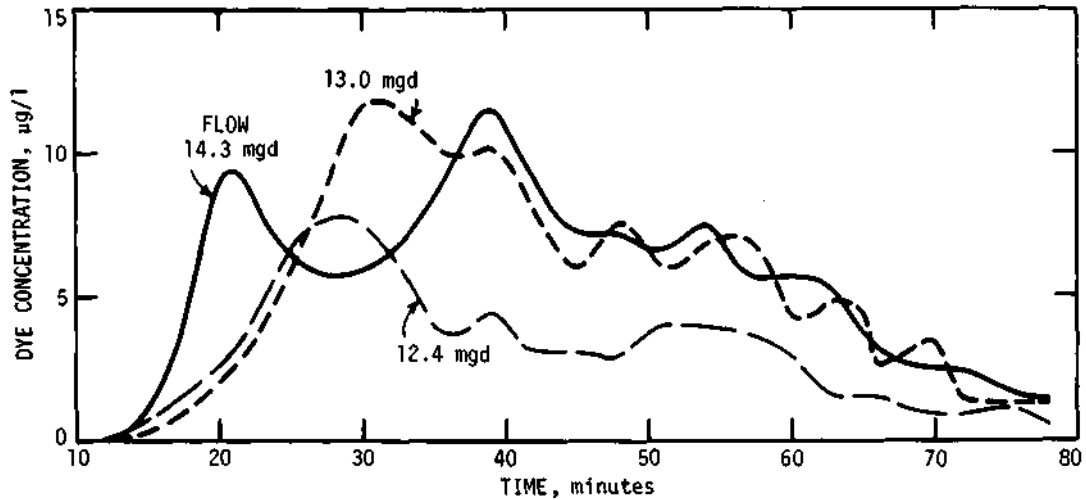

Figure 6. Flow-through curves for contact tank, ASD

respect to the bottom of the contact tank, a significant amount of dead space in the inlet and the outlet zones can be visualized. This is borne out by the fact that a portion of the incoming flow leaves the contact tank in 15 minutes. The Morrill index values are significantly at variance with the ideal value of 1.0, and the hydraulic flow-through characteristics are found to be far from ideal, primarily because of the inlet flow conditions.

The operational and performance characteristics of the contact tank are presented in table 7. The pH of the waste effluent varied from 7.1 to 7.7 during the period of this investigation. Once the immediate chlorine demand was satisfied, there was very little or no change in the total chlorine residual con-

Table 6. Hydraulic Flow-Through Characteristics of Chlorine Contact Tank, ASD

	Time (minutes) at given flow rates (mgd)		
	Test 1	Test 2	Test 3
	12.4	13.0	14.3
Theoretical detention time	57.4	54.9	50.2
t_i	15.0	15.0	15.0
t_{10}	21.5	26.0	20.5
t_{90}	58.5	61.5	61.5
t_p	28.5	31.0	39.0
t_g	39.9	43.3	42.3
t_m	35.0	39.5	39.8
Morril index*	2.7	2.4	3.0
Dye recovery (%)	69.4	85.8	101.0

*Morril index is dimensionless

Table 7. Performance Characteristics of Chlorine Contact Tank, ASD

	Test 1		Test 2		Test 3		Test 4		Test 5	
	I	E	I	E	I	E	I	E	I	E
Flow (mgd)	12.4	12.4	12.4	12.4	13.0	13.0	13.0	13.0	14.3	14.3
Temperature (°C)	10.0	10.0			9.5	9.5			9.5	9.5
pH	7.1	7.1			7.7	7.5			7.4	7.3
Chlorine dosage (mg/l)	3.4				4.2				3.8	
Residual chlorine (mg/l)	1.4	1.4			1.1	1.0			1.0	0.9
Total coliform	3,400,000	390	6,300,000	540	7,700,000	93	5,900,000	150		
Percent kill		99.989		99.991		99.999		99.997		
Fecal coliform	140,000	4	130,000	28	150,000	0	140,000	0		
Percent kill		99.997		99.978		100.0		100.0		

I = Influent
E = Effluent

centrations between the samples obtained at the inlet and outlet ends of the contact tank. Since the bottom deposits are removed every day, there were no visible signs of rising gas bubbles. The efficiencies of total and fecal coliform reductions were very high, and the effluent from the plant met the Illinois Pollution Control Board requirement for fecal coliform counts of 400 per 100 ml or less in waste effluents.

Pekin Waste Treatment Plant (PWTP)

The twin secondary treatment units of the Pekin plant employ a high rate contact stabilization process with a design flow of 1.88 mgd for each unit. The effluent from each unit is chlorinated separately before being discharged to the receiving stream. The general layout of the waste treatment plant is shown in figure 7a.

The chlorine contact tank for each of the secondary treatment units is in the form of a truncated segment of the sector of a circle, the details of which are shown in figure 7b. Each of the contact chambers is provided with three Spargers for purposes of air agitation. The Pekin contact units provided a unique opportunity for investigating the chlorination aspects of treated waste water with and without air agitation.

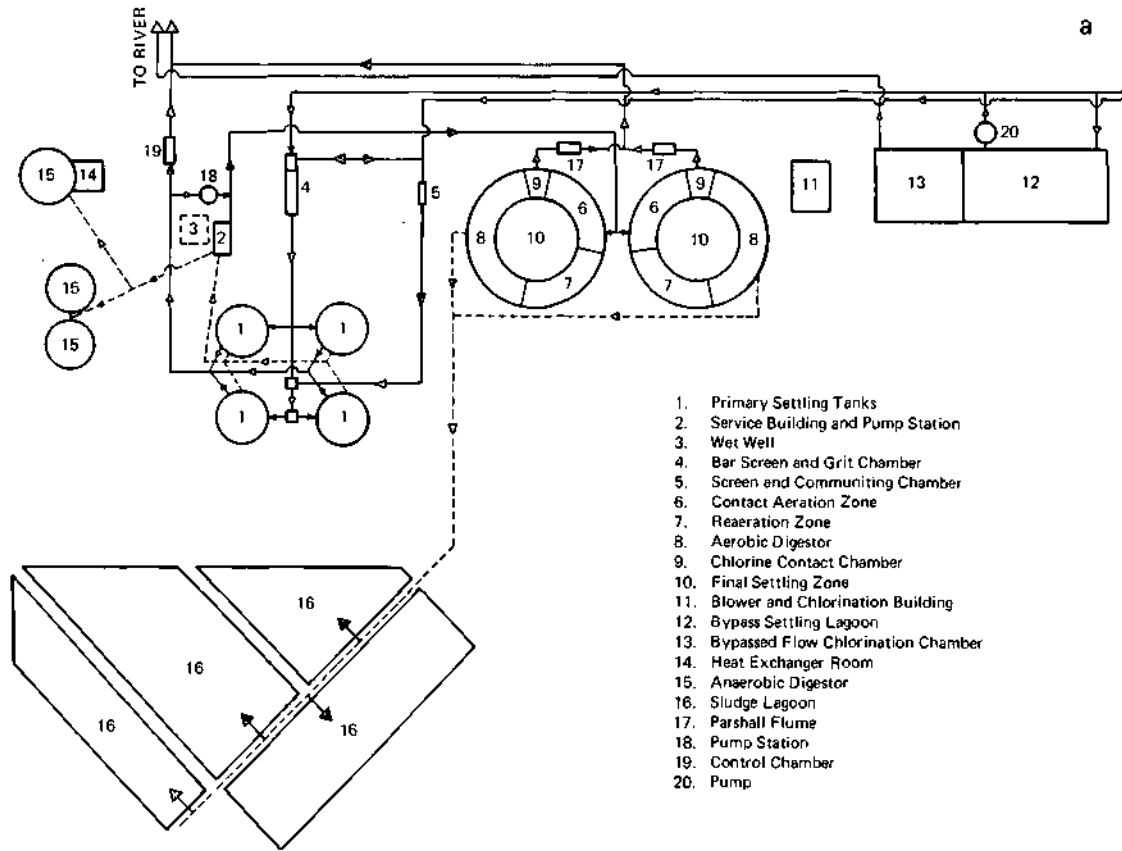

1. Primary Settling Tanks
2. Service Building and Pump Station
3. Wet Well
4. Bar Screen and Grit Chamber
5. Screen and Comminuting Chamber
6. Contact Aeration Zone
7. Reaeration Zone
8. Aerobic Digester
9. Chlorine Contact Chamber
10. Final Settling Zone
11. Blower and Chlorination Building
12. Bypass Settling Lagoon
13. Bypassed Flow Chlorination Chamber
14. Heat Exchanger Room
15. Anaerobic Digester
16. Sludge Lagoon
17. Parshall Flume
18. Pump Station
19. Control Chamber
20. Pump

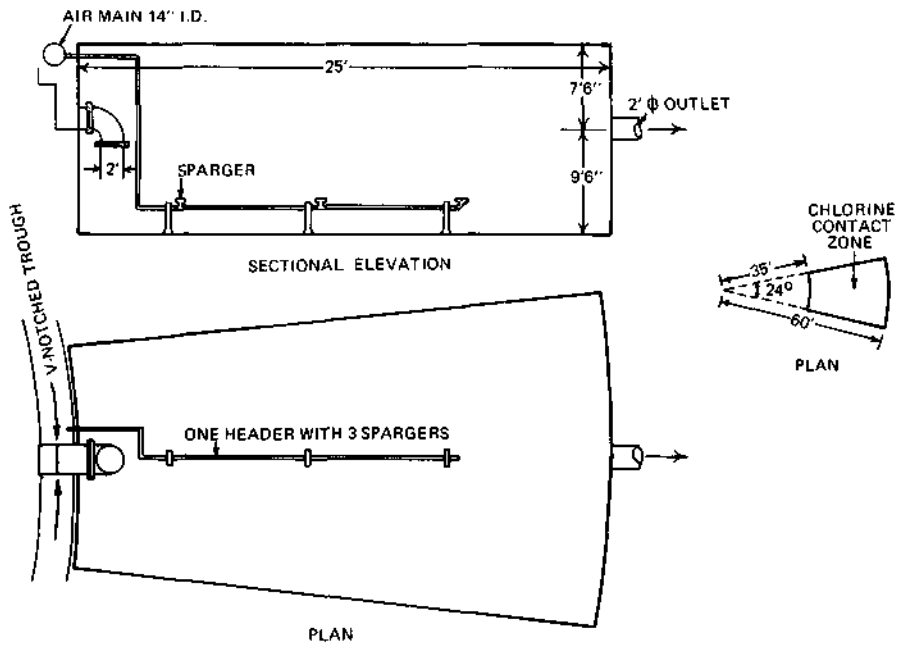

Figure 7. Flow diagram of water pollution control plant (a) and details of chlorine contact tank (b), PWTP

The hydraulic flow-through characteristics of one of the two contact tanks were investigated by adding rhodamine-B dye at the outlet end of the circular launder of the secondary settling tank at flow rates ranging from 1.3 to 2.3 mgd. Samples were obtained at frequent intervals to define the time-tracer concentration relationship. Samples were also obtained from the inlet and outlet ends of the chlorine contact tank for pH, temperature, and residual chlorine determinations and for bacteriological analyses. There are no means of regulating the flow through either of the two units so as to maintain a reasonably constant flow in one of them. Consequently natural variations in flow during the dye tests were inevitable. Average flow rates were used in computing the theoretical detention periods.

Results for Pekin Contact Unit without Air Agitation. Figure 8a shows the time-tracer concentration curves for the contact chamber without air agitation. The dye arrived at the outlet end of the contact tank in less than a minute even though the theoretical detention time was anywhere between 21.0 and 37.5 minutes. The inlet to the contact chamber from the outlet end of the settling tank's circular launder is in the form of a 24-inch diameter pipe terminating in a 90° bend downward. The high degree of turbulence from the inflow causes the contents of the tank to be completely mixed. The time-tracer concentration curves indicate that the injected dye takes about 5 to 10 minutes to be completely mixed depending upon the rate of flow through the tank. The higher the flow rate, the more rapid the mixing process.

Table 8 shows the results of analyses of the dye tests without agitation. The Morril index for the Pekin contact tank was extremely high, ranging from 9.9 to 11.8, in comparison with values in the order of 3 and 2 for the contact tanks at Bloomington and Aurora. The conditions of ideal plug flow could not be realized because of the highly turbulent conditions of the inflow to the tank.

Chemical and bacterial performance characteristics of the chlorine tank without air agitation are shown in table 9. The dissolved oxygen at the outlet of the contact tank was found to be high even though the dissolved oxygen content of the settling tank effluent in the collecting launder was 0 or 0.1 mg/l. This is partly due to the air entrapment in the waste flow just ahead of the chlorine contact tank and the high degree of turbulence in the contact tank.

The bacterial analyses carried out simultaneously with the dye tests without air agitation were not quite successful. The dilutions and sample size used in the millipore technique resulted in growths of bacterial colonies that were too numerous to count. Earlier experience with activated sludge treatment plant effluent indicated that a chlorine dosage rate of 2 to 3 mg/l was adequate to achieve the effluent bacterial quality stipulated by the Illinois Pollution Control Board. As will be discussed later, a dosage rate of 2.8 mg/l for the Pekin waste treatment plant secondary settling tank effluent was adequate in a batch reactor with 15 minutes contact period.

Results for Pekin Contact Unit with Air Agitation. The flow-through characteristics of the contact chamber with air agitation are shown in figure 8b at flow rates ranging again from 1.3 to 2.3 mgd. The rate of air supply to the contact tank alone could not be measured. The first arrival of tracer at the outlet end was found to be slightly retarded. Otherwise these flow-through curves appear to be similar to the ones without air agitation.

Results of analysis of the dye tests with air agitation of the contents of the contact tank are shown in table 10. Morril index varied from 9.1 to 12.9 which was comparable with the results obtained without air agitation. The extent of turbulence in the contact tank without air agitation is so high that additional air agitation did not affect the hydraulic flow-through characteristics.

The chemical and bacteriological performance characteristics of the contact tank under air agitated conditions are shown in table 11. The dissolved oxygen in the effluent appears to be of the same order of magnitude as that of the contact tank without air. The chlorine dosage rate was maintained between 3.1 and 5.5 mg/l. The residual chlorine of the effluent samples was relatively high, from 1.6 to 3.6 mg/l. However the fecal coliform count, which is the controlling parameter, was invariably found to be higher than the desired limit. Only two of the eight samples met the Illinois

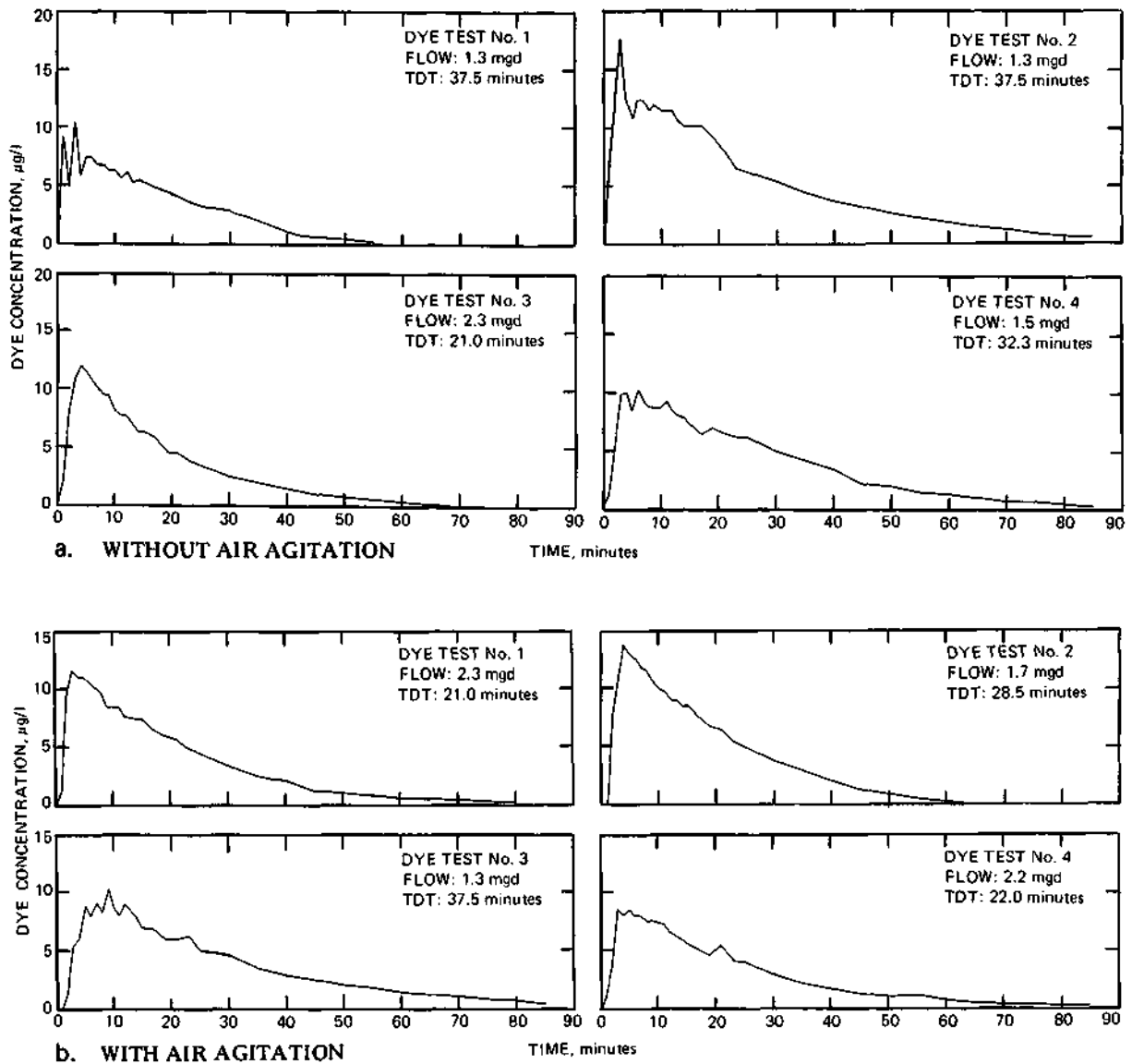

Figure 8. Flow-through curves for contact tank without air agitation (a) and with air agitation (b), PWTP

Pollution Control Board standards for water effluent bacterial quality standards, and these occurred when the chlorine application rate was high, 5.5 mg/l.

Batch Reactor Experiments. Since it was impossible to attain the ideal flow conditions in the contact tank, the importance of the residence time distribution of the waste water flow through the contact tank was investigated. Experiments to delineate the extent of bacterial kill in a batch reactor at varying chlorine dosage rates with a 15-minute contact period were carried out with the use of secondary settling tank effluent of the Pekin plant. This contact time was significantly less than the theoretical detention time in the contact tank at the highest observed flow rate in the treatment plant. The batch reactor studies were carried out with secondary effluents collected on six different days.

Table 8. Hydraulic Flow-Through Characteristics of Chlorine Contact Tank without Air Agitation, PWTP

	Time (minutes) at given flow rates (mgd)			
	Test 1	Test 2	Test 3	Test 4
	1.3	1.3	2.3	1.5
Theoretical detention time	37.5	37.5	21.0	32.0
t_i	<1.0	2.0	<1.0	<1.0
t_{10}	2.9	4.8	3.6	4.7
t_{90}	34.3	54.9	35.5	48.1
t_g	16.7	24.8	17.2	25.2
t_m	14.0	20.3	12.7	20.0
t_p	3.0	3.0	4.0	6.0
Morril index*	11.8	11.4	9.9	10.2

*Morril index is dimensionless

Table 9. Performance Characteristics of Chlorine Contact Tank without Air Agitation, PWTP

	Test 1		Test 2		Test 3		Test 4	
	I	E	I	E	I	E	I	E
Flow (mgd)	1.3	1.3	1.3	1.3	2.1	2.1	1.5	1.5
Temperature ($^{\circ}$ C)	20.4	20.4	20.2	20.2	22.3	22.0	21.8	21.8
pH	6.8	6.8	6.8	6.8	6.8	6.8	6.8	6.8
Chlorine dosage (mg/l)	1.8		1.8		2.1		4.8	
<i>Samples at beginning of dye tests</i>								
Dissolved oxygen (mg/l)		5.3		4.6		5.2		5.6
Residual chlorine (mg/l)	2.8	1.0	1.8	0.8	1.1		2.1	2.7
Total coliform	800,000	32,000	20,000,000	$\geq 10,000$		200,000		
Percent kill		96.00						
Fecal coliform	120,000	1,000		>1,000		10,800		
Percent kill		98.80						
<i>Samples at the end of dye tests</i>								
Dissolved oxygen (mg/l)		5.6		4.9		3.3		6.0
Residual chlorine (mg/l)		1.1		0.8		1.0		1.9
Total coliform	870,000	44,000		$\geq 10,000$	400,000	25,000		
Percent kill		95.50				93.75		
Fecal coliform	92,000	1,500		>1,000	80,000	1,200		
Percent kill		98.37				98.50		

I = Influent
E = Effluent

The results of the batch reactor experiments are shown in table 12. The residual chlorine at the 2.8 mg/l dosage rate, after the contact period, was found to vary from 0.50 to 1.95 mg/l. The amount of chlorine utilized in the chlorination process thus varied from 1.05 to 2.3 mg/l. The bacterial quality of the chlorinated sample at the end of the contact period was found to meet the state regulations with one exception. In test 1, the standards were met at a dosage rate of 2.0 mg/l but not at the 2.8 mg/l dosage.

As previously discussed, in the field contact tank, satisfactory bacterial quality could not be attained at a dosage rate of 4 to 5 mg/l. The results of the batch reactor experiments would indicate that this is mainly due to the lack of sufficient residence time of the waste flow in the contact chamber, even though the theoretical detention time is not less than 21.0 minutes.

Table 10. Hydraulic Flow-Through Characteristics of Chlorine Contact Tank under Air Agitated Conditions, PWTP

	Time (minutes) at given flow rates (mgd)			
	Test 1	Test 2	Test 3	Test 4
	2.3	1.7	1.3	2.2
Theoretical detention time	21.0	28.5	37.5	22.0
t_1	1.0	2.0	2.0	1.0
t_{10}	3.3	3.7	6.0	4.0
t_{90}	42.5	34.3	54.5	44.8
t_g	20.9	17.9	27.1	21.7
t_m	15.0	15.0	21.0	16.0
t_p	3.0	4.1	9.0	4.0
Morril index*	12.9	9.2	9.1	11.2

*Morril index is dimensionless

Table 11. Performance Characteristics of Chlorine Contact Tank under Air Agitated Conditions, PWTP

	Test 1		Test 2		Test 3		Test 4	
	I	E	I	E	I	E	I	E
Flow (mgd)	2.3	2.3	1.7	1.7	1.3	1.3	2.2	2.2
Temperature (°C)	22.0	22.0	23.6	23.6	23.1	23.1	22.8	22.8
pH	6.8	6.8	6.8	6.8	6.8	6.8	6.8	6.8
Chlorine dosage (mg/l)	3.1		4.2		5.5		3.8	
<i>Samples at beginning of dye tests</i>								
Dissolved oxygen (mg/l)		4.7		5.2				5.8
Residual chlorine (mg/l)			3.1	1.6	4.1	3.6	3.6	3.6
Total coliform	2,800,000	86,000	2,900,000		1,100,000	900	550,000	10,000
Percent kill		96.93				99.92		98.18
Fecal coliform	950,000	8,000	560,000	800	210,000	170	120,000	420
Percent kill		99.16		99.86		99.92		99.65
<i>Samples at the end of dye tests</i>								
Dissolved oxygen (mg/l)		5.4		5.1				
Residual chlorine (mg/l)				1.9		2.7		1.7
Total coliform	3,400,000	145,000	3,100,000	28,000	1,600,000	2,600	530,000	30,000
Percent kill		95.73		99.10		99.84		94.34
Fecal coliform	760,000	>10,000	500,000	1,900	210,000	300	190,000	1,760
Percent kill				99.62		99.86		99.17

I = Influent
E = Effluent

Discussion

The bacterial quality of the effluent from the Aurora waste treatment plant was excellent. This may be because the waste stream is well mixed with the chlorine solution before it enters the contact chambers. A significant factor also seems to be the frequent removal of bottom deposits which if allowed to remain for a sufficiently long period would putrefy and exert undue chlorine demand.

The performance characteristics of the chlorine contact tank for the activated sludge plant at Bloomington (BNSD), presented in table 2, appear to be comparable to those for the chlorine contact tanks at Aurora (ASD). The settled solids in the BNSD contact tank are flushed out less frequently

Table 12. Pekin Secondary Effluent Chlorination with 15 Minutes Contact in a Batch Reactor, Quiescent Conditions

Chlorine dosage (mg/l)	Residual chlorine (mg/l)	Total coliform (counts/100 ml)	Removal efficiency (%)	Fecal coliform (counts/100 ml)	Removal efficiency (%)
<i>Experiment 1</i>					
0	0	7,360,000		130,000	
1.20	0.65	180,000	97.53	4,000	96.93
2.00	1.45	41,000	99.44	220	99.83
2.80	1.95	9,000	99.88	600	99.54
<i>Experiment 2</i>					
0	0	500,000		9,000	
1.20	0.35	49,000	90.20	900	90.00
2.00	0.85	13,000	97.40	150	98.33
2.80	1.30	8,000	98.40	45	99.50
<i>Experiment 3</i>					
0	0			70,000	
1.50	0.55			1,000	98.57
2.30	1.60			140	99.80
2.80	1.80			30	99.06
<i>Experiment 4</i>					
0	0	620,000		66,000	
1.20	0.35	87,000	85.97	790	98.80
2.00	0.75	17,000	97.26	100	99.85
2.80	1.40	3,700	99.40	280	99.58
<i>Experiment 5</i>					
0	0	800,000		69,000	
1.20	0.30	130,000	83.75	7,800	88.70
2.00	0.50	7,400	99.08	600	99.13
2.80	0.75	2,100	99.74	170	99.75
<i>Experiment 6</i>					
0	0	2,700,000		180,000	
1.20	0.20	48,000	98.22	2,400	98.67
2.00	0.40	8,000	99.70	950	99.47
2.80	0.50	3,500	99.87	330	99.82

(once in 2 to 4 weeks) than they are at ASD. On several occasions rising bubbles, presumably gases of putrefaction, were noticed in the BNSD contact tank. Rates of application of chlorine for these contact tanks and the immediate chlorine demands in these two cases are similar in magnitude. However, the rates of utilization of chlorine residual appear to be higher in the contact tank for BNSD. This could be attributed, partially at least, to the existence of putrefying bottom deposits. Though the chlorine solution is administered by a perforated pipe diffuser at the head end of the contact tank at BNSD, the turbulent condition in the first bay of the multipass baffled unit provides complete mixing of chlorine solution with the waste stream. Contrary to expectations, the bacterial quality of the effluent from this contact tank was not as good as that for the ASD contact tank. The temperature of waste flow was much higher and the initial bacterial counts were several orders of magnitude less in the BNSD tank than in the ASD tank at the time of observation.

The hydraulic flow-through characteristics of the contact tank for the activated sludge treatment plant at BNSD (table 1) are strikingly similar to those for the ASD contact tank. These tanks are grossly oversized, with the result that, in spite of severe short circuiting problems, they provide a minimum contact time of about 15 minutes. Generally, absence of putrefying solids point to the more efficient and economic operation of chlorine contact tanks.

Performance characteristics and hydraulic flow-through characteristics of the contact tank for the trickling filter unit at BNSD are tabulated in tables 5 and 4, respectively. Unlike the contact tank for the activated sludge plant at the same location, bottom deposits are removed only once a year. Consequently, there were several locations in the tank where rising gas bubbles could be seen most of the time. Though the rate of application of chlorine is comparable to the other two cases, the bacterial quality of the effluent from this tank was much inferior and did not meet Illinois Pollution Control Board bacterial standards. The tank provided a minimum contact period of about 11 minutes as against a theoretical detention time of 38.8 minutes. Inadequate initial mixing of chlorine solution with waste flow, hydraulic short circuiting, and the presence of putrefying bottom deposits are the important factors in the inadequate overall performance of this unit.

Although the data are perhaps too meager for complete proof, these studies indicate that in addition to the need for thorough initial mixing of any disinfectant with the waste stream, there is a definite need for either the frequent removal of settled organic solids from the contact tanks before these solids begin to putrefy or the use of appurtenances to minimize settling of organic solids in the contact units.

The hydraulic flow-through characteristics of the contact tank at Pekin (PWTP) were found to be far from ideal plug flow conditions. Soon after the complete mixing of the dye in the tank, the tracer curves resemble an exponential decay pattern attributable to dilution in a well mixed reactor. Figure 9 characterizes the time-tracer concentration relationship at the outlet end of an ideal completely mixed reactor resulting from a slug tracer dosage that is instantaneously well mixed. The theoretical concentration, C , of the tracer at the outlet at any time, t , is given by the equation

$$C = C_0 e^{-t/T}$$

where C_0 is the initial concentration of the tracer in the reactor (at time $t = 0$) and T is the theoretical detention time. As shown in figure 9, the flow pattern of observed dye concentrations at the outlet end of the contact tank (without air mixing) resembles that of a completely mixed reactor.

Before commencing the dye tests in the PWTP contact tank without air agitation, the air supply to the tank was shut off for about a month to investigate the effects of settled solids. In this PWTP contact tank, no trace of settled solids, even at the corners of the contact chamber, could be found. This is primarily because of the intense degree of mixing within the contact tank. In contrast, in the chlorine contact tank for the BNSD activated sludge plant, solids accumulation and subsequent putrefaction with rising gas bubbles were noticed within 7 to 10 days. An interface sampler was used in the attempt to collect settled solids in the PWTP tank. This sampler was used successfully for obtaining samples of settled solids in the contact tank for the BNSD trickling filter plant.

On the basis of the batch reactor studies with Pekin treatment plant effluent, it can be concluded that the residence time distribution of the flow through a contact tank is an important factor. Design of contact tanks based on volume displacement criteria alone does not produce the desired results. Careful consideration of inlet and outlet structures of the tank, initial rapid and complete mixing of chlorine solution in the waste flow, minimum desired residence time for bacterial kill, solids removal before putrefaction, and elimination of dead spaces should result in better process efficiency and effectiveness. The savings in chemical costs that can be achieved are apparent.

HYDRAULIC MODEL STUDIES

It was postulated that mild agitation of the contents of chlorine contact tanks with compressed air would eliminate or at least minimize most of the drawbacks in the operation and design of contact tanks. Air agitation also likely would enhance bacterial kill. The only contact tanks

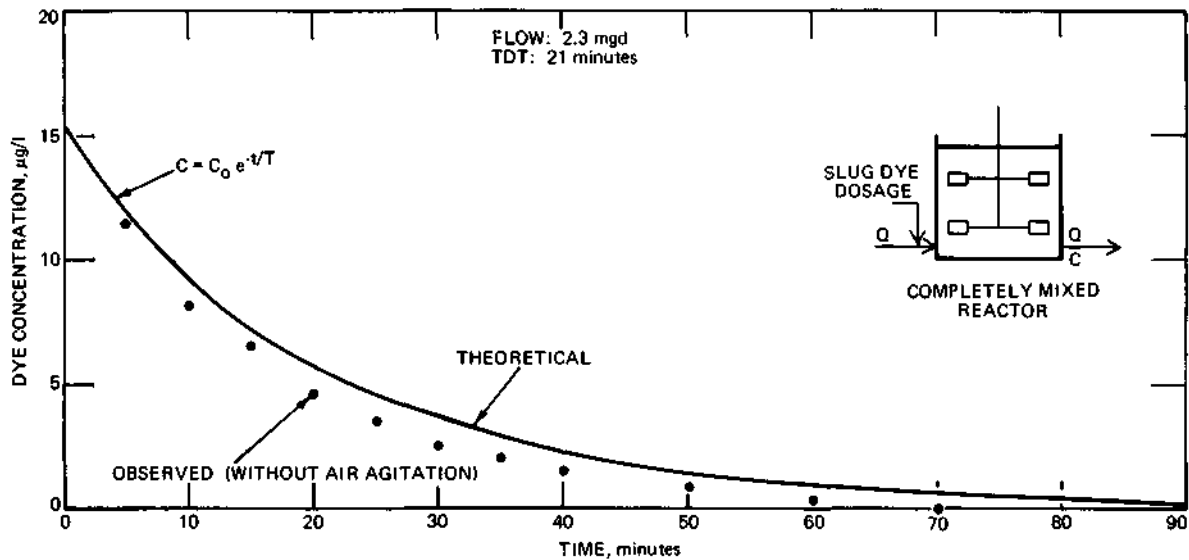

Figure 9. Flow-through curve of a theoretical completely mixed reactor and that for PWTP contact tank without air agitation

provided with diffusers for compressed air agitation, those at Pekin, did not prove to be adequate for verifying this hypothesis. The Pekin contact tank is a completely mixed type instead of the desirable plug flow type. It is very likely that appurtenances for providing air agitation of the chlorine contact tanks at Bloomington would vastly improve their overall performance characteristics.

The efficacy of air agitation in improving hydraulic flow-through characteristics and bacterial reduction by chlorination was investigated with hydraulic models of chlorine contact tanks and pilot laboratory-scale batch reactors.

Model Description

The hydraulic flow characteristics of the model contact tanks were observed by using rhodamine-B dye. The model was designed to represent a hypothetical prototype rectangular contact tank 120 feet long, 20 feet wide, and 15 feet water depth, with a linear scale ratio of 1:10.

The general scheme of the experimental setup is shown in figure 10a. Water was drawn from a constant-head tank through two flow meters into two perforated cylindrical baffles at the head end of the model tank. The cylindrical baffles were 5 inches in diameter and 20 inches high with 3/8-inch perforations. The cylindrical baffles destroyed most of the kinetic energy of the incoming jets. Two wire mesh screens placed 2 inches apart were interposed between the cylindrical baffles and the dye-dosing point. Household screen, 20 meshes per inch, mounted on a wooden frame was used. These screens served to suppress secondary eddy currents and to distribute the flow uniformly through the cross section of flow, as observed visually from the dye injection. The depth of flow in the model was maintained at 18 inches in all the experiments by manipulating the outflow control valve. Two wire mesh screens (the same as used at the inlet) were also placed at the outlet end to smooth out the flow in the exit end of the model.

The pump circulating water from the underground reservoir to the constant-head tank had a capacity greater than the flow through the model, so that it was possible to maintain a constant head in the model supply tank. Groundwater was used in this study, and the water temperature was brought by recirculation within the laboratory system to within ± 1 C of the room temperature to eliminate possible

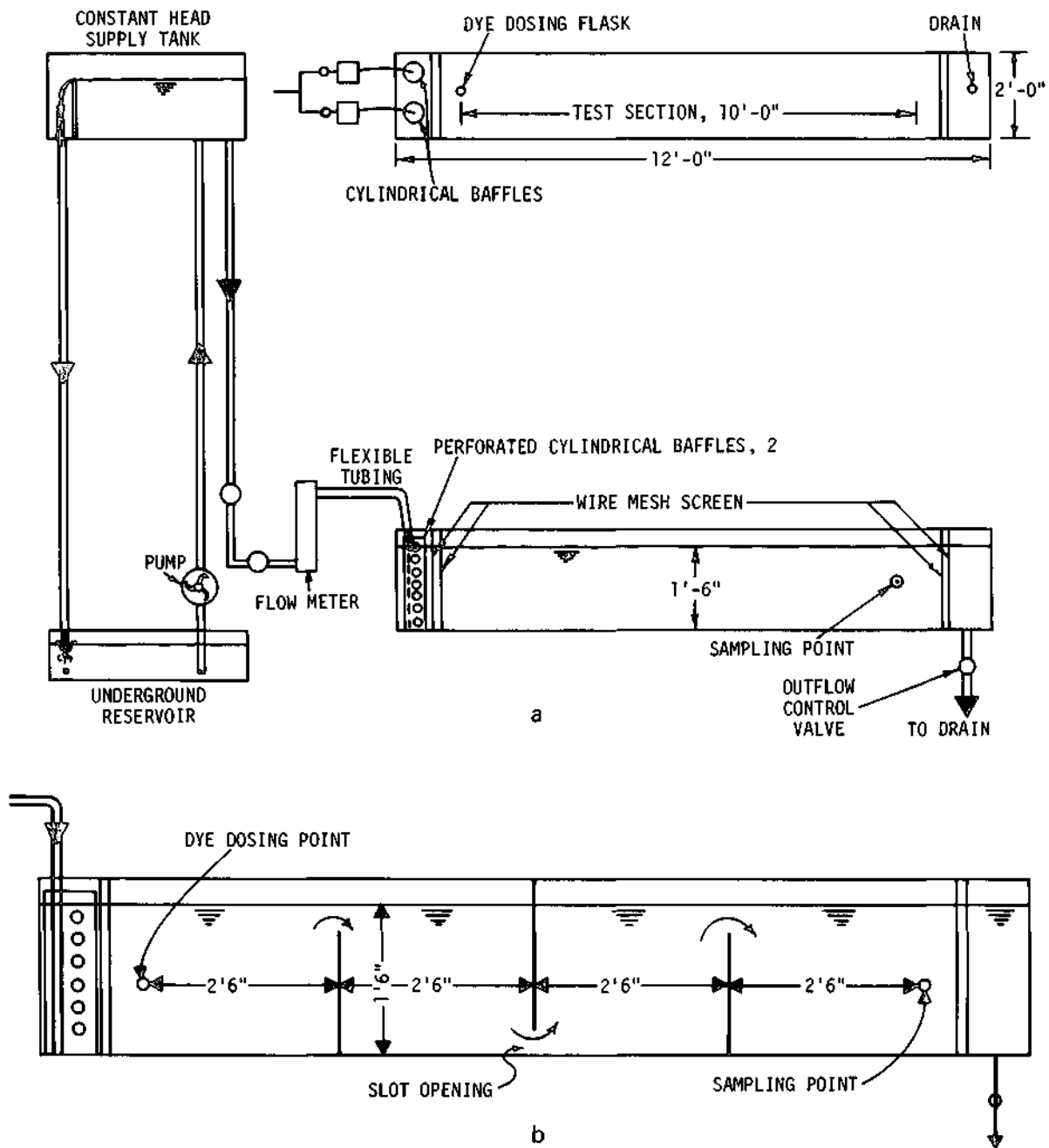

Figure 10. General scheme of experimental set-up for hydraulic model study (a) and baffle arrangement for the model tank (b)

density currents that might result from differences in air and water temperatures. TeKippe and Cleasby¹² have demonstrated the need for eliminating or at least minimizing this temperature differential in model studies.

Because the primary aim of this investigation was to devise means for improving the operating conditions of the contact chamber of the chlorine contact tank, no attempt was made to model the inlet and outlet structures of any existing facility. Instead, every effort was made to distribute the inflow into

the model tank as uniformly as possible and to observe the flow characteristics of the main body of the tank unaffected by the inflow and outflow structures under different operating conditions.

The flow characteristics were studied by dosing the tank with 75 ml of rhodamine-B dye at a concentration of 270 mg/l and observing the time-concentration relationship at a point near the exit end of the tank. The dosing and sampling points were located at the center of water flow sections 1 foot from either end of the model, leaving a test section of 10 feet. A separatory funnel with a long stem was fixed in position with respect to the model and used to dose the model. The dye was injected vertically downward by gravity flow, and it took less than 5 seconds to dose the tank. The tip of the dosing funnel terminated at the geometric center of the water flow section at 1 foot from the inlet end. Because the dosing arrangement was fixed in position and the dye injection was by gravity flow, uncertainties caused by variations in injection technique were minimized. Periodic grab samples at time intervals sufficient to define the time-concentration curve were taken at a distance of 10 feet from the dosing point with a 10-ml pipet and aspirator bulb combination. The tip of the pipet was at the geometric center of the flow section every time a sample was withdrawn. Disturbance from this withdrawal was insignificant.

The time-concentration relationship at the sampling point was observed under four different operating conditions:

- 1) Rectangular tank with only the inlet and outlet arrangement
- 2) Same as above but with the contents of the tank agitated by a controlled quantity of compressed air
- 3) Baffles added at suitable intervals in the contact chamber (without air agitation)
- 4) Same as 3 with the contents agitated by air

Air was supplied through a system of four copper tubes (3/4-inch diameter, 2.5 feet long, and separated to allow for later insertion of baffles) located along one side of the tank. The tubes were 2 inches from the bottom and 2 inches from the side of the tank. Holes 0.11 inch in diameter were spaced 1 inch apart along the length of the tubes. Air was supplied at a rate of 0.32 scfm/ft length of tubing (standard conditions, pressure 760 mm of mercury and temperature 0 C). The amount of air was enough to create a single roll in the tank without causing vigorous agitation. For the flow pattern with baffles, three baffles were installed and arranged so that water had an over and under flow pattern, as shown in figure 10b. The effects of 2-inch and 3-inch openings at the three baffles were studied. It should be emphasized here that the depth of flow in the model was kept at 1.5 feet in all the experiments.

Physical model studies provide useful results within practical limits. When the model and prototype are both principally influenced by the force of gravity, Froude's law of similarity is applicable, that is, $F_m = F_p$ where the characteristic parameter F represents the expression

$$F = V/(gL)^{0.5}$$

where

V = characteristic velocity of flow (mean velocity in this case)

g = acceleration caused by gravity

L = characteristic length (depth of flow in this case)

The subscripts m and p stand for model and prototype. Other forces such as viscosity and surface tension can be neglected.^{13,14} By using Froude's law, several scale ratios can be derived. Because

$$V_m/(L_m g)^{0.5} = V_p/(L_p g)^{0.5}$$

and L_p/L_m , has been taken as 10, the velocity ratio

$$V_p/V_m = (L_p/L_m)^{0.5} = 10^{0.5} = 3.162$$

and the time ratio

$$T_p/T_m = (L_p/L_m)(V_m/V_p) = 10^{0.5} = 3.162$$

In order to simulate the conditions of flow characteristics in the prototype, the detention time in the model should bear the relationship to the detention time of the prototype given by the time ratio. The model flow characteristics were observed under two different flow rates in order to cover the commonly used detention times of 20 to 30 minutes in the prototype. Table 13 shows the flow rates and detention times used in the model and the prototype. The flow characteristics for each of the flow rates were observed under all four different operating conditions indicated earlier.

Results of Model Studies

The time-tracer concentration relationships at the sampling point for a flow rate of 30.6 gpm are shown in figure 11. The curves for baffled flow are for a baffle opening of 2 inches in the model. It is seen from the figure that the baffled flow, without air agitation, has the widest spread in the flow-through curves and has the most severe short circuiting, as indicated by the initial appearance of the dye at the sampling point. The air agitated flow has flow characteristics only slightly better than that of the baffled flow. The baffled, air agitated flow has better flow characteristics than either the baffled flow or the air agitated flow alone. The flow characteristics of the model with only the inlet and outlet arrangements approach the ideal plug flow conditions. However, it becomes very difficult to distribute the flow uniformly across the cross section of the prototype tanks, and a certain degree of deviation from the ideal conditions is unavoidable. Moreover, because of the low velocity of flow through the chlorine contact tanks, solids accumulation and attendant problems cannot be minimized.

Similar flow-through characteristics were observed for the 3-inch baffle opening at the flow rate of 30.6 gpm and for all the operating conditions at the flow rate of 23.6 gpm.

The flow-through curves obtained in this study were evaluated by central tendency parameters and by the method using the $F(t)$ function.¹⁵ $F(t)$ stands for the fraction of total amount of tracer dosed, with a residence time less than or equal to the stipulated time, t .

Results of analysis of the flow-through curves for the flow rate of 30.6 gpm are shown in table 14, and those for the flow rate of 23.6 gpm are shown in table 15. It is seen from table 14 that agitating the contents of the model tank with air (without any baffling arrangements) results in poor hydraulic flow-through characteristics. The first appearance of the tracer at the sampling point is accelerated compared with the control (unobstructed flow), and the time for the passage of 90 percent of the tracer is delayed. The Morrill index seems to be relatively high in comparison with the control. The contact tank with baffles alone shows a similar tendency in flow characteristics and seems to be slightly inferior in flow characteristics to air agitated flow. The parameter t_g in the case of baffled flow is significantly higher than for any other operational condition. This is caused by the stagnation of the tracer in the dead spaces and subsequent release by diffusion to the main stream of flow, resulting in an elongated tail of the tracer curve. However, with air agitated baffled flow, the time for the first appearance of the tracer is retarded and t_{90} is closer to the theoretical detention time than with the nonagitated baffle flow. There seems to be considerable improvement in flow characteristics in the case of air agitated baffled flow.

Similar flow characteristics were observed at the flow rate of 23.6 gpm (table 15). Generally, it seems that the air agitated, baffled flow has superior flow characteristics when compared with either the air agitated flow or the baffled flow alone.

Only unobstructed flow (control) in the model tank approaches the plug-flow conditions, as measured by the Morrill index. However, such a flow condition will give rise to problems enumerated earlier. Because providing baffles in the chlorine contact tanks is commonly practiced in order to increase the flow path, it seems to be advantageous to mix the contents of the tanks with compressed air to create sufficient roll and prevent solids accumulation.

Table 13. Details of Flow Rates Used in the Model

Model		Prototype	
Flow rate (gpm)	Detention time (min)	Flow rate (mgd)	Detention time (min)
30.6	7.3	13.9	23.1
23.6	9.4	10.7	29.7

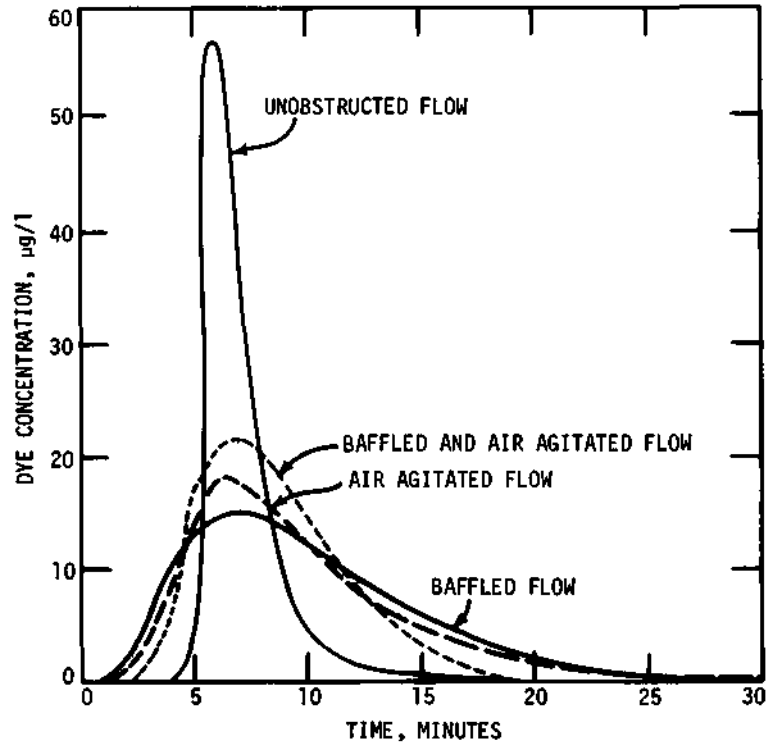

Figure 11. Flow-through curves at a flow rate of 30.6 gpm for the model

The results obtained by the method using the $F(t)$ function are also shown in tables 14 and 15. The parameter m stands for dead space or the stagnant volume of the reactor and $(1-m)$ represents the effective tank volume. The plug-flow fraction of the effective tank volume is designated by p . The term $(1-p)$ then represents the completely mixed fraction of the effective tank volume. It is seen from tables 14 and 15 that the plug-flow fraction is significantly increased in the case of baffled, air agitated flow. There seems to be a definite advantage in mixing the contents of the tank with air in addition to baffling the flow. The parameter signifying the dead space does not give a meaningful picture of the flow characteristics. This is probably caused by the slight degree of back-mixing of the tracer into the space of the tank upstream from the dosing point.

Table 14. Flow Characteristics of Hydraulic Model under Different Operating Conditions at a Flow Rate of 30.6 gpm

	Time (<i>minutes</i>) under given conditions					
	Control	Air only	2-inch baffle opening		3-inch baffle opening	
			Without air	With air	Without air	With air
t ₁₀	5.8	3.5	4.0	4.5	3.5	4.5
t ₉₀	10.5	13.5	15.5	13.5	16.8	13.0
t _p	6.5	6.0	7.0	7.0	7.0	7.0
t _g	7.8	8.8	10.0	8.7	10.1	8.9
t _m	7.0	7.5	8.8	7.5	8.5	7.5
Morril index*	1.8	3.8	3.9	3.0	4.8	2.9
p (%)	71.3	25.8	21.4	38.3	19.7	39.2
(1-p) (%)	18.7	74.2	78.6	61.7	81.3	60.8
m (%)	13.0	18.5	2.0	11.0	-8.0	14.0

*Morril index is dimensionless

Table 15. Flow Characteristics of Hydraulic Model under Different Operating Conditions at a Flow Rate of 23.6 gpm

	Time (<i>minutes</i>) under given conditions					
	Control	Air only	2-inch baffle opening		3-inch baffle opening	
			Without air	With air	Without air	With air
t ₁₀	6.8	5.0	5.0	5.5	4.5	5.5
t ₉₀	12.3	18.5	21.5	15.0	20.5	17.0
t _p	7.5	8.3	8.8	9.0	8.5	9.0
t _g	9.0	11.8	12.6	11.9	12.4	11.5
t _m	8.0	10.0	11.0	9.3	10.5	9.5
Morril index*	1.8	3.7	4.3	2.7	4.6	3.1
p (%)	67.8	30.1	26.8	35.0	25.9	32.0
(1-p) (%)	32.2	69.9	73.2	65.0	74.1	68.0
m (%)	23.0	14.0	-2.0	23.0	-4.5	16.0

*Morril index is dimensionless

AIR AGITATION OF TREATMENT PLANT EFFLUENTS

The effects of air agitation on total residual chlorine concentration and on bacterial reduction in chlorinated waste treatment plant effluents were investigated with the use of secondary settling tank effluents from waste water treatment plants serving the cities of Morton, Peoria, and Washington, Illinois. As a minimum, three effluent samples from each waste water treatment plant, obtained on different days of the week, were examined.

The Peoria plant employs a high rate activated sludge process treating a combination of domestic and industrial wastes. Contact stabilization comparable to the standard rate activated sludge process is used at Morton. This plant treats principally domestic waste. Washington is served by a standard rate trickling filter plant, treating domestic wastes also.

A grab sample of about 50 liters of secondary effluent was obtained on each day of the experimental runs. Ten liters of the collected sample was vigorously agitated for 5 minutes prior to chlorination. Samples for bacteriological analyses were obtained before and after vigorous agitation for determining bacterial counts prior to any chlorination. This agitation before chlorination was done with the expectation of reducing the size of suspended solids in the samples and thereby exposing the organisms harboring within them. There was no significant difference in the bacterial counts obtained before and after agitation. However, all the experimental runs except for two samples from the Peoria plant were initially agitated vigorously.

The 10-liter portion of a day's grab sample was dosed with calcium hypochlorite solution (70 percent available chlorine) at the desired rates, was well mixed, and then immediately divided into two portions. One portion was allowed to stand quiescently and the other was agitated with compressed air at the rate of 170 cc/min/liter (170 cfm/1000 cubic feet). This rate of aeration is considerably in excess of the maximum rate of 12 cfm/1000 cubic feet recommended for aerated grit chambers.¹⁶ Aliquots were withdrawn at frequent intervals from these two portions, and the total residual chlorine concentrations were determined. Aliquots were also withdrawn at 15-minute contact time from the agitated and quiescent samples for bacteriological examinations. The quiescent sample was gently mixed with a magnetic stirrer for about 15 seconds immediately before withdrawal of the bacteriological sample. Four separate tests runs with different chlorine dosage rates were carried out on each of the secondary effluent samples.

Effects on Total Chlorine Residual

Comparison of total residual chlorine concentrations under conditions of quiescence and air agitation for the secondary effluents of Morton, Peoria, and Washington are shown in table 16. The experimental observations show that the total residual chlorine concentrations were the same in the quiescent and air agitated systems at the corresponding time periods under all chlorine dosage rates tested, for all the three treatment plant effluents. Similar results were obtained for all the other experimental runs.

Peoria treatment plant effluent samples were also subjected to a very vigorous rate of air agitation, at a rate of 5600 cc/min/liter (5600 cfm/1000 cubic feet). The effects of this intense air agitation at four different chlorine dosages are shown in figure 12. Again, no significant difference in total residual chlorine concentrations could be detected between the quiescent and air agitated systems.

From these tests, it can be reasonably concluded that there is no loss of total chlorine residuals due to air agitation of chlorinated secondary waste effluents in a period of 30 minutes.

Effects on Bacterial Reduction

Typical results of survival rates of total coliform and fecal coliform under conditions of quiescence and air agitation are shown in figure 13. Except for the results shown in figure 13a, the bacterial survival rates in the air agitated system were found to be less than in the quiescent system.

Figure 13a typifies the results of experiments performed on three samples collected on three different days at Peoria when there was an extended period of heavy rainfall. Samples collected on these days had unusually high suspended solids concentrations. Experiments carried out on samples collected on two days from the Peoria treatment plant when the flow through the plant was typical (figure 13b) produced results conforming to the general trend of better bacteriological reduction in chlorinated samples of an air agitated system.

With a very few exceptions, percent survival of all the test bacteria in the air agitated system for Morton samples was found to be less than that in the quiescent system (figure 13c). Slightly higher survival rates under agitated conditions were observed only at chlorine dosage rates of less than 2 mg/l. In the Washington samples (figure 13d), except for one observation of fecal coliform, survival rates were all lower under agitated conditions.

Table 16. Residual Chlorine Concentrations in Air Agitated and Quiescent Samples

(Concentrations in milligrams per liter)

Time (min)	Air Agitated		Time (min)	Quiescent		Time (min)	Air Agitated		Time (min)	Quiescent	
	Morton	Washington		Morton	Washington		Peoria	Peoria			
<i>Run 1</i>											
0	1.4	1.2	0	1.4	1.2	0	1.4	0	0	1.4	1.4
4	0.6	0.7	1	0.6	0.8	6	0.3	1	1	0.3	0.3
12	0.55	0.65	8	0.6	0.7	12	0.3	9	9	0.3	0.3
20	0.55	0.65	16	0.55	0.65	20	0.25	17	17	0.25	0.25
28	0.5	0.65	25	0.55	0.65	28	0.2	25	25	0.25	0.25
<i>Run 2</i>											
0	1.9	2.1	0	1.9	2.1	0	2.4	0	0	2.4	2.4
4	1.0	1.35	1	1.05	1.35	4	1.05	1	1	1.0	1.0
12	0.95	1.3	8	1.0	1.25	12	1.05	9	9	1.05	1.05
20	0.95	1.25	16	0.95	1.3	21	1.0	17	17	1.0	1.0
28	0.9	1.25	25	0.95	1.25	27	0.95	25	25	1.0	1.0
<i>Run 3</i>											
0	2.9	3.2	0	2.9	3.2	0	3.8	0	0	3.8	3.8
4	1.55	2.25	1	1.6	2.3	5	2.5	8	8	2.5	2.5
12	1.5	2.15	8	1.5	2.2	11	2.5	14	14	2.4	2.4
20	1.45	2.1	16	1.45	2.15	17	2.2	20	20	2.2	2.2
28	1.45	2.05	25	1.45	2.1	25	2.2	32	32	2.1	2.1
<i>Run 4</i>											
0	4.0	4.1	0	4.0	4.1	0	6.7	0	0	6.7	6.7
4	1.45	2.3	1	1.6	2.5	5	3.5	1	1	3.7	3.7
12	1.4	2.2	8	1.4	2.3	12	3.7	8	8	3.7	3.7
20	1.35	2.2	16	1.35	2.1	22	3.4	18	18	3.6	3.6
28	1.35	2.05	25	1.35	2.1	26	3.5	30	30	3.6	3.6

A statistical test of the observed data was made with the t-test of pairing observations to determine whether there is a significant difference in the survival rates under the two different systems. The results indicated that there was no statistical difference in the mean values of the bacterial counts for all three test organisms in the two systems for the Morton and Peoria samples. However, with the Washington samples, the better bacterial removal with air agitation was found to be statistically significant.

Though there is no statistical difference in the survival rates of total coliform and fecal coliform in most of the chlorinated effluent samples treated under two different conditions, there is a consistent trend suggesting that bacterial counts are numerically less in the air agitated system. Glover¹⁷ has presented data to indicate that the coliform survival rates decrease with increasing values of the product of velocity gradient and contact time. He is of the opinion that mixing intensity is as important as contact time in disinfection.

SPLIT CHLORINATION OF SECONDARY WASTE EFFLUENTS

Split chlorination as a method of disinfection was advocated as early as 1956.⁸ However, the method has not been adopted in waste treatment plants nor researched. Split chlorination, as used here, refers to the concept whereby a portion of the total applicable chlorine dosage is admin-

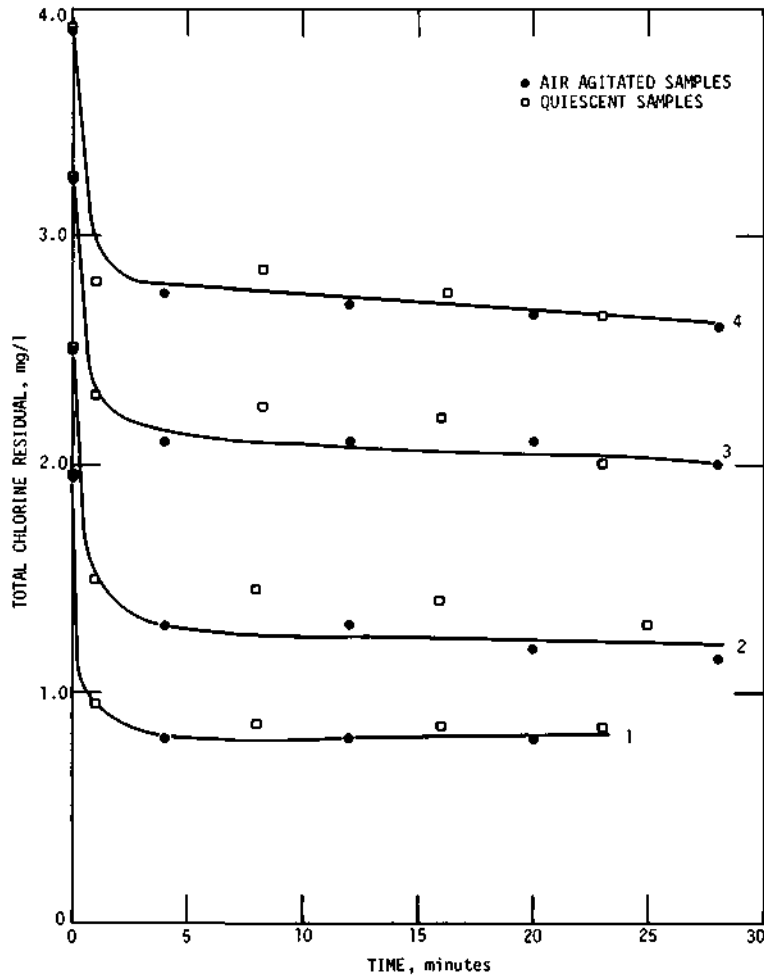

Figure 12. Comparison of total residual chlorine concentrations in quiescent and vigorously air agitated samples, Peoria plant effluent

istered at the head end of the contact chamber and the remainder is added at some other location along the contact basin. Imhoff and Fair⁸ define the term split chlorination as ". . . the addition of half the chlorine at the entrance to the reaction, or contact, chamber and the other half at the midpoint of the chamber." They have opined that split chlorination improves the bacterial kill when it reduces the chlorine demand that is exerted. They strongly urge that split chlorination be considered (Imhoff and Fair,⁸ pp. 166 and 171).

Collins and Selleck⁶ experimenting with settled sewage came to the conclusion that the germicidal activity of chlorine residual decreases measurably with time. Consequently, it is probable that chlorination of waste water effluents at two different points in the contact basin could enhance the process efficiency.

Experiments

The bacterial kills with split chlorination in secondary waste effluents under both quiescent and air agitated conditions were evaluated separately and compared with the bacterial kill obtained from single point chlorination under quiescent conditions, all in batch reactors.

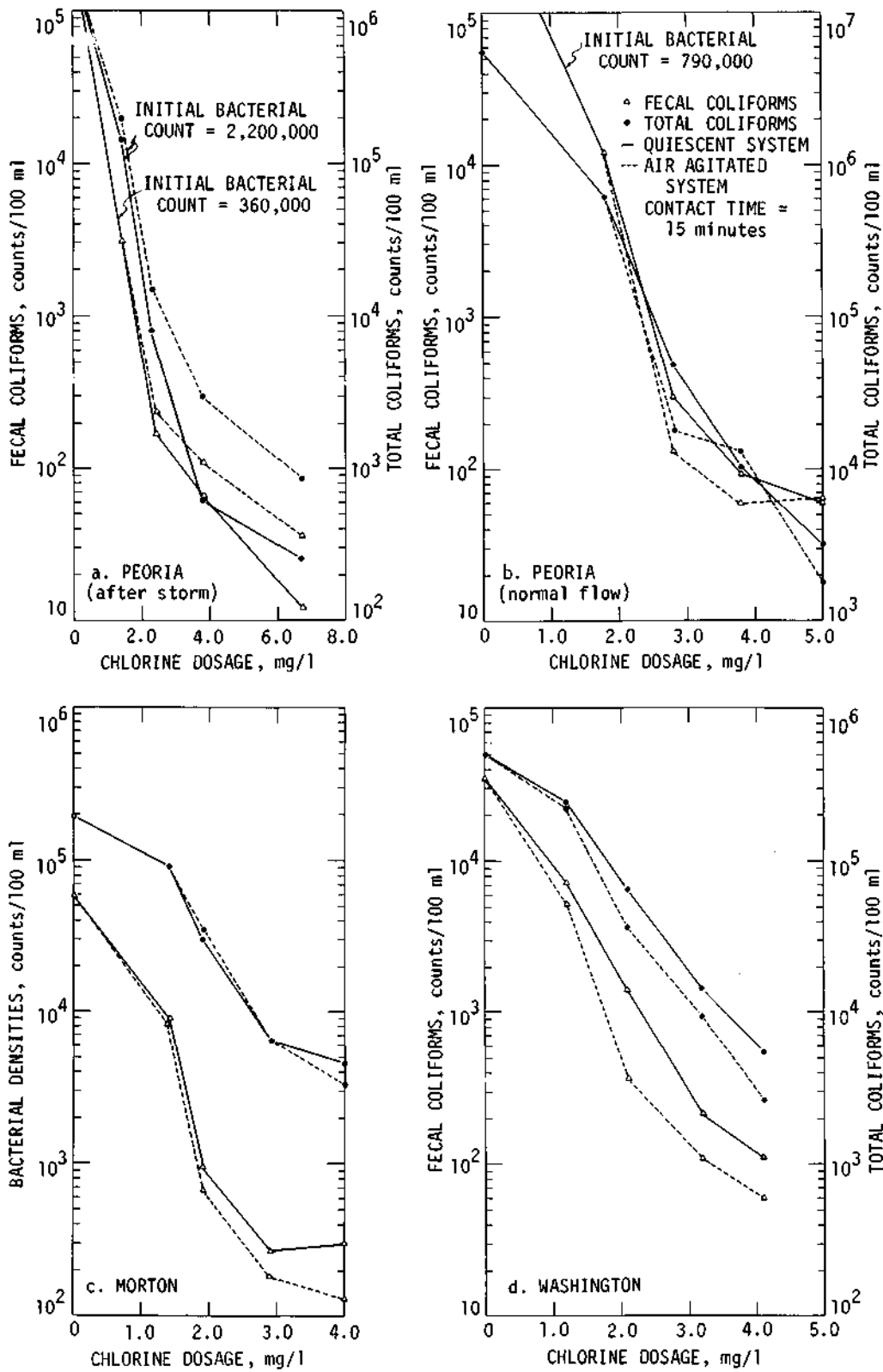

Figure 13. Comparison of bacterial survival in quiescent and air agitated systems for Peoria plant effluent during heavy rainfall period (a); for Peoria plant effluent during normal conditions (b); for Morton plant effluent (c); and for Washington plant effluent (d)

Secondary settling tank effluents from the Pekin and Peoria waste treatment plants were used in this study. A grab sample of about 20 liters of secondary effluent was obtained on each day of the experimental runs from one of the treatment plants. An enumeration of the initial bacterial densities was performed on each sample prior to any chlorination. Two batch reactors were set up in which 2 liters of effluent samples were placed in each. One of the reactors was dosed in a single installment with calcium hypochlorite solution (70 percent available chlorine) at the desired dosage rate and allowed to stand quiescently as a control for the chlorination process.

Initially, the sample in the second reactor was dosed (from the same stock hypochlorite solution) at a fraction of the dosage rate for the control reactor. The remainder of the chlorine dosage was administered at one-third of the total contact time (which corresponds to the one-third point in space in an actual contact basin). Samples were withdrawn for bacterial analysis at the end of 15 minutes contact time for the control and at the end of 15 minutes from the *initial* chlorine dosage for the split chlorination reactor. Total residual chlorine concentrations were determined immediately. The experiments were repeated with two other total dosage rates but with the same secondary point of chlorine application for the split chlorination. For every change in test condition for split chlorination, a control chlorination reactor was set up.

Three test runs at three different total chlorine dosage rates constituted a series of tests. These series of experiments were repeated at the same total dosage rates but with the secondary points of chlorine application shifted from the first third point to midpoint and then to the last third point in time. All experimental runs for split chlorination were carried out under quiescent and air agitated conditions, separately.

Total chlorine dosage rates and the contact time of 15 minutes were chosen in order that the results of bacterial analyses of the chlorinated samples would be meaningful for comparative purposes. A too high dose or a too long period of contact may result in very low bacterial counts, rendering the comparison between controls and the test samples impossible.

Results

The results of split chlorination under quiescent conditions with the use of Greater Peoria Sanitary District secondary effluents are shown in table 17. The first row for each series shows the initial bacterial densities in the effluent sample prior to chlorination. The contact times for each dosage, both single and split, are shown in parentheses. The sum of the split dosages, in each case, is equivalent to the control dosage above it.

Table 17 shows that for any given total dosage rate the residual chlorine concentrations are nearly the same for both the split and single point chlorination. The relative fractions of the initial to the subsequent dosage rates apparently do not have any bearing on the final total residual concentrations.

The pairs of experimental results favorable to the split chlorination practice are marked by an asterisk. Those pairs for which single point chlorination results are better are marked by a dagger. There was no discernable trend to establish whether the split chlorination is advantageous or not. It should be noted that in certain cases, for example fecal coliform counts at the 2.8 mg/l dosage rates in the first and third series on table 17, the decision shown is tenuous. Considering the degree of dilution needed and the problems inherent in the bacterial enumeration procedure, differences in the bacterial densities are not significant.

The results of split chlorination under air agitated conditions with Peoria plant secondary effluents are shown in table 18. On the basis of the total coliform counts, the results of split chlorination under air agitated conditions are inferior. However, on the basis of the fecal coliform determinations, the results appear to be inconclusive.

Table 17. Split Chlorination under Quiescent Conditions, Peoria

Chlorine dosage [☆] (mg/l)	Residual chlorine (mg/l)	Total coliform (counts/ 100 ml)	Fecal coliform (counts/ 100 ml)
<i>First series</i>			
0		1,700,000	80,000
2.0(15)	1.35	10,500	160
1.5(15) + 0.5(10)	1.40	13,000)†	210)†
2.8(15)	2.15	14,500)*	98)*
1.5(15) + 1.3(10)	2.00	1,900)*	80)*
3.5(15)	2.75	13,000)*	120)*
1.5(15) + 2.0(10)	2.45	500)*	105)*
<i>Second series</i>			
0		2,200,000	
2.0(15)	1.20	17,000)†	70)†
1.5(15) + 0.5(7.5)	1.30	45,000)†	200)†
2.8(15)	1.85	3,000	32)†
1.5(15) + 1.3(7.5)	1.80		148)†
3.5(15)	2.45		34
1.5(15) + 2.0(7.5)	2.30	6,000	35
<i>Third series</i>			
0		4,700,000	180,000
2.0(15)	1.10	35,000	200)*
1.5(15) + 0.5(5)	1.90	35,000	35)*
2.8(15)	1.85	1,300)†	20)†
1.5(15) + 1.3(5)	2.70	2,400)†	90)†
3.5(15)	2.45	17,000)*	225)*
1.5(15) + 2.0(5)	2.60	9,100)*	40)*

☆ *Italic numbers in parentheses show contact time in minutes*

* Results favorable to split chlorination practice

† Results favorable to single point chlorination

Table 18. Split Chlorination under Air Agitated Conditions, Peoria

Chlorine dosage [☆] (mg/l)	Residual chlorine (mg/l)	Total coliform (counts/ 100 ml)	Fecal coliform (counts/ 100 ml)
<i>First series</i>			
0		650,000	35,000
2.0(15)	1.30	39,000	1,100)*
1.5(15) + 0.5(10)	1.35	44,000)†	90)*
2.8(15)	0.80	1,700)†	14)†
1.5(15) + 1.3(10)	2.30	16,000)†	80)†
3.5(15)	2.50	1,900)†	32)†
1.5(15) + 2.0(10)	2.80	12,000)†	45)†
<i>Second series</i>			
0		2,400,000	360,000
2.0(15)	0.20		
1.5(15) + 0.5(7.5)	0.40		
2.8(15)	0.80		
1.5(15) + 1.3(7.5)	0.80	33,000	350
3.5(15)	1.00	4,900)†	320)*
1.5(15) + 2.0(7.5)	1.05	26,000)†	230)*
<i>Third series</i>			
0			21,000
2.0(15)	1.00	16,000)†	430)*
1.5(15) + 0.5(5)	1.20	130,000)†	160)*
2.8(15)	1.65	21,000)†	400)*
1.5(15) + 1.3(5)	1.90	78,000)†	40)*
3.5(15)	2.30	1,300)†	40)†
1.5(15) + 2.0(5)	2.50	15,000)†	300)†

☆ *Italic numbers in parentheses show contact time in minutes*

* Results favorable to split chlorination practice

† Results favorable to single point chlorination

Tables 19 and 20 show the results of split chlorination under quiescent and air agitated conditions, respectively, with the Pekin plant secondary effluent. Under quiescent conditions, from both total coliform and fecal coliform results, bactericidal effects of split chlorination appear to be far inferior to single point chlorination. However under air agitated conditions, for the fecal coliform counts, which are increasingly being recognized as a process control parameter, split chlorination appears to be superior. The results based on total coliforms are inconclusive.

The results of air agitation on split chlorination also seem to be mixed. The combination of air agitation and split chlorination appears to be preferable on the basis of results for Pekin plant effluent samples, while the contrary holds for Peoria plant samples.

In general, from the results obtained in this study, split chlorination does not appear to be an advantageous procedure in waste water chlorination practice.

SUMMARY

A survey of the operating and performance characteristics of existing chlorine contact tanks at three locations in Illinois indicates that invariably all of the contact chambers are beset with serious drawbacks of dead space and short circuiting.

The rectangular cross-baffled contact unit for the trickling filter plant at the Bloomington-Normal Sanitary District (BNSD) was found to suffer from large amounts of solids accumulation which subsequently putrefied exerting undue chlorine demand. Rising gas bubbles, indicative of putrefaction, were visible all the time. The invert level of the outlet pipes of this contact unit is about 8 feet from the bottom and there are no facilities for removing the settled solids except by taking the unit off of the main stream of treatment and pumping the sludge with a portable pump. The longitudinally baffled contact unit for the activated sludge plant at the same location performed better than the unit for the trickling filter; this activated sludge unit had slightly better hydraulic flow characteristics and more importantly, the accumulated solids could be flushed out easily, this being done at least once in 2 to 4 weeks.

The unbaffled rectangular contact unit of the Aurora Sanitary District (ASD) was found to provide excellent bacterial reduction. The contact units in ASD are equipped with mechanical sludge collecting devices that are also preceded by a mechanical flash mixing chamber where the chlorine solution and the waste stream are mixed. The contact unit investigated, even though suffering from a serious short circuiting problem, provided a minimum contact time of 15 minutes. As a result, the bacterial quality of the effluent from this contact unit met the Illinois Pollution Control Board bacterial standard for waste effluents, at all five times examined.

At the Pekin waste treatment plant (PWTP), the chlorine contact unit, which is in the form of a truncated segment of the sector of a circle, was found to have flow characteristics similar to a completely mixed tank instead of the plug-flow type. The dye tracer arrived at the outlet end within a minute after introduction to the inlet, even though the theoretical contact time was not less than 21 minutes. A chlorine dosage rate of not less than 5.5 mg/l was required to ensure compliance with bacterial quality standards. In contrast, a chlorine dosage rate of 2.8 mg/l with a contact time of 15 minutes in a batch reactor using PWTP secondary settling tank effluent was found to be more than adequate to meet the effluent quality standards.

Hydraulic model studies of chlorine contact tanks indicate that air agitated baffled units will provide the best hydraulic flow-through characteristics consistent with the objective of preventing solids accumulation in the tank. The argument that chlorine contact units provide the last chance to trap the solids that would otherwise escape to the receiving waters is not tenable. Such a condition would defeat the primary purpose of the unit process since putrefying solids reduce the efficiency and effectiveness of disinfection by chlorination.

Table 19. Split Chlorination under Quiescent Conditions, Pekin

Chlorine dosage [☆] (mg/l)	Residual chlorine (mg/l)	Total coliform (counts/ 100 ml)	Fecal coliform (counts/ 100 ml)
<i>First series</i>			
0			70,000
1.5(15)	0.55		1,000
0.8(15) + 0.7(10)	0.55		1,000
2.3(15)	1.60		140)†
0.8(15) + 1.5(10)	1.95		220)
2.8(15)	1.80		30)†
0.8(15) + 2.0(10)	2.05		140)†
<i>Second series</i>			
0		7,360,000	130,000
1.2(15)	0.65	180,000	4,000)†
0.8(15) + 0.4(7.5)	0.75	670,000)†	12,000)†
2.0(15)	1.45	41,000	220)†
0.8(15) + 1.2(7.5)	1.45	137,000)†	1,900)†
2.8(15)	1.95	9,000	600)*
0.8(15) + 2.0(7.5)	2.15	80,000)†	450)*
<i>Third series</i>			
0		500,000	9,000
1.2(15)	0.35	49,000	900)†
0.8(15) + 0.4(5)	0.35	80,000)†	1,900)†
2.0(15)	0.85	13,000	150)†
0.8(15) + 1.2(5)	0.85	32,000)†	500)†
2.8(15)	1.30	8,000	45)†
0.8(15) + 2.0(5)	1.20	29,000)†	1,500)†

☆ *Italic numbers in parentheses show contact time in minutes*

* Results favorable to split chlorination practice

† Results favorable to single point chlorination

Table 20. Split Chlorination under Air Agitated Conditions, Pekin

Chlorine dosage [☆] (mg/l)	Residual chlorine (mg/l)	Total coliform (counts/ 100 ml)	Fecal coliform (counts/ 100 ml)
<i>First series</i>			
0		620,000	66,000
1.2(15)	0.35	87,000)†	790)†
0.8(15) + 0.4(10)	0.50	220,000)†	2,000)†
2.0(15)	0.75	17,000)*	100)*
0.8(15) + 1.2(10)	1.25	3,700	45)*
2.8(15)	1.40	1,340	280)*
0.8(15) + 2.0(10)	1.75	2,000)†	32)*
<i>Second series</i>			
0		800,000	69,000
1.2(15)	0.30	130,000)*	7,800)*
0.8(15) + 0.4(7.5)	0.30	17,000)*	300)*
2.0(15)	0.50	7,400)†	600)*
0.8(15) + 1.2(7.5)	0.70	9,000)†	550)*
2.8(15)	0.75	2,100)†	170)†
0.8(15) + 2.0(7.5)	0.90	2,900)†	260)†
<i>Third series</i>			
0		2,700,000	180,000
1.2(15)	0.20	48,000)*	2,400)*
0.8(15) + 0.4(5)	0.35	15,000)*	1,000)*
2.0(15)	0.40	8,000)†	950)*
0.8(15) + 1.2(5)	0.50	10,000)†	430)*
2.8(15)	0.50	3,500)*	330)*
0.8(15) + 2.0(5)	0.65	2,400)*	180)*

☆ *Italic numbers in parentheses show contact time in minutes*

* Results favorable to split chlorination practice

† Results favorable to single point chlorination

Air agitation of chlorinated secondary effluents did not result in a loss of total chlorine residual. Efficiency of bacterial reduction was enhanced, though slightly, by air agitation. Split chlorination of waste effluents does not appear to be an advantageous modification in chlorination practice.

Air agitation of the contents of chlorine contact tanks should improve hydraulic flow-through characteristics of the units by minimizing dead spaces and short circuiting problems. Solids accumulation and their subsequent decay in the contact units could be eliminated. Increased dissolved oxygen concentration of the effluents will be an added benefit. Such a scheme could be implemented, fairly easily, in existing plants and could be incorporated in the design of new units.

RECOMMENDATIONS

The fact that the design of chlorine contact units based on volume displacement criteria alone is grossly inadequate has been amply demonstrated in this study and by others.¹⁻⁶ Careful considerations to inlet and outlet structures of the tank, initial rapid and complete mixing of chlorine solution into the waste flow, and minimum desired residence time for bacterial reduction should receive careful consideration in the design of these units.

On the basis of experience gained from this study, the following recommendations are offered:

- 1) All chlorine contact units should be designed on the basis of providing a minimum residence time of 15 minutes. [Minimum residence time should not be confused with theoretical detention time.] Any design permitting the arrival of a tracer at the outlet before 15 minutes have elapsed should be rejected; and any existing operating units not in conformity with this criterion should be modified accordingly.
- 2) The application of a disinfectant should be limited to inflow pressure conduits or flash mixing chambers (mechanical or air agitated) at a point preceding the contact zone of the contact unit.
- 3) The inlet and outlet structures should be designed to distribute the waste flow uniformly within the cross section of the contact chamber.
- 4) In the absence of air agitation, adequate provisions should be made for the efficient removal of accumulated solids in the contact unit on at least a once-a-day basis.
- 5) Air for 'air agitation' should be supplied at the rate of 4 cubic feet per minute per foot of header length or 6 to 8 cubic feet per minute per 1000 cubic feet of tank volume.
- 6) Curtain walls, baffles, and directional vanes, strategically positioned, are considered acceptable means for achieving minimum residence time requirements.

REFERENCES

- 1 Louie, D. S., and M. S. Fohrman. 1968. *Hydraulic model studies of chlorine mixing and contact chambers*. Journal Water Pollution Control Federation, v. 40(2): 174-184.
- 2 Marske, D. M., and J. D. Boyle. 1973. *Chlorine contact chamber design — A field evaluation*. Water and Sewage Works, v. 120(1): 70-77.
- 3 Sawyer, C. M. 1967. *Tracer studies on a model chlorine contact tank*. M.S. thesis, Virginia Polytechnic Institute, Blacksburg, Virginia. 163 p.
- 4 Stephenson, R. L., and J. R. Lauderbaugh. 1971. *Baffling chlorine contact tanks*. Water and Sewage Works, v. 118(R.N.):R100-R103.
- 5 Warick, J. W. 1968. *Tracer studies on a circular chlorine contact tank*. B.S. thesis, Virginia Military Institute, Lexington, Virginia. 40 p.
- 6 Collins, H. F., and R. E. Selleck. 1972. *Process kinetics of wastewater chlorination*. University of California, Berkley, California, Sanitary Engineering Research Laboratory, Report No. 72-5. 91 p.
- 7 Lin, S. D. 1973. *Evaluation of coliform tests for chlorinated secondary effluents*. Journal Water Pollution Control Federation, v. 45(3):498-506.
- 8 Imhoff, K., and G. M. Fair. 1956. *Sewage treatment*. Second Edition, John Wiley & Sons, Inc., New York. 338 p.
- 9 Wallace and Tiernan. *Instruction Book No. WAA 50261*. 25 Main Street, Bellville, New Jersey (not dated).
- 10 American Public Health Association. 1971. *Standard methods for the examination of water and wastewater*. 13th Edition, New York. 874 p.
- 11 Sullivan, W. T. 1967. *Chemical composition of mud-water interface zone with the description of an interface sampling device*. Proceedings, Tenth Conference on Great Lakes Research, pp. 390-403.
- 12 TeKippe, R. J., and J. L. Cleasby. 1968. *Model studies of a peripheral feed settling tank*. Journal Sanitary Engineering Division, Proceedings of the American Society of Civil Engineers, v. 94(SA1):85-102.
- 13 Langhaar, H. L. 1951. *Dimensional analysis and theory of models*. John Wiley & Sons, Inc., London, England. 166 p.
- 14 Committee of the Hydraulic Division on Hydraulic Research. 1942. *Hydraulic models*. American Society of Civil Engineers, New York, New York. 110 p.
- 15 Wolf, D., and W. Resnick. 1963. *Residence time distribution in real systems*. Industrial and Engineering Chemistry Fundamentals, v. 2(4):287-293.
- 16 Sperry, J. R. *Aerated grit chambers*. Walker Process Division, Chicago Bridge and Iron Co., Aurora, Illinois. Mimeographed document, 4 p. (not dated).
- 17 Glover, G. E. 1972. Discussion of the paper *Problems in Obtaining Adequate Sewage Disinfection* by F. H. Collins *et al.* Journal of the Sanitary Engineering Division, Proceedings of the American Society of Civil Engineers, v. 98(SA4):671-673.