

BASCOME

A Study of Concrete Mixers

Civil Engineering

B. S.

1912

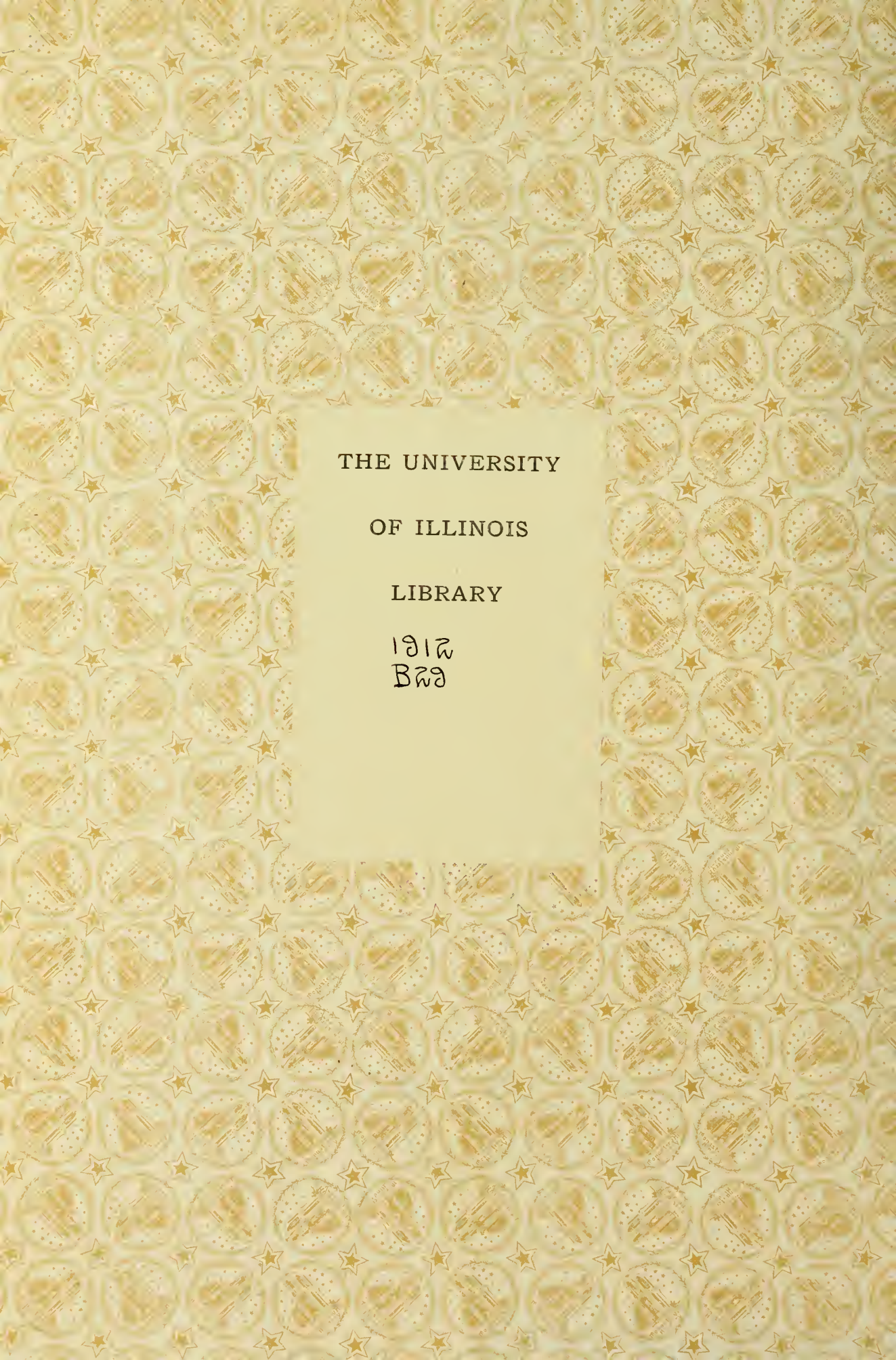

THE UNIVERSITY
OF ILLINOIS
LIBRARY

၂၅၂၃
B၃၅



A STUDY OF CONCRETE MIXERS

BY

BARTOW STRANG BASCOME

THESIS

FOR THE

DEGREE OF BACHELOR OF SCIENCE

IN

CIVIL ENGINEERING

COLLEGE OF ENGINEERING

UNIVERSITY OF ILLINOIS

1912

1912
B29

UNIVERSITY OF ILLINOIS
COLLEGE OF ENGINEERING.

May 24, 1912

This is to certify that the thesis of BARTOW STRANG BAS-
COME entitled A STUDY OF CONCRETE MIXERS was prepared under my
personal supervision; and I recommend that it be approved as meet-
ing this part of the requirements for the degree of Bachelor of
Science in Civil Engineering.

R. C. Davis.

Instructor in Civil Engineering.

Recommendation approved:

Ira O. Baker.

Professor of Civil Engineering.



TABLE OF CONTENTS

	Page
Introduction	1- 3
Description with illustrations of Early Types of Concrete Mixers	3- 6
Classification of Mixers in General Use at the Present Time	6- 8
List of Mixers	9
Description and Illustrations of Individual Continuous Mixers:-	
The Kent Precision	10-13
The Besser Simplex	13-15
The S & S Elevating	15-18
The Hartwick	18-24
The Grand	24-25
The Coltrin	25-28
The Simplex	28-32
The Bolte	32-33
The Low Down Forced Feed	33-36
The Eureka	36-40
The Cockburn	40-41
Description and Illustrations of Individual Batch Mixers:-	
The Eclipse	41-44
The Koehring	44-48



Digitized by the Internet Archive
in 2013

<http://archive.org/details/studyofconcretem00basc>



	Page
The Cream City	48-51
The Polygon	51-55
The Clover Leaf	55-56
The Ransome	56-59
The Marsh-Capron	59-66
The Foote	66-70
The Chicago	70-73
The Chain Belt	74-78
The Chicago Cube	78-81
The Cockburn	81-83
The North Western	83-86
The Milwaukee	87-89
The Smith	89-94
The Hains	94-98
Loading Attachments	95,99,100
Discharging Attachments	100
Table of Cost Data	101-102
Conclusion	103-107

A STUDY OF CONCRETE MIXERS

Introduction.

Concrete consists of mortar in which are embedded pebbles or broken stone or pieces of stone. At present the mortar used in making concrete is invariably cement, although in ancient times lime was used. Concrete has been in use from remote antiquity, but it is only during the last twenty years that it has been used to any extent. The rapid rise of its use has been influenced by the development of the American Portland Cement industry. It is admirably adapted to a variety of most important uses. For foundations in damp and yielding soils, for subterranean and submarine masonry, it is superior to brick in strength, hardness, and durability. Besides being more economical, concrete is, in most cases, a safer substitute for the best stone. For submarine masonry, it possesses the advantage that it can be laid, under certain precautions, without exhausting the water and without the use of a diving bell or submarine armor. On account of its continuity and its impermeability to water, it is an excellent material to form a substratum in soils infested with springs. It is almost in universal use for basements and retaining walls, for piers and abutments, and for pavements, sidewalks, cisterns, etc. Again, concrete gains a great deal of importance for the use to which it has been put in a marked degree during the last ten years, namely reinforced concrete. This combination is defined as concrete having metal embedded in it so that the two materials assist each other in supporting the stresses imposed upon the structure. Reinforced

concrete is valuable as a building material not only from the fact that it possesses great strength but also from the fact that it protects the steel from corrosion and fire. The statement can be made unhesitatingly that at the present time no structure of any importance is made without containing some form of concrete.

The earlier method of mixing concrete was by hand, but this process, though suitable for small quantities, is unsuitable when volumes of a hundred cubic yards are in question. The method of hand mixing consists of placing the sand evenly upon a mixing board, and the requisite amount of cement uniformly over the sand. These are turned with a shovel until thoroughly mixed. Usually two turnings give a uniform mixture. The proper amount of stone and water is then added, and the ingredients are turned over and over with shovels, usually six times, until they are thoroughly mixed.

It has been claimed that hand mixing is more efficient than machine mixing; but this claim is not sustained at the present day, because machines have been designed that operate uniformly and are so adjusted as to mix the ingredients thoroughly. Mixing concrete by hand is in most cases more expensive than mixing by machinery, therefore the concrete mixer is continually growing in importance.

Since the concrete mixer has become such an important factor in the construction world, the writer has taken it upon himself to make a study of the different types, and to present in brief form a description of each mixer and its essential parts. The following discussions and data have not been obtained from direct experiment or observation, but have been collected by

studying the catalogues and pamphlets issued by the makers of the mixers.

Early Types of Concrete Mixers.

The first concrete mixer was invented by Frederick Ransome in 1850. The machine was a crude affair consisting of a stationary vertical cylinder with a revolving shaft. It was operated in most cases by horse power, but it is not doubted that steam was also employed. Its construction is indicated in Fig. (a).

Fig. (b) shows the outlines of the next attempt of improving concrete machinery. The cylinder was replaced by a shallower pan, and the straight horizontal arms, by two wheels mounted on a horizontal shaft revolving about the vertical axis. The mixing operation was more efficient than that of the earlier machine, but its usefulness was limited to fine and very wet mixtures.

With the introduction of Portland cement and larger aggregate, came the next change. The old machine would not stand the heavier duty which now fell to its lot, and was replaced by the long inclined hexagonal drum, indicated in Fig. (c). The drum was approximately 35 feet long and 30 inches in diameter. The mixing operation was simply that of rolling contact, and depended for success upon the length of the drum, which was entirely free from deflectors. It was first used in this country in 1875 on the old city hall of San Francisco.

The rapid growth in the use of concrete demanded a type of mixer that would produce a more uniform quality of

concrete. The solution was found in the cubical box mixer with open trunions as shown in Fig. (d). The trunions, originally used only for feeding water into the machine, were later enlarged so as to receive the materials as well. This type of mixer was used for ten years with success. The main objections to it were the height of the feed opening, and the time required to mix, owing to the handling of the batch as a unit. A rocking tendency set up as the load shifted from side to side, and caused excessive wear and tear upon the machine.

The machine indicated in Fig. (e) was the next important development. The original drum was built of wood, and had within a series of fixed mixing blades, together with four removable ones. The removable blades, which laid against the cylinder during the process of mixing, had to be set by hand to a radial position when the mixer was discharged. When so set, they carried the material up high enough to discharge into an inclined chute. The machine was again improved by the addition of a mechanical shifter. See Fig. (f). A steel drum replaced the wooden one, since larger work was being done, and heavier duty fell to the machines.

Another early type and one which is used to-day, modified by improvements, is the gravity mixer invented by Mr. Frank Gilbreth. Having a concrete foundation to lay, it occurred to him to set up an inclined chute leading from the street to the bottom of the excavation, and by means of a series of spikes in the chute, to effect the mixing of the cement and aggregate shovelled in at the top. This experiment proved quite satisfactory and led to the development of the portable gravity

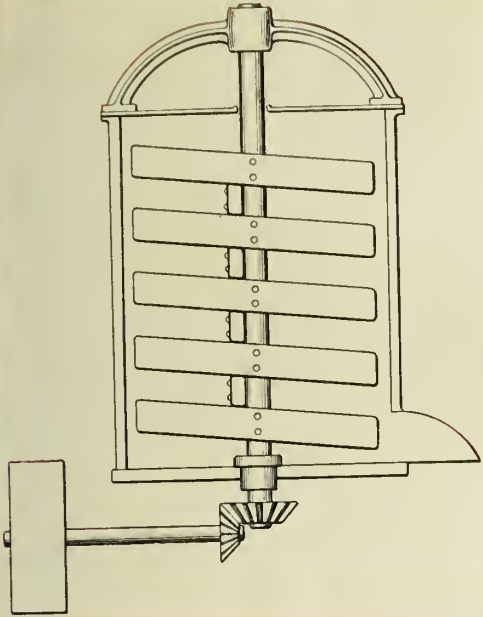

Fig. a.

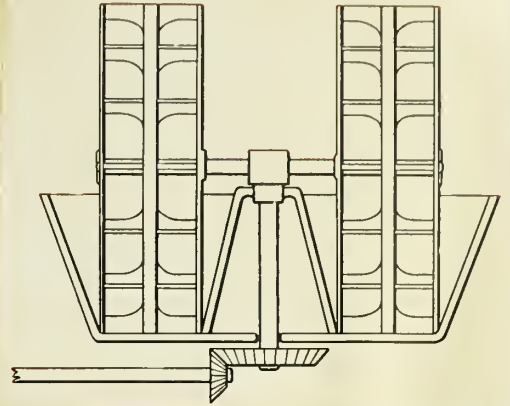

Fig. b.

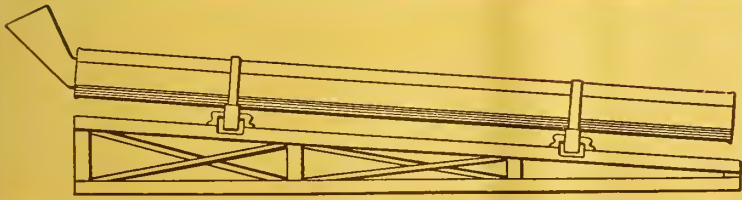

Fig. c.

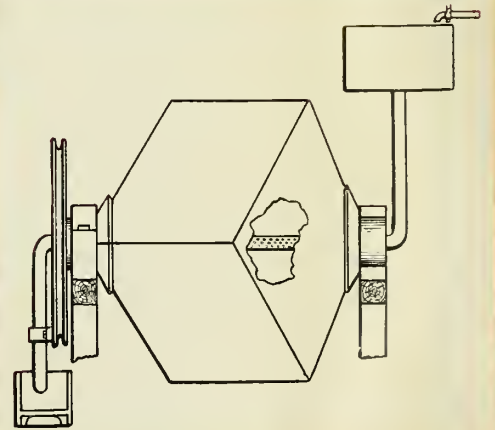

Fig. d.

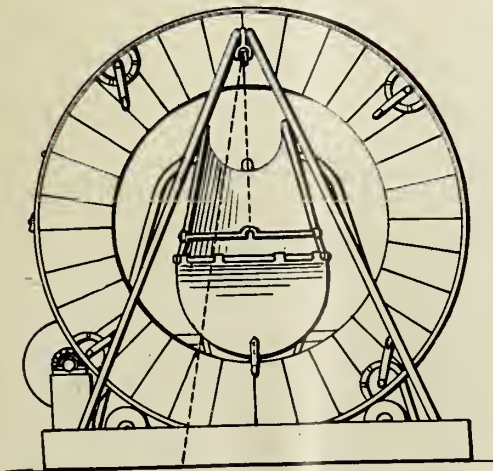

Fig. e.

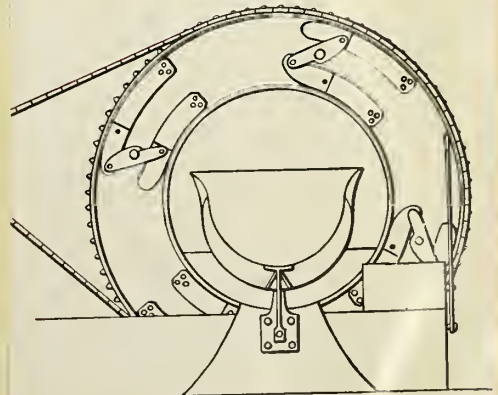

Fig. f.

mixer.

The principal weakness of the early machines lay in their excessive weight, and the large number of parts subject to wear. For example, in the revolving mixers, the chain belt, the movable parts, and the character of the journals, all constituted sources of trouble; one by one they have been altered and eliminated. It was found, too, that the mixing operation was greatly accelerated when the movable blades were set so as to carry the materials to the highest point in the drum. To secure improvement in the mixing qualities, fixed steel scoops replaced the movable shelves; a tilting chute, the old folding one; and a gear and pinion, the chain belt and sprockets.

During the last ten years rapid strides have been made in improving the concrete mixer. These improvements have not only given the machine greater strength, but also have increased the output of the mixer and reduced the number of men necessary for its operation. To give a clearer idea of how concrete mixers perform their work, a general classification and definitions will be given.

Classification of Mixers in General.

Use at the Present Time.

Concrete mixers are divided into two general classes, (1) Continuous Mixers, (2) Batch Mixers. Continuous Mixers are those in which the materials are fed continuously, and from which the concrete is discharged in a steady stream. The continuous mixers may be subdivided into (a) power mixers (these may be horizontal-trough or cylindrical), (b) Gravity mixers, or those in

which the ingredients are mixed by falling through a vertical inclined chute and striking against rods, or by falling against inclined shelves. The power mixers may be further subdivided as to the method of charging and feeding the ingredients.

The batch mixers, or those that are fed and discharged intermittently, may be subdivided according to the method of discharging as, (a) tilting, (b) non-tilting, and also as to the shape, whether revolving drum or cube.

1. The horizontal through continuous mixer consists of a horizontal trough containing a shaft with paddles attached, which revolves about its axis. The paddles are usually shaped so that they force the mixture toward the discharging end of the trough.

The cylindrical continuous mixer consists of a drum that is set at an angle to the horizontal, with its discharging end at the lower elevation. The cylinder is equipped with spokes to which are attached blades, that aid in the mixing. The ingredients are then mixed by being rolled around, the motion being caused by the continuous revolutions of the cylinder itself.

The feeding devices in continuous mixers vary, but the two general types will be described. In one type the bottoms of the hoppers have a reciprocating movement and the proper amount of material, regulated by a slide, is carried forward by the movement of the hopper bottom. In the other type the feed is regulated by a revolving shaft which carries pockets whose volume is of the specified amount. In either type the feeding may or may not be facilitated by agitators. These agitators, when used, usually consist of a worm gear, that revolves in the

hoppers and prevents the material from arching over the out let.

2. The revolving drum batch mixer consists of a hollow drum, the inside of which is equipped with baffle plates or wings of some sort that assist in the mixing.

The cube mixer consists essentially of a cubical box with a hinged door at one corner. A shaft runs through the two opposite corners of the box to transmit power for revolving it. The mixing is brought about by the ingredients being thrown from one side of the box to the other.

The tilting batch mixer is one in which the drum may be tilted by a lever or levers to aid in the discharge; while the non-tilting mixer, as the name implies, is one in which the drum can not be tilted or tipped to aid in the discharge.

Since all types of mixers fall under two main classes or heads, the different makes of each class will be described and explained according to the class to which they belong.

The following list of mixers are considered by the writer to be the best on the market at the present time.

Continuous	Batch
1. Kent	1. Eclipse
2. Besser	2. Koehring
3. S. & S.	3. Cream City
4. Hartwick	4. Polygon
5. Grand	5. Clover Leaf
6. Coltrin	6. Ransome
7. Simplex	7. Marsh Capron
8. Bolte	8. Foote
9. Low Down	9. Chicago
10. Eureka	10. Chain Belt
11. Cockburn	11. Chicago Cube
	12. Cockburn
	13. Northwestern
	14. Milwaukee
	15. Smith
	16. Hains

Description of Individual Continuous Mixers.

The Kent Precision Mixer.

The Kent Precision Mixer is manufactured by the Kent Machine Company at Kent, Ohio. The machine is essentially a trough mixer in which the ingredients are mixed by means of paddles and pushed along the trough at the same time. The mixing trough is so arranged that the paddles are adjustable and detachable. See Fig. 1. The materials are delivered to the mixing trough in small units or measures. These quantities are discharged into the mixing trough at the rate of thirty-five to forty discharges per minute for each material. The sand and cement drop in the same place in the trough so that the dry mixing begins immediately. More than half the entire length of the trough is used for the dry mixing of the sand and cement; thus the dry mix is made absolutely perfect before the stone and water are added. By changing the position of a hand lever which projects beneath the sand hopper, the operator can adjust the distance that the feed plates move and thus govern the amount of each material used. Fig.(1a) and (1b) show views of the feeding device. There are three hoppers; one for cement, one for sand, and one for broken stone. A simple flat plate "B" forms the bottom of the hopper. The hopper remains stationary, but the plate has a horizontal reciprocating movement. At each forward movement, the feed plate carries with it from the hopper a layer of material "E" (see Fig. 1b) equal to the height of the discharge opening through which it passes. At the same time the material in the hopper flows down by gravity evenly, and takes the place



Fig. 1

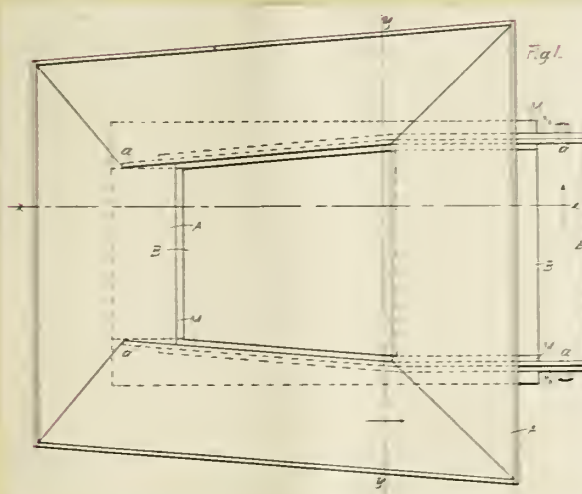

Fig. 1 a.

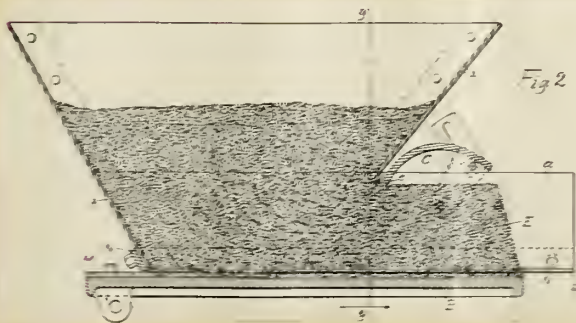
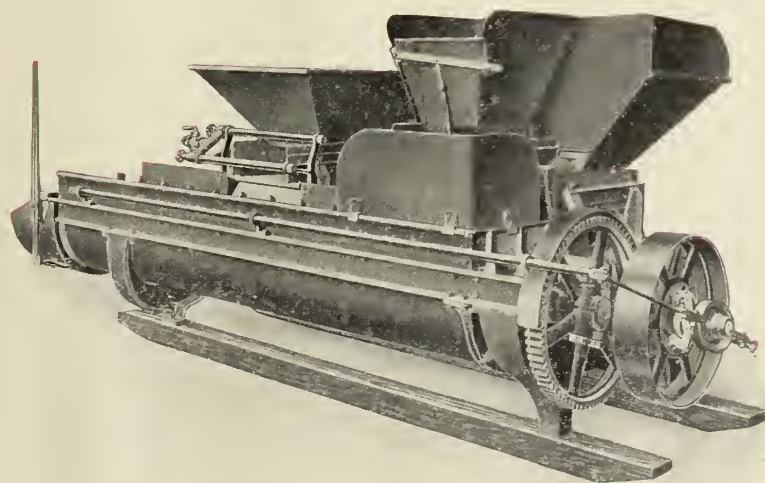

Fig. 1 b.



Fig. 2.



THE "KENT" PRECISION MIXER.

Fig. 3.

of the portion removed. On the return stroke the feed plate is withdrawn from under its burden and allows a layer of material equal to the length of its stroke to fall into the mixing trough. The mixer is driven by spur gearing from the engine and is furnished with a friction clutch for controlling the machine when the engine is in operation. See Figs. 2 and 3.

Weight lbs.	Output Cubic Yards per hour	Cost With Power	Without Power
Without power.			
975	3.5	From \$180.00	
4400	12.5	to \$1100.00	

The Besser Simplex Mixer.

The Besser Mixer is manufactured by the Besser Manufacturing Company at Alpena, Mich. The machine is of the trough type. It has no gears or counter shafts, but is operated by a single chain. This chain is the direct drive from the engine to the main mixer shaft which carries the paddles. The mixer is equipped with either two or three hoppers for handling a corresponding number of different materials. All of the ingredients drop at the same time into the mixing trough. The first two hoppers for sand and cement (See Fig. 4) or any two materials are placed together at the end of the trough. The third, which is usually for stone, is placed by itself about one-third the way down the trough. The receptacles for the ingredients are situated low down to facilitate the charging. The measuring is done by a back and forth movement of a feed beneath the hoppers. At every backward movement of the feed plate the back of the hopper forces a certain amount of material from the plate into the mixing

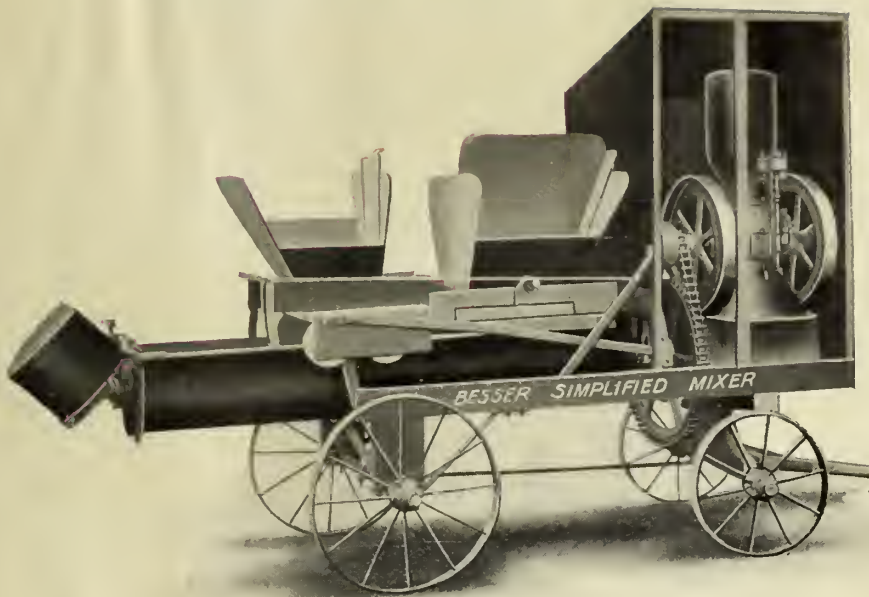

BESSER SIMPLIFIED CONTINUOUS MIXER

On Trucks with Power

Fig. 4.

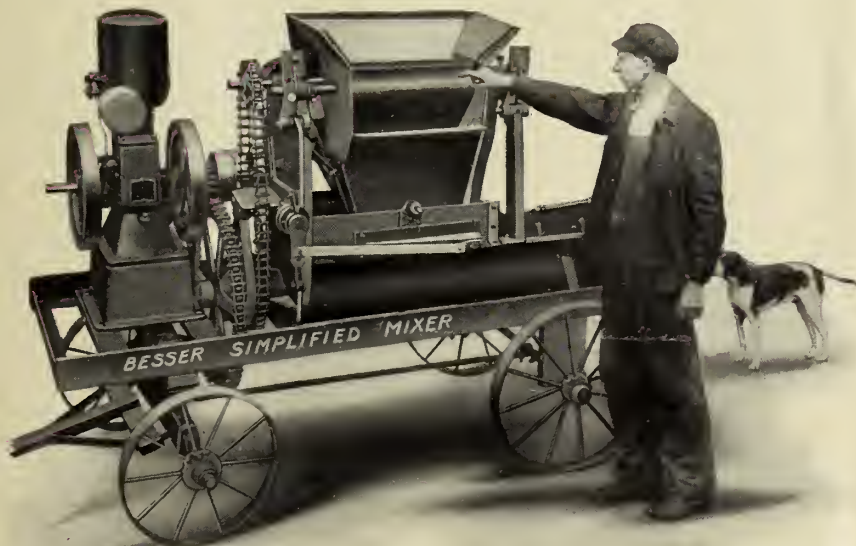

Fig. 5.

trough. This amount can be instantly varied by either changing the length of the stroke or the height of the opening. A short shaft passes through the hoppers for the feeding down of the material. The shaft has arms on it, and, as it rocks back and forth, the material settles down and feeds evenly. The paddles, which have a square hole in them, are strung on the shaft. Thus each paddle is independent, and no screws or bolts are required to hold them in place. The mixing paddles thoroughly stir and mix the material, and at the same time carry it ahead to the discharge end. The material is thoroughly mixed dry for about half the length of the trough; then the water is added by a spray from a perforated pipe controlled by valves. Two levers are used for operation: one of which operates the clutch on the engine and controls the whole machine instantly; the other controls the automatic feeding hoppers without stopping the paddle shaft. For a view of the mixer see Fig. 5.

On skids without power. \$130.00

On trucks with $2\frac{1}{2}$ H.P. engine

Capacity 60 cu. yds. per day. 350.00

On trucks with 5 H.P. engine

Capacity 80-100 cu. yds. per day. 450.00

The S. and S. Elevating Mixer.

The S. and S. Elevating Mixer is manufactured by the Cement Tile Machinery Company at Waterloo, Iowa. This machine is a combination of all good mixer principles. It serves the part of a ^bmatch mixer, a continuous mixer, and also elevates the materials. The materials are measured out by hand; then placed

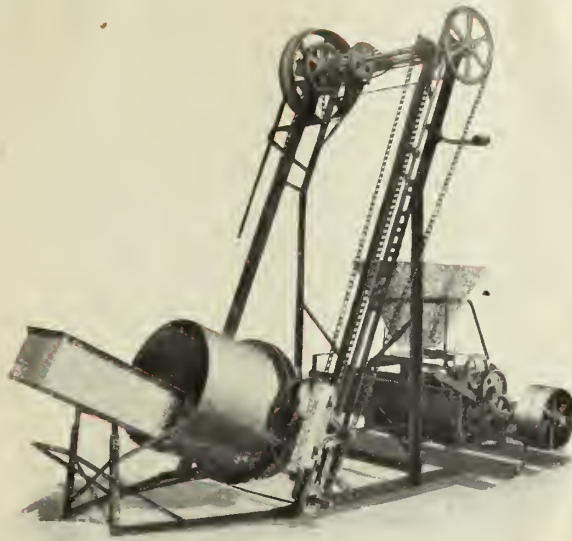

The S & S Elevating Batch
Concrete Mixer

Fig. 6.

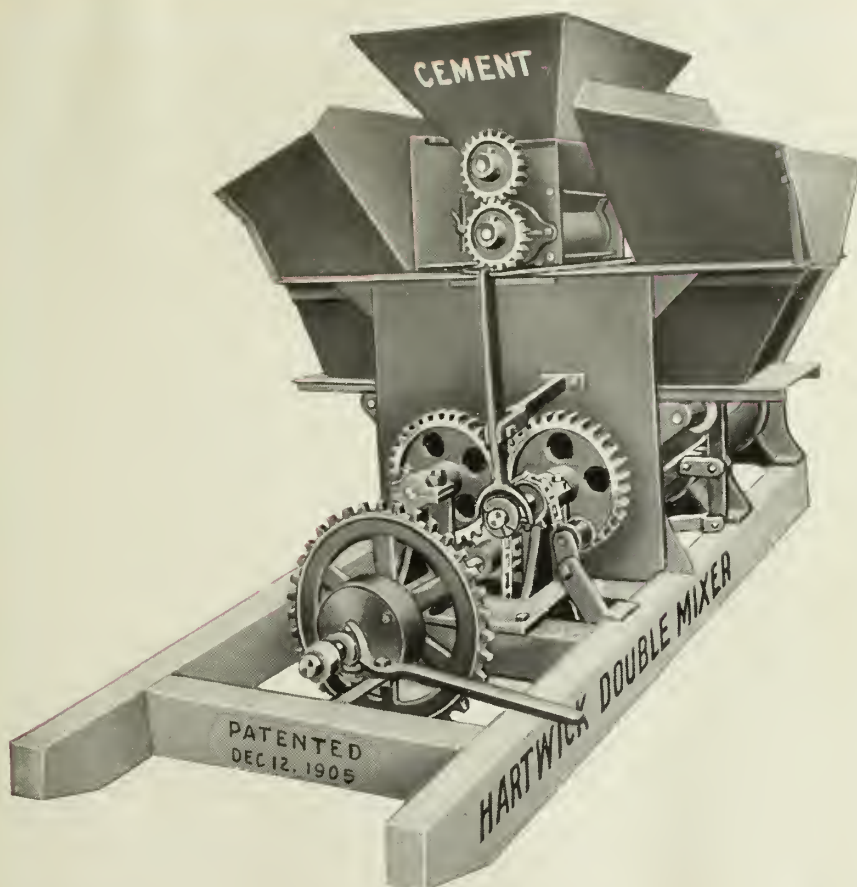

This cut illustrates the HARTWICK Proportioning Mixer on Skids and shows Every Working Part, Including Friction Clutch

Fig. 7.

into a cylinder or drum, and are turned over and over as they are elevated. This is the batch principle. When the cylinder has reached a certain point in its ascent, the materials are discharged into the receiving hopper of the pug mill. From here they are moistened and mixed again and as a final process are discharged in continuous mixer style. For an illustration of the mixer see Fig. 6.

Output cubic yards per day	Cost Machine Complete	Batch and Elevating Chambers
2 - 150	\$450.00	\$300.00

The Hartwick Mixer.

The Hartwick Continuous Mixer is manufactured by the Hall-Holmes Manufacturing Company at Jackson, Mich. There are two general types of these mixers: (a) the double mixing trough, and (b) the single mixing trough. The driving mechanism on all machines is very simple. The machine is driven (see Fig. 7) by two heavy spur gears with pinion and two sprockets. These gears have heavy two and one-half pitch teeth, insuring perfect running and long life. Transmission from engine to mixer is furnished by either chain or gear drive. All bearings are provided with dust proof hard oilers. Machines are provided with a friction clutch on the main drive from the engine which enables the operator to shut down the entire machine without stopping the engine, and prevents breakage in case any large object gets into the machine. The feeders are also provided with a clutch so that the mixing may be continued without running the feeding device. As a result of this arrangement it is not necessary to run out

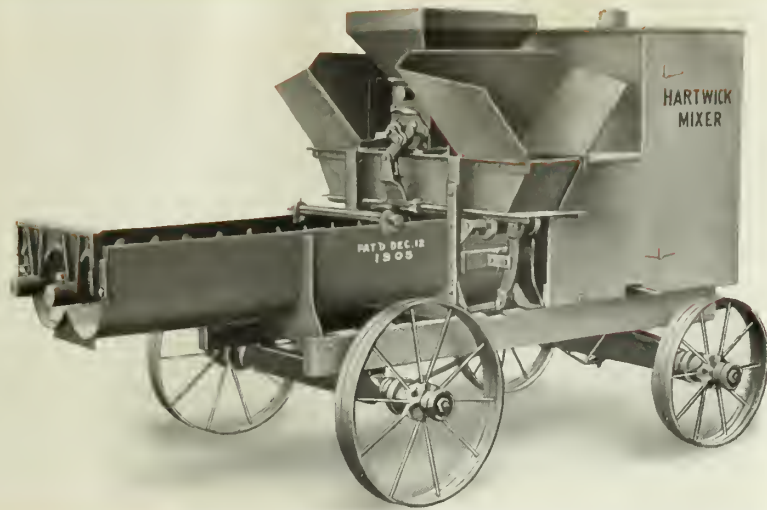
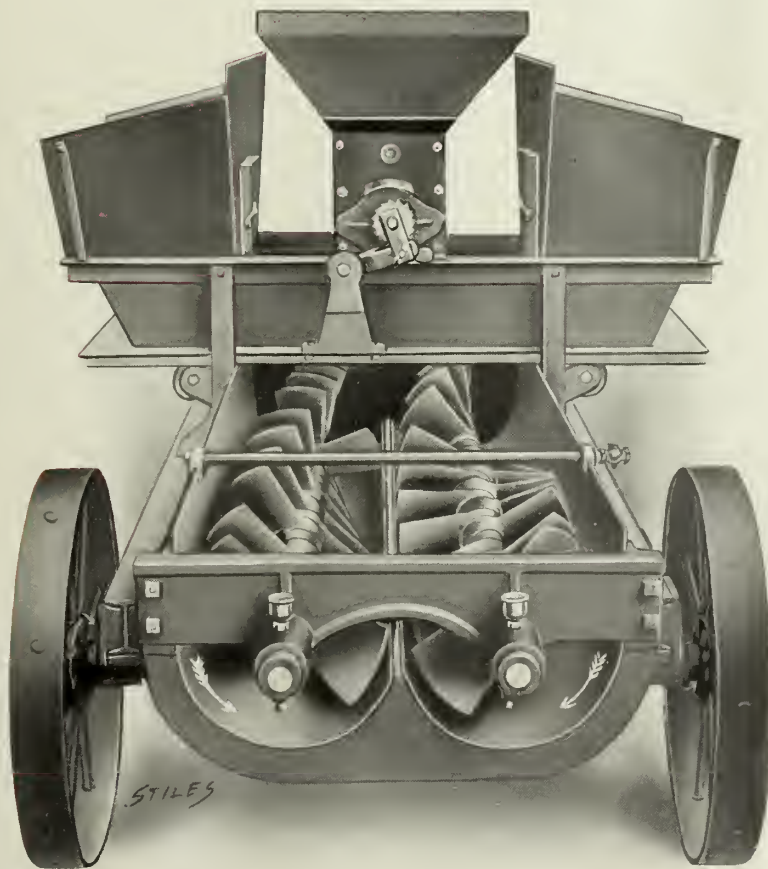

Fig. 8.



This cut illustrates the Double Mixing Trough with two sets of Mixing Flights, used on all Double Mixers. It also shows the three-compartment feeder, made entirely of steel.

Fig. 9.



No. 1 Single Trough HARTWICK

Fig. 10.

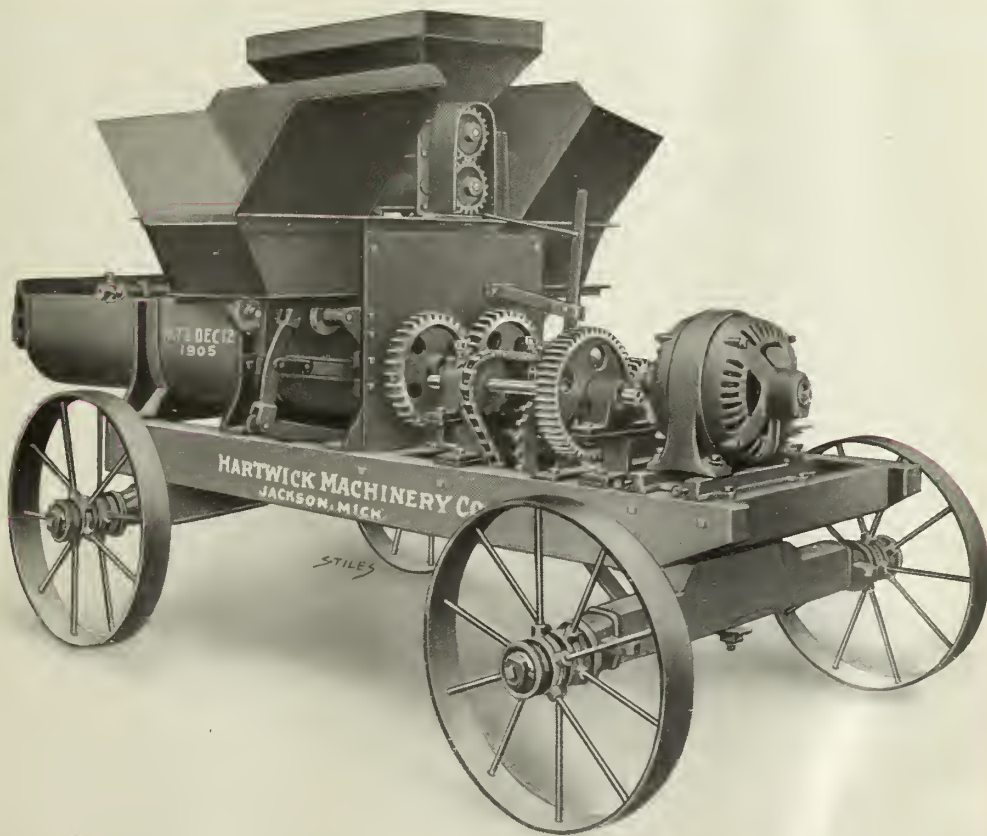

HARTWICK Mixer equipped with Electric Power

Fig. 11.

all the material in the feeding hoppers before cleaning out the mixing trough.

The double trough mixer is shown in Figs. 8 and 9. This trough has two sets of mixing flights which revolve in opposite directions to each other. As the material is discharged from the proportioning hoppers, it drops into the center of the mixing trough and is passed the entire length of the same. The proportioning feeders consist of three compartments set crosswise to the mixing trough. The two outside compartments are for any and all kinds of material up to five inches in diameter; the middle one, for cement only. The two outside compartments, into which the coarse materials are fed, proportion the ingredients by means of a reciprocating plate which forms the bottom of the hopper. The front end of the hopper has an opening 6 inches high, thus leaving an outlet or discharge for material. The opening is made large or small by raising or lowering a heavy steel plate, by which the different proportions are attained as well as varying the output of the material to suit requirements. The cement proportions are obtained by means of a rotary cup feed over which is placed a steel slide. By changing the position of the slide any desired proportion can be fed. There is also an agitator in the cement bin which prevents arching of the cement and gives a force feed.

The single trough mixer is essentially the same as the double trough, except, as the name signifies, there is but one mixing trough. The working parts and feeding device are the same as before described. The hoppers are 4 feet above ground level and the discharge end 2 feet, giving ample room for use of wheel-



No. 1 Grand

Fig. 12.

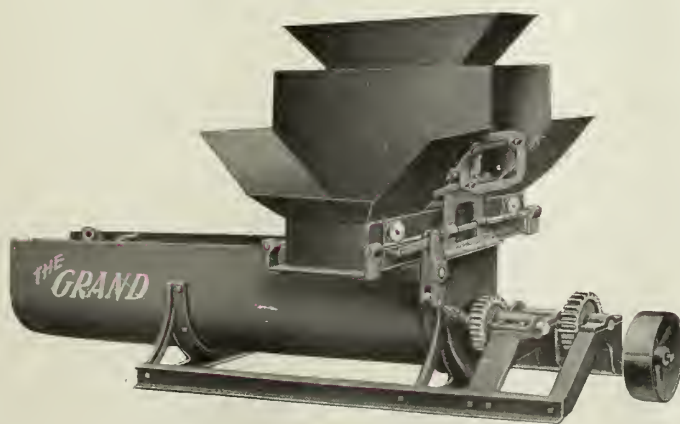

The GRAND on Skids



Fig. 13.

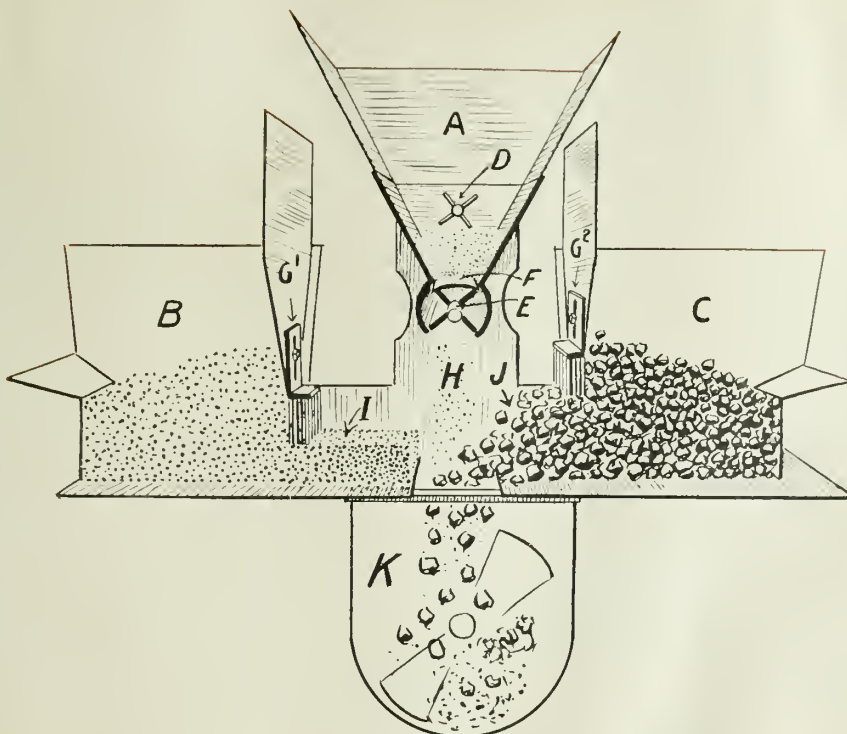

Sectional View of Feeding Device of the GRAND

Fig. 1A.

barrows. See Figs. 10 and 11 for views of the mixer.

Either machine can be equipped with gasoline, steam, or electric power.

Weight lbs. Without power	Output cubic yards per hour	Cost	
		With power	Without power
3150	5	\$375.00	\$275.00
2850	15	\$850.00	\$450.00

The Grand Mixer.

The Grand Mixer is manufactured by the Hall-Holmes Manufacturing Company at Jackson, Mich. This mixer has a single trough. The power transmission on the machine is by gears only, which, together with the engine, are nicely housed-in to protect them from dust and dirt. See Figs. 12-13. A friction clutch is also arranged on a counter shaft which is easily accessible. The mixing trough, in which the blades operate, is between 6 and 7 feet in length. The feeding device of this mixer is shown in Fig. 14. As hoppers (b) and (c) move backward, the material that is thrown into hopper (b) is forced toward the mixing trough at one move of the hopper, shoving charge (i) off and at the same time "striking off" charge (j). At the next movement charge (j) is shoved off into the mixing trough, and charge (i) is struck off. The amount of these charges is determined by the height of the brushes or gates (g-1) and (g-2), which are adjustable. By looking at the figure it will be noticed that the materials receive a brief gravity mix before entering the trough.

The machine can be fed from either side or both sides at the same time, which makes it easier and more economical than where it is necessary to feed the machine from one particular

side. The machines are equipped with either steam or gasoline engines.

Weight lbs. without power	Output cubic yards per hour	Cost	
		With power	Without power
650	4	\$275.00	\$215.00
2250	15	\$800.00	\$475.00

The Coltrin Mixer.

The Coltrin Mixer is manufactured by the Knickerbocker Company at Jackson, Michigan. The mixing is done in a steel shell with the bottom rolled to the shape of a half cone. The shell is 5 feet long and is equipped with revolving blades $1\frac{1}{2}$ inches wide; these extend on a spiral from head to foot of the machine where the mixture is discharged. The concrete is cut through and turned over eight times at every revolution of the mixing cylinder, which revolves thirty times per minute. The material is thoroughly mixed before wetting. The mixing is continuous while the machine is in operation, and the material, when once put into the shell, cannot be discharged without mixing, since it travels the length of the mixing shell. The feed device has three pockets for automatically proportioning broken stone, sand, and cement, or gravel and cement; and the proportioning works without the use of gears, sprockets, or chains. A pitman on the drive end of the cylinder shaft works by a connecting rod with a crank arm on loose bearing attached to a $1\frac{1}{2}$ inch square shaft which forms half of a jaw clutch. The other half clutch is a sliding collar operated by a lever for throwing the feed in or out, leaving the mixing parts in operation if desired. The square shaft extends through the hopper body, and its use does away with all keys and

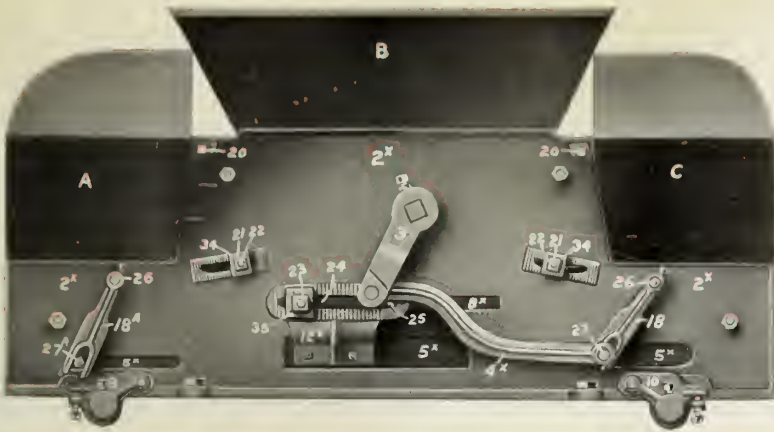
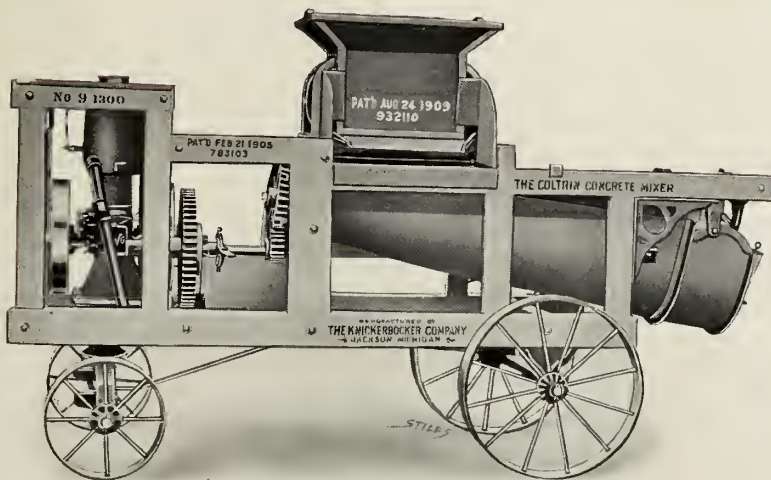

Fig. 15.



Fig. 16.



No. 9 Coltrin Concrete Mixer

Fig. 17.



No. 12 Coltrin, rear view

Fig. 19.

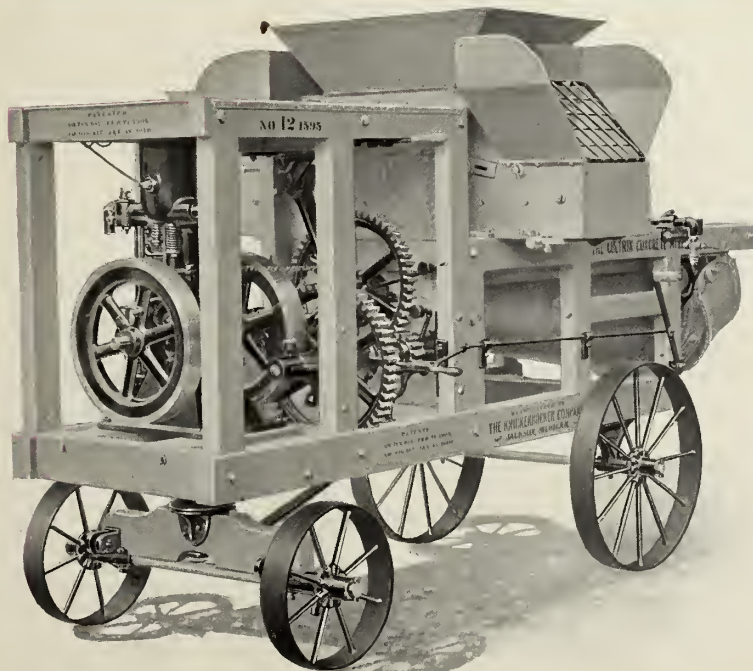

No. 12 Coltrin, front view

Fig. 20.



their liability of working loose. This arrangement gives a reciprocating action to the feeder, one pocket emptying while the opposite pocket is filling. The same mechanism controls the cement pocket and feed. See Fig. 15.

This type of mixer has a very ingenious device for preventing the cement from arching over the outlet. See Fig. 16. The shovelful strikes the plate in front of the cement hopper causing the plate to go down, turning the feed roll, and lifting out one pocket of cement on the shovelful of sand, gravel, or stone. Thus with each trip of the feed plate the back of the cement hopper is jarred, preventing any bridging of cement. For views of the mixer, see Figs. 17, 19, 20.

Weight lbs. Without power	Output cubic yards per hour	Cost	
		With power	Without power
1200	3	\$250.00	\$140.00
3600	20	\$600.00	\$425.00

The Simplex Mixer.

The Simplex Mixer is manufactured by the Miles Manufacturing Company at Jackson, Michigan. The machine is equipped with a three-part hopper which enables the operator to feed either sand, gravel, or stone from either or both sides. The materials are not only mixed by the aid of gravity, but are carried to the discharge end in like manner. See Fig. 21. The mixing drum is set at an angle so that each revolution the materials are carried about 2 inches toward the discharge end, and as the drum is 60 inches long, this means that the materials are turned and mixed thirty times before delivery into the wheelbarrow. The materials are all thoroughly mixed dry in the upper

end of the drum, and the water is not added to the mix until the last 18 inches. On the inside of the mixing drum there are steel blades $1\frac{1}{4}$ inches high that carry the material well toward the top of the drum, before it is rolled back. The regulation of the water supply is under the control of the operator at all times. The entire feed of the materials is controlled by a spiral jawed clutch lever. By the throwing of this lever, the mixing of the three materials is stopped, but the mixing drum is allowed to continue revolving until it is entirely emptied. The feed is controlled by means of an individual clutch, and it may be stopped or started regardless of the rest of the machine. If it is desired to empty the drum, the feed may be stopped, while the balance of the mixer continues until the materials are all discharged. See Figs. 23-24.

- A a very heavy chain.
- B malleable scraper links.
- c " " "
- D $1\frac{1}{4}$ \emptyset shaft for idle sprockets.
- E idle sprockets for sand chain.
- F idle sprockets for cement chain.
- G $1\frac{1}{4}$ inch square shaft for drive sprockets.
- H 24 tooth sprocket driving feed.
- K cement slide.
- J steel brushes for sand and stone.
- M Proportioning cam for sand or gravel.
- N Proportioning cam for cement.
- O Proportioning cam for stone or sand.
- P slotted slide for holding proportioning cam.

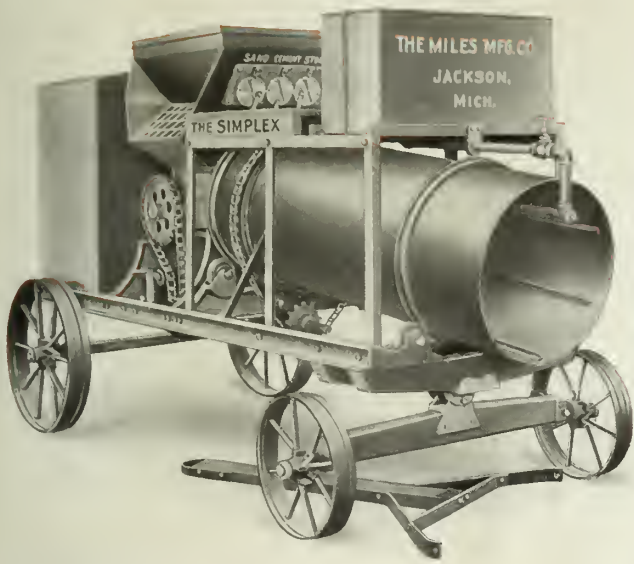

Fig. 21.

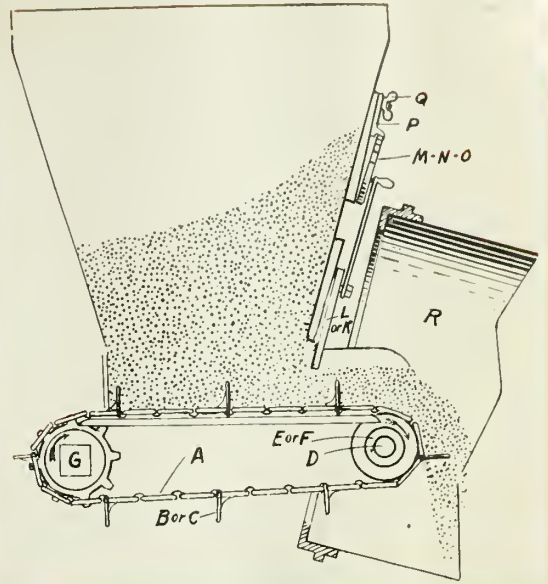

Fig. 23.

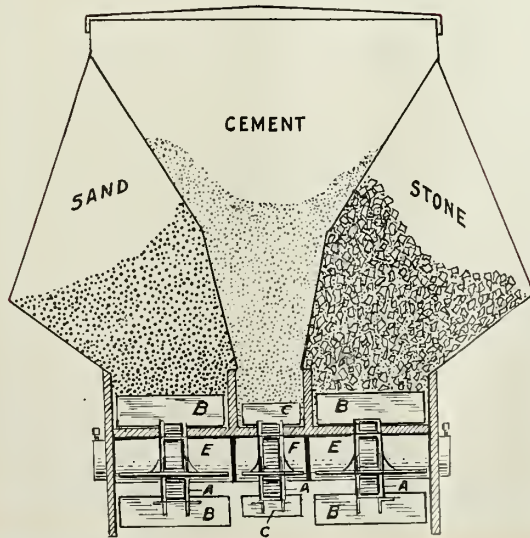

Fig. 24.

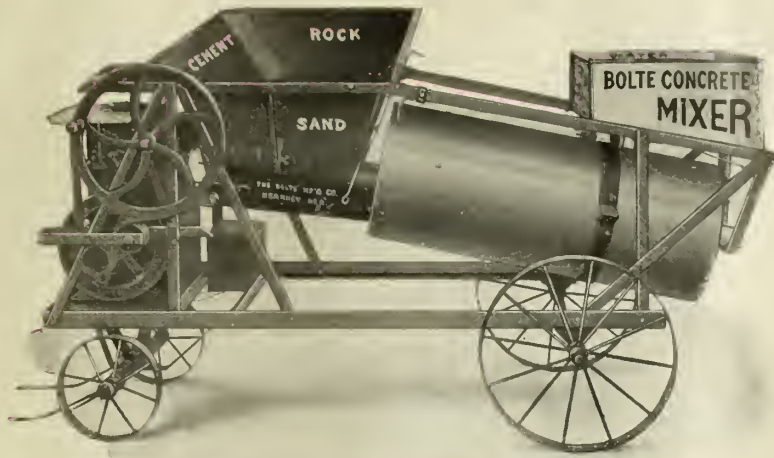

Fig. 25.

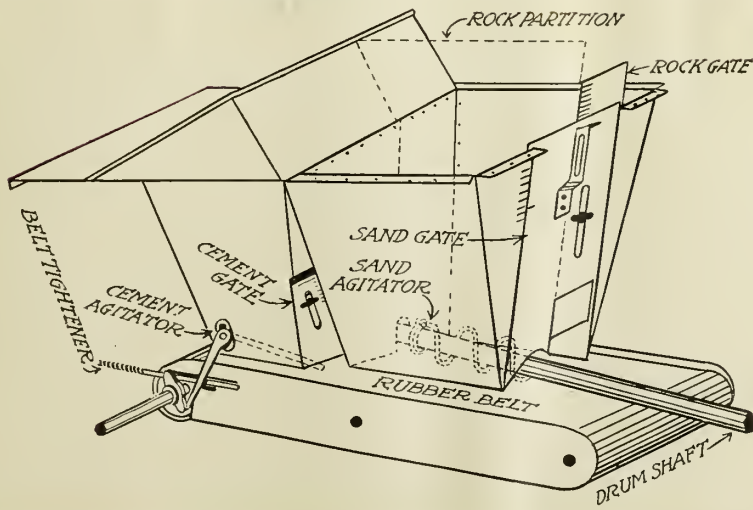

Fig. 26.

Q locknut for doubly locking proportions.

R short section of mixing drum.

Weight lbs. Without power	Output cubic yards per hour	Cost	
		With Power	Without Power
1500	7	\$315.00	\$245.00
2000	10	\$350.00	\$275.00

The Bolte Mixer.

The Bolte Mixer is manufactured by the Bolte Manufacturing Company at Kearney, Neb. This mixer is of the inclined cylinder type. See Fig. 25. This machine can be operated either by hand or engine power, as conditions may demand. The measuring device consists of tandem hoppers placed over a conveyor or feed belt which forms the bottom of the hoppers. See Fig. 26. This conveyor belt draws all materials in a uniform and constant stream through adjustable gates which are set for any required proportions. The materials are conveyed from the different hoppers by the feed or conveyor belt, and discharged into the upper end of the revolving mixing drum, which is equipped with mixing blades diagonally bolted to drum spokes. The drum catches the materials, and constantly rolls them over and over. This process of constant rolling is repeated many times until there is a thoroughly uniform dry mix before adding the water to the mixed materials. The wetting of the materials is done with a perforated pipe extending 15 inches into the rear end of the drum. The manner in which the drum is constructed gives vibration throughout; the mixing blades, six in number, are fastened at both ends to the drum spokes, having a lateral spring-like action which prevents the materials from adhering to the inside of the

drum. Any material inclined to stick to the drum may be released by the use of an automatic hammer.

Weight lbs. Without power	Output cubic yards per hour	Cost	
		With power	Without power
500	5	- - -	\$140.00
600	6	- - -	\$160.00
900	10	\$250.00	- -

The Low Down Forced Feed Mixer.

The Low Down Forced Feed Mixer is manufactured by the Elite Manufacturing Company at Ashland, Ohio. The special features of the mixer are that the hoppers are close to the surface of the ground, and that the chain elevator acts as a force feed, forcing the stone, sand, and cement, wet or dry, into the mixing trough. Again, the operator can see at all times whether or not the feeding is taking place and, as the chains pass through the entire length of the hoppers, no clogging is brought about. The gates at the end of the hoppers are separate, and each one can be regulated to the mixture or quantity desired. The mixing trough is sufficiently long to give the material a thorough mix. Water is sprayed from a pipe fed either by barrel or city pressure; the flow can be regulated to suit the operator. The mixing paddles are made of the best malleable steel and are mounted on a shaft directly connected to the gears. Fig. 27 shows a view of the mixing arrangement of the machine; the feed belts are at right angles to the mixing trough. Figs. 28-29 show views of the supply hoppers and their discharge ends. Fig. 30 shows a sectional view and the position of the hoppers and chain elevators. Fig. 31 shows a view of the mixer in

PATENT PENDING

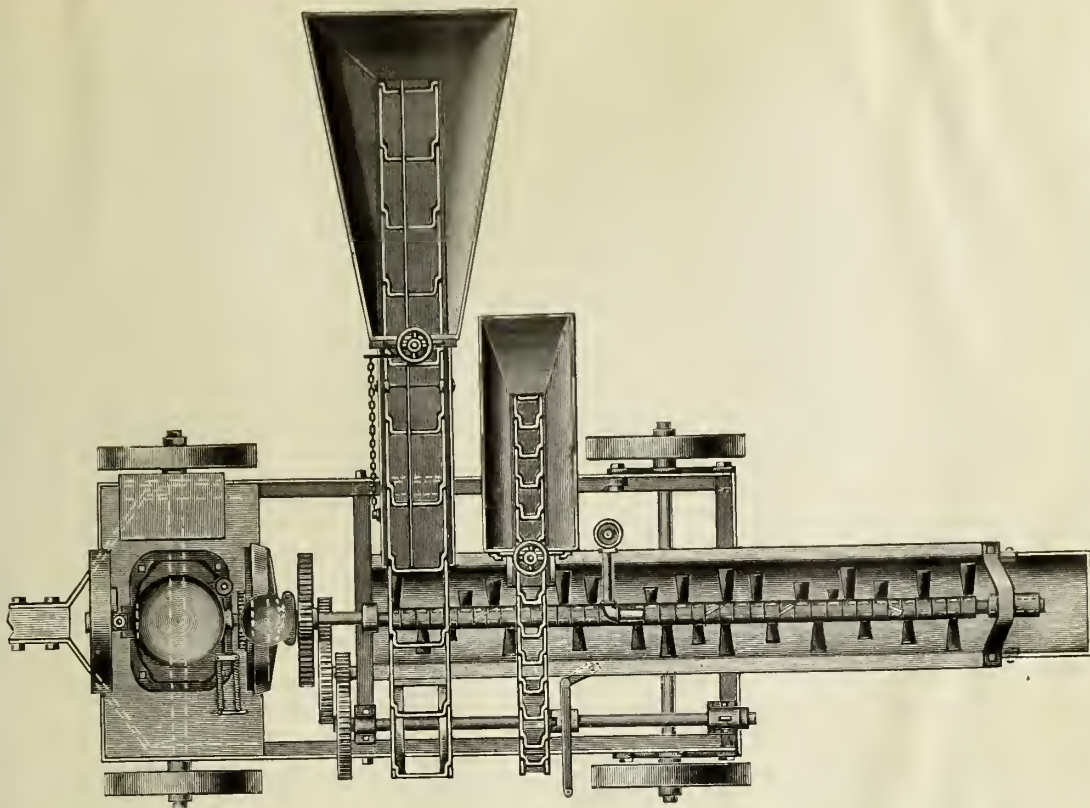

Fig. II. Top View of the Machine

Fig. 27

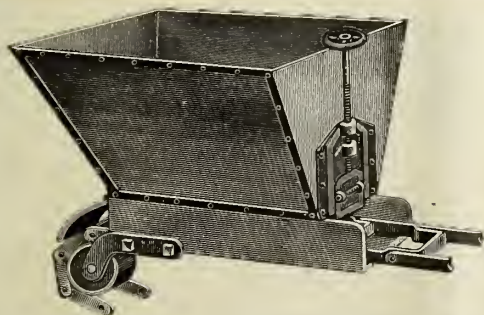
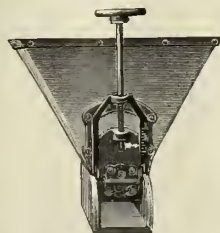

Fig. III. Cement Hopper



End View

Fig. 28.

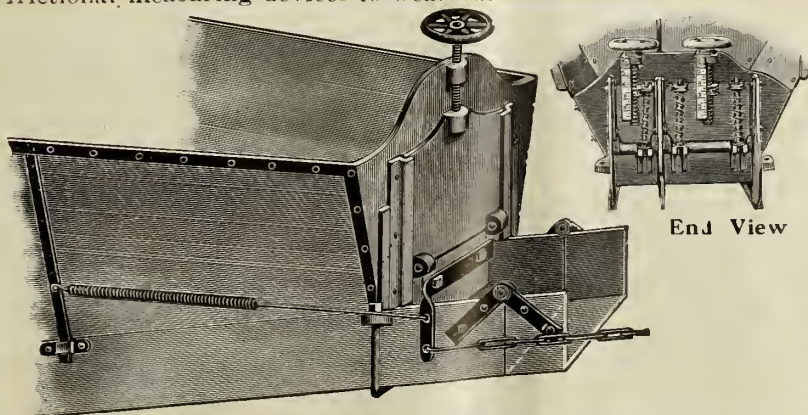

Fig. IV. Large Sand and Stone Hopper

End View

Fig. 29.

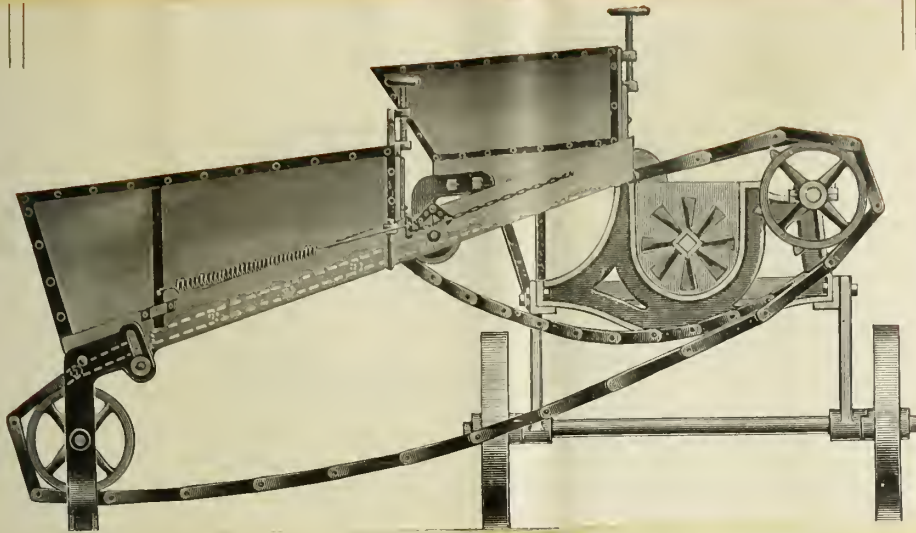

Fig. 30.

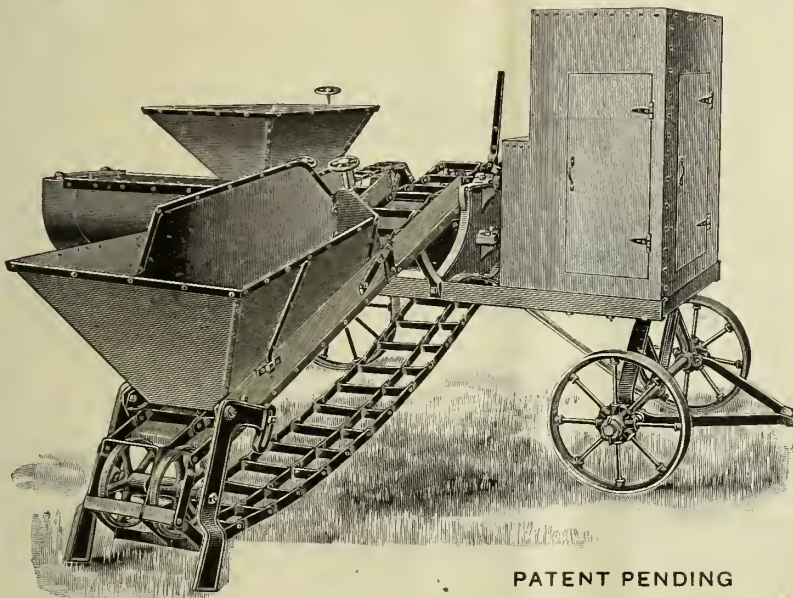

Fig. 31.

PATENT PENDING

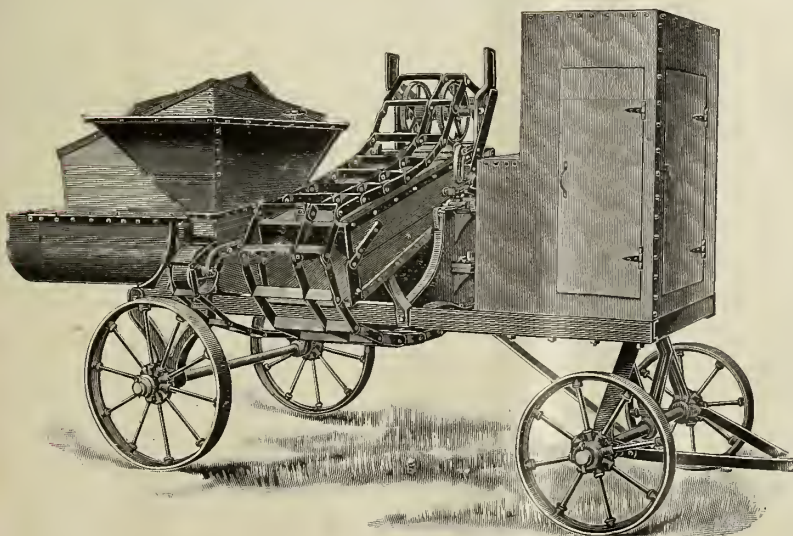

Fig. 32.

Machine Folded Ready to Move

operation and Fig. 32 shows the machine ready to move. A three horse power water jacket engine furnishes power.

Weight lbs.	Cost	
With power	With power	Without power
2300	\$400.00	\$275.00

The Eureka Mixer.

The Eureka Mixer is manufactured by the Eureka Machine Company at Lansing, Michigan. This mixer is of the trough type. The feeding device consists of feeders that revolve and carry with them a certain amount of material at each revolution. See Fig. 33. Rolls above these feeders serve to keep the pockets even full of material, and at the same time provide enough flexibility to allow any foreign substance to pass without damage. A worm agitator in the sand bin keeps the sand and gravel moving, thus keeping the damp sand from bridging over the feeders. Proportioning plates, which are numbered to correspond with the numbers on the proportioning card, are furnished with each machine. The mixing is to some degree accomplished as the materials fall together from the feeders into the mixing trough. The material is here taken up by thirty-six specially designed mixing blades; first thoroughly mixed in its dry state; then wet and thoroughly mixed again and discharged. See Fig. 34. The drive is a belt with automatic idler. See Fig. 35. For other views of the machine see Fig. 36. The machine may be equipped with either gasoline, steam or electric power.

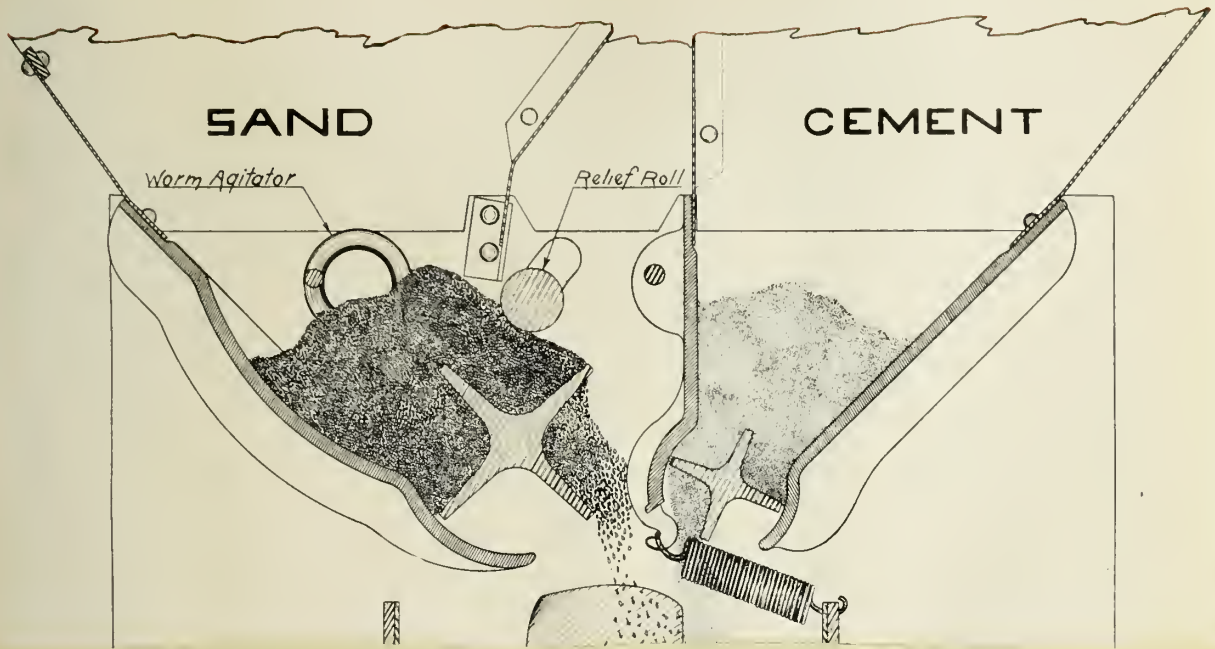
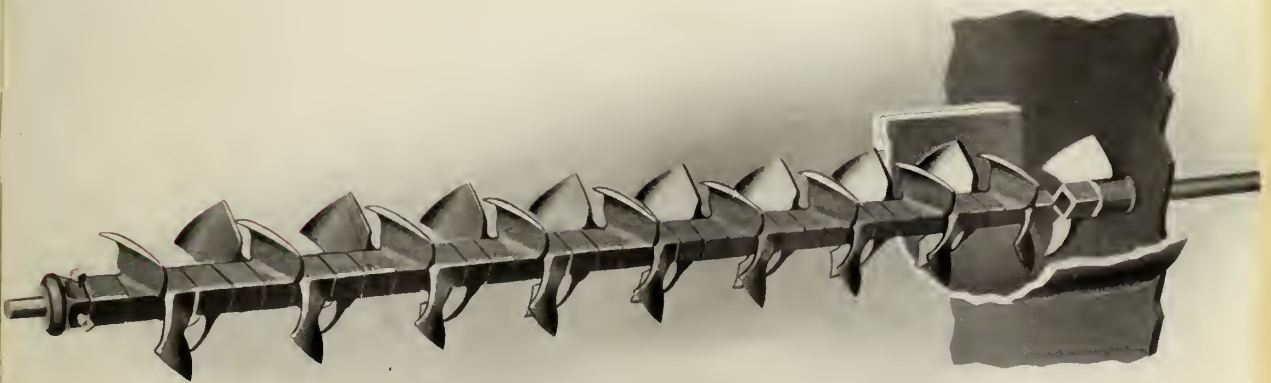
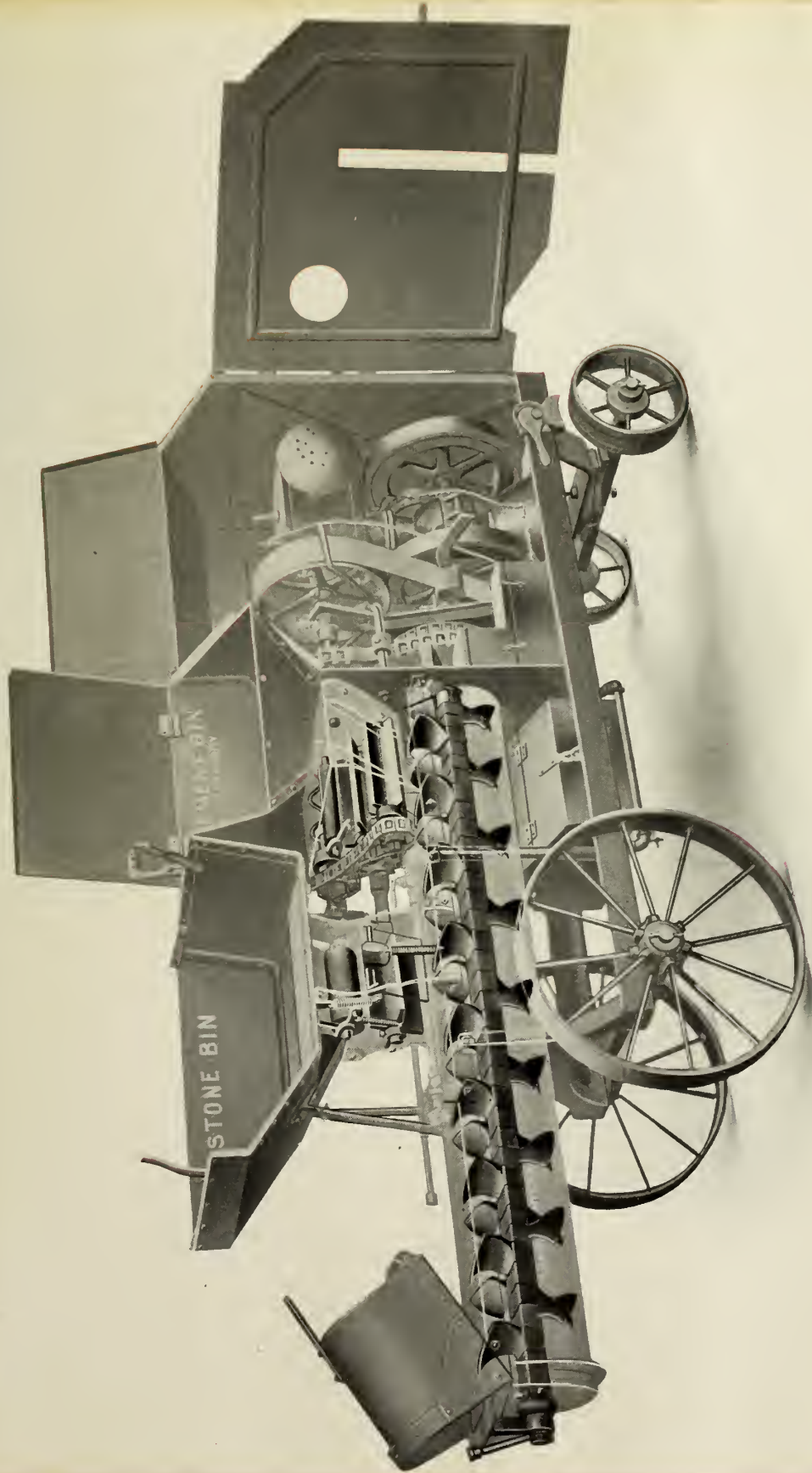

Fig. 33.



REMOVABLE MIXING SHAFT WITH BLADES

Fig. 34.



SECTIONAL VIEW OF EUREKA No. 83 EQUIPMENT

FIG. 35.

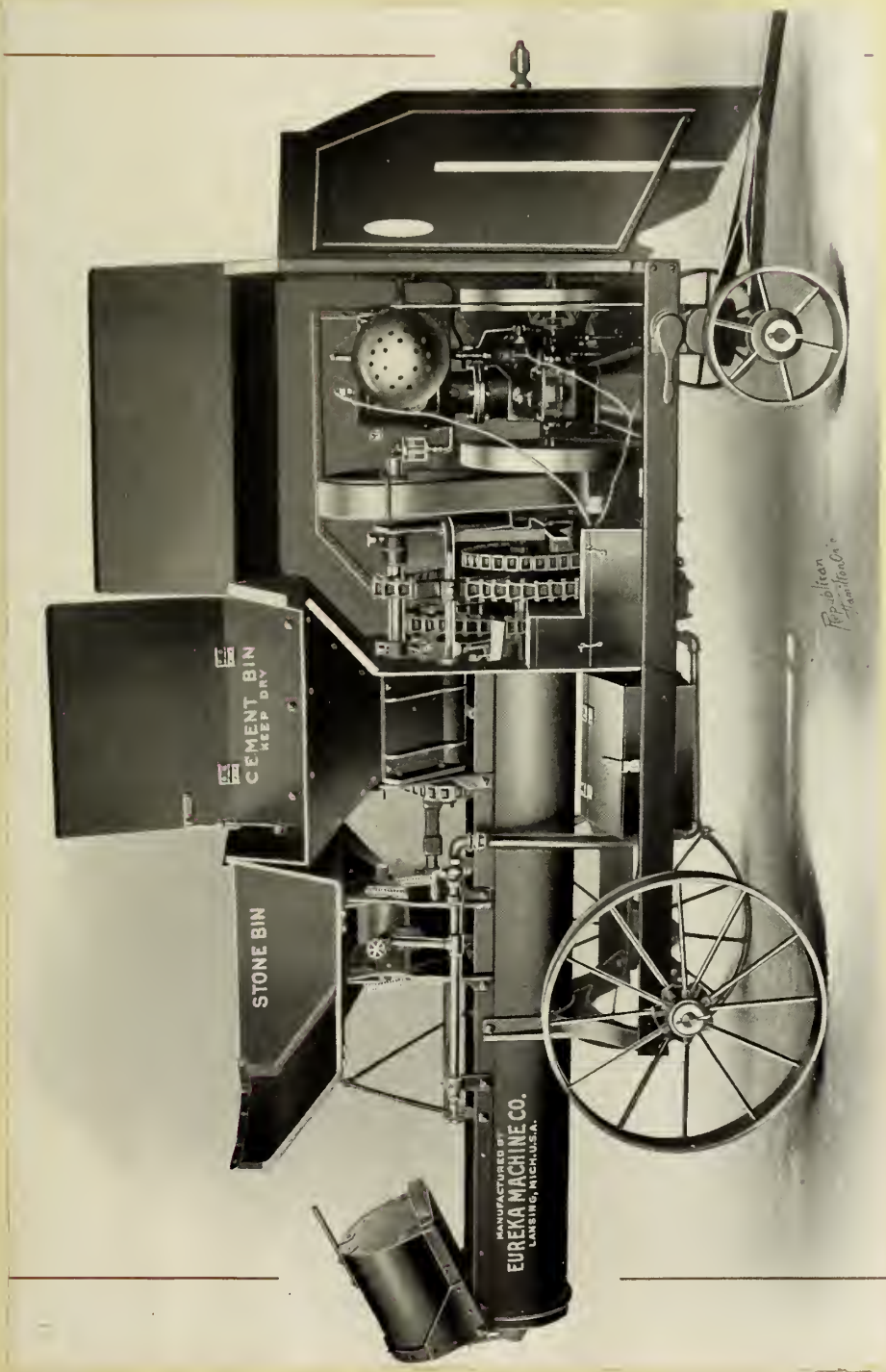

Fig. 36.

Weight lbs. Without power	Output cubic yards per hour	Cost With power	Cost Without power
1200	8 - 10	\$600.00	\$525.00
3000	12 - 15	\$740.00	\$650.00

The Cockburn Mixer.

The Cockburn Mixer is manufactured by the Cockburn Barrow and Machine Company at Jersey City, N.J. This mixer has no automatic measuring device; the materials are shovelled into a single hopper in the proper proportions. Around the top of the hopper a platform is usually built upon which the materials are dumped. The materials are fed into a rectangular tumbling mixing box by a worm screw. The tumbling box is on a slight incline from the hopper, and this fall, together with the pushing of the worm screw, is sufficient to give a steady yield of concrete at the discharge end. Water is admitted to the tumbling box by a one inch pipe from which it is sprayed. For a view of the mixer see Fig. 36(a).

Capacity cubic yards per hour 25-30	Cost with power \$1150.00
--	---------------------------------

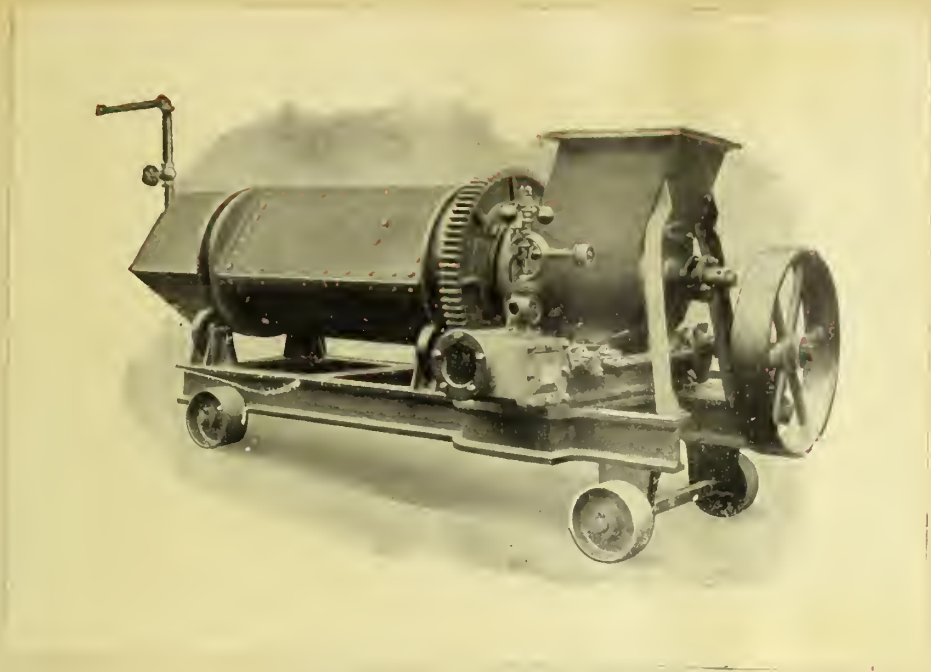

Fig. 36 a.



Eclipse Concrete Mixer

Fig. 37.

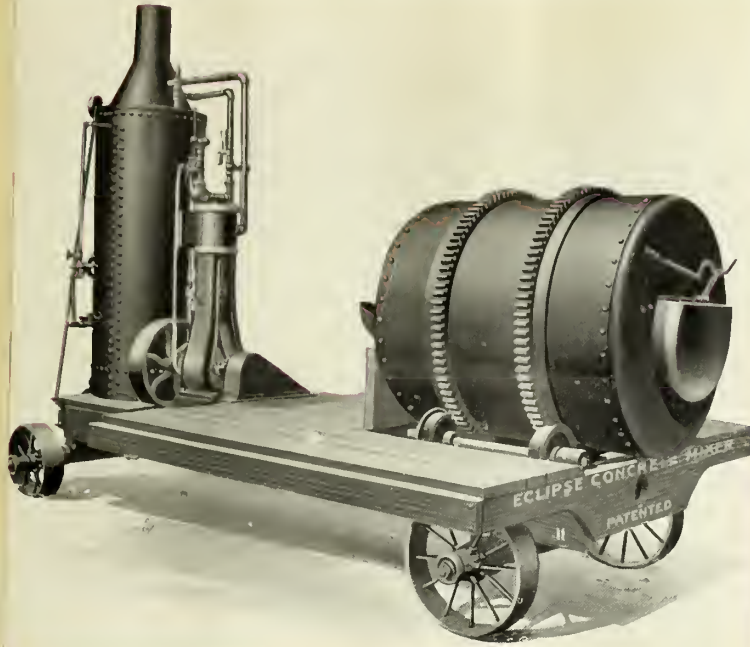
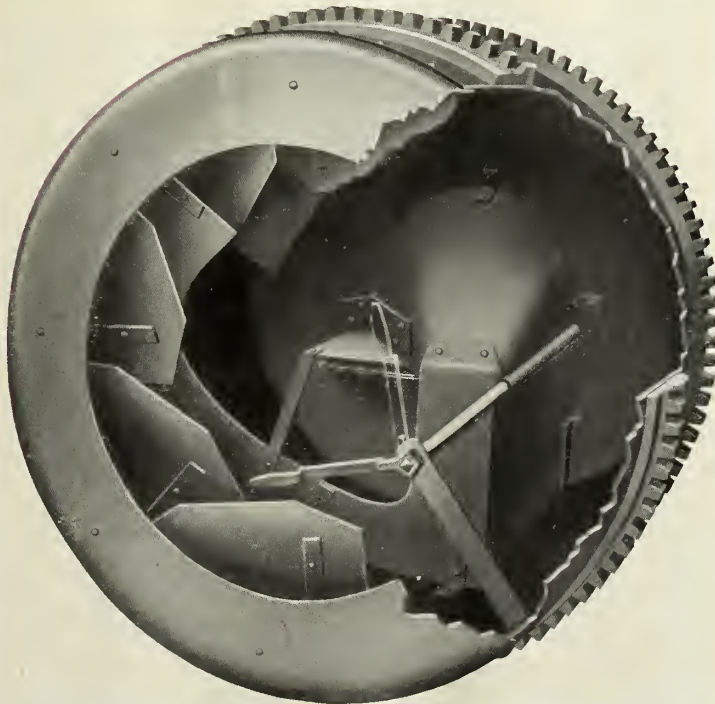

Fig. 38.



Cut-away View showing Details of Construction of the "Eclipse" Drum.

Fig. 39.

Individual Batch Mixers.

The Eclipse Mixer.

The Eclipse concrete mixer is manufactured by the Standard Scale and Supply Company. The mixer consists of a revolving drum into which the material is charged directly from the wheel barrow. The material to be mixed is wheeled upon a low platform, which is portable with the outfit, and there charged into the drum. See Fig. 37.

The drum is supported by trunion rollers which tread against the flare of the track bands. It is rotated by gears meshing into the gear bands, the power being transmitted through the shaft to which these gears are attached. See Fig. 38. In the interior of the drum are diagonal mixing blades (see Fig. 39) which are firmly attached to the drum and rotate with it. The blades are placed in an inclined position in such a way as to throw the material to the sides where it is acted upon by other blades. One of these blades is made low, and extends from the charging end diagonally to the discharging pocket which is shown in the rear end of the drum. See Fig. 39. A discharge chute extends into the drum through the head at the discharging end. A shaft extends through the drum near the chute on which is mounted a door that is held over the opening to the chute when mixing. When ready to discharge, the shaft carrying the door is turned by the lever at either end so that the door drops down closing the space between the head at the discharging end and a blade parallel with the head at the inner edge of the door, thus forming a pocket which grinds the mixed concrete into the dis-

charge chute.

In charging the drum it is preferable to put water in first, then a barrow of stone or gravel to be followed with a barrow of sand. The cement can be placed in on top of the sand, and both dumped together if desired. A final barrow of stone follows the sand and cement. By charging the mixer in this manner it is only necessary to rotate the drum two or three revolutions after the last barrow of material is delivered to the drum, before the batch is ready for discharging. This is due to the fact that the finer materials are being mixed during the process of charging, and it is only necessary to thoroughly mingle the last barrow load with the other material.

The door may be thrown open for discharging and left open until the entire batch is discharged or, the door may be closed after a barrow of concrete is discharged and allowed to remain closed until another barrow is ready to receive its discharge. This discharge door is opened or closed by a lever at the will of the operator. Under ordinary conditions a batch of concrete can be discharged once a minute. Fig. 40 shows a view of the mixer in operation upon track work.

Weight lbs. Without power	Output cubic yards per hour	Cost With power	Without power
700	3	\$410.00	\$325.00
4600	30	\$1000.00	\$860.00

The Koehring Mixer.

The Koehring Mixer is manufactured by the Koehring Company at Milwaukee, Wisconsin. The mixer is of the ordinary drum type and does not tilt to discharge.



Equipped with Batch Hopper Bu

Fig. 41.



Illustration showing the Eclipse Mixer on Street Railway Work. The long trough is used to convey concrete over the tracks and is swung to one side for cars to pass.

Fig. 40.

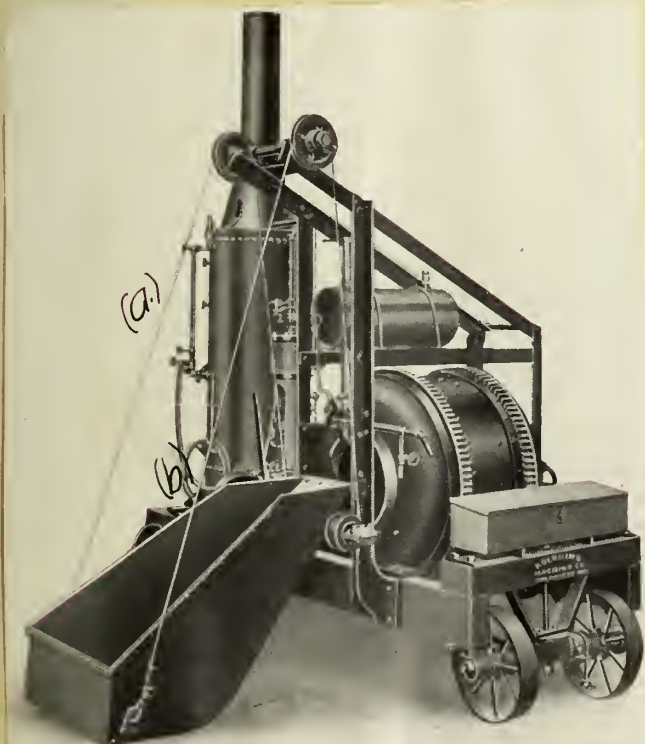

Fig. 42.



Sectional View of Drum.

Fig. 43.

The charging is either accomplished by dumping the ingredients into a batch hopper bin (see Fig. 41) or by the use of an elevating charging bucket. (see Fig. 42) In the first case an elevated platform is necessary to form a runway for the barrows; in the second case the material is dumped directly into the charging bucket. The bucket can be filled while the batch is being discharged from the drum. As soon as the drum is empty, the bucket is hoisted into a discharging position, and the entire batch is emptied into the drum. It requires only about five seconds to elevate the discharging bucket, so there is only a few seconds interval from the time the batch is discharged from the drum until another complete batch is dumped into it. In Fig. 42, (a) and (b) are two wire cables fastened to the two outer corners of the bucket from where they pass over sheaves to the winding drums. The drums are keyed on to a shaft which is driven by gearing from the main driving shaft. The bucket is easily raised and lowered by means of a friction clutch lever.

Fig. 43 shows a sectional view of the mixing drum. The mixing action caused by the rounding edges is important, since the material, when breaking away from the inner walls of the drum, falls towards the middle. The mixing blades are placed at an angle with the axis of the drum (see Fig. 43) leaving clearance between the end of each blade and the head of the drum; this prevents pocketing of material. The blades are so arranged that they carry the material alternately from end to end of the drum and break it over against the heavy heads.

The inner end of the discharge spout (see Fig. 43), when not in discharging position, is tilted downward. Material

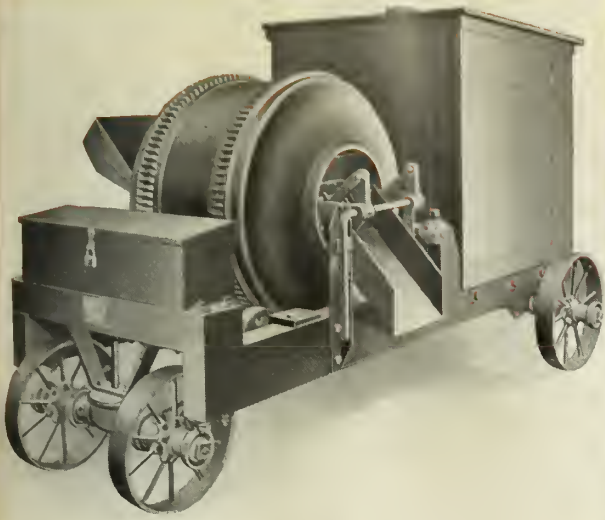

Equipped with Gasoline Engine.

Fig. 44.



Fig. 45.



Fig. 46.

carried upward by the mixing scoops falls on this spout, and then is deposited in a constant sheet or flow to the bottom. Here it strikes at right angles to that from the lifting and pouring action from the sides, and the flow of material from the end to end mixing.

The discharge chute (See Fig. 44) is made in two segments and is sufficiently high from the ground so that the ordinary wheelbarrow can pass underneath it. The section outside the drum is stationary. The section inside tilts upwards when the material is not wanted, and is controlled by a lever. To discharge the contents from the drum it is only necessary to pull the lever which drops down the discharge spout, and any quantity of material that is within the drum can be obtained.

The mixer is equipped with either steam or gasoline engine, the power being transmitted by a shaft and gearing. The larger mixers are provided with traction drive so that they may be moved to different parts of the job, thereby avoiding hauls. See Fig. 45. Figs. 46-47 show other views of the mixer. Fig. 48 shows a table giving different dimensions of various mixers.

Weight Without power	Output cubic yards per hour	Cost	
		With power	Without power
3350	7	\$600.00	\$500.00
4900	20	\$900.00	\$780.00
9100	30	\$1100.00	\$970.00

The Cream City Mixer.

The Cream City Mixer is manufactured by the Cream City Equipment Company at Milwaukee, Wisconsin. The machine is a drum mixer of the non-tilting type and is equipped with either steam

Special Street Paving
Mixer

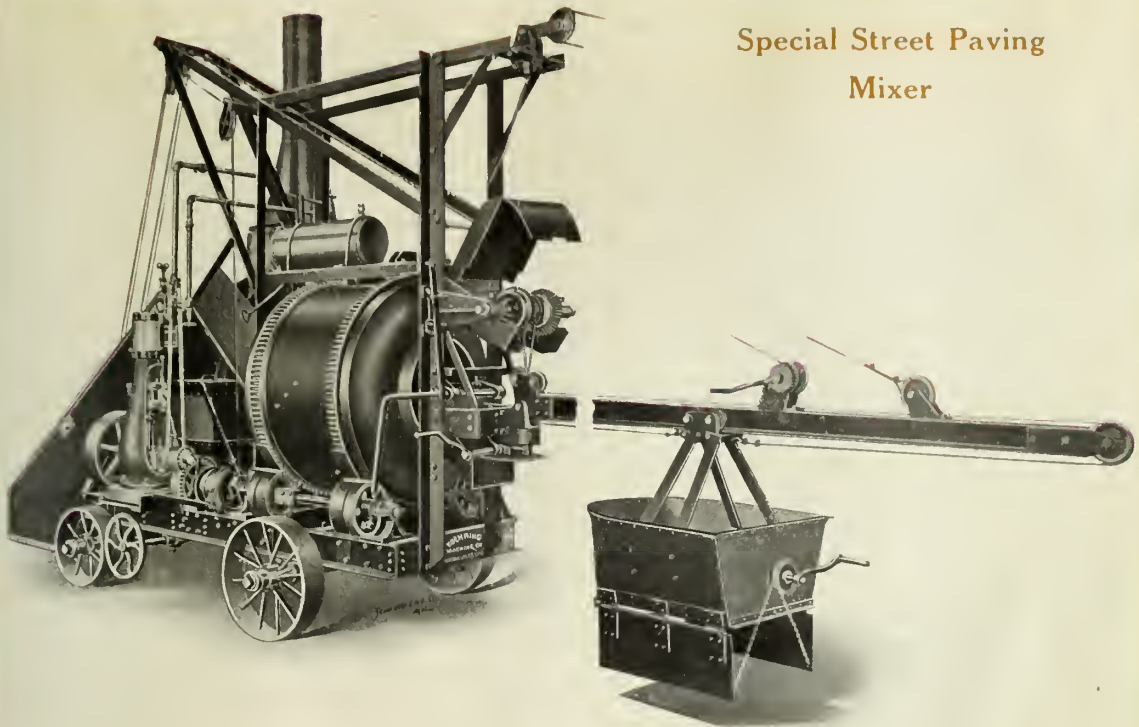

Equipped with Concrete Delivery Boom and Bucket.

Fig. 47.

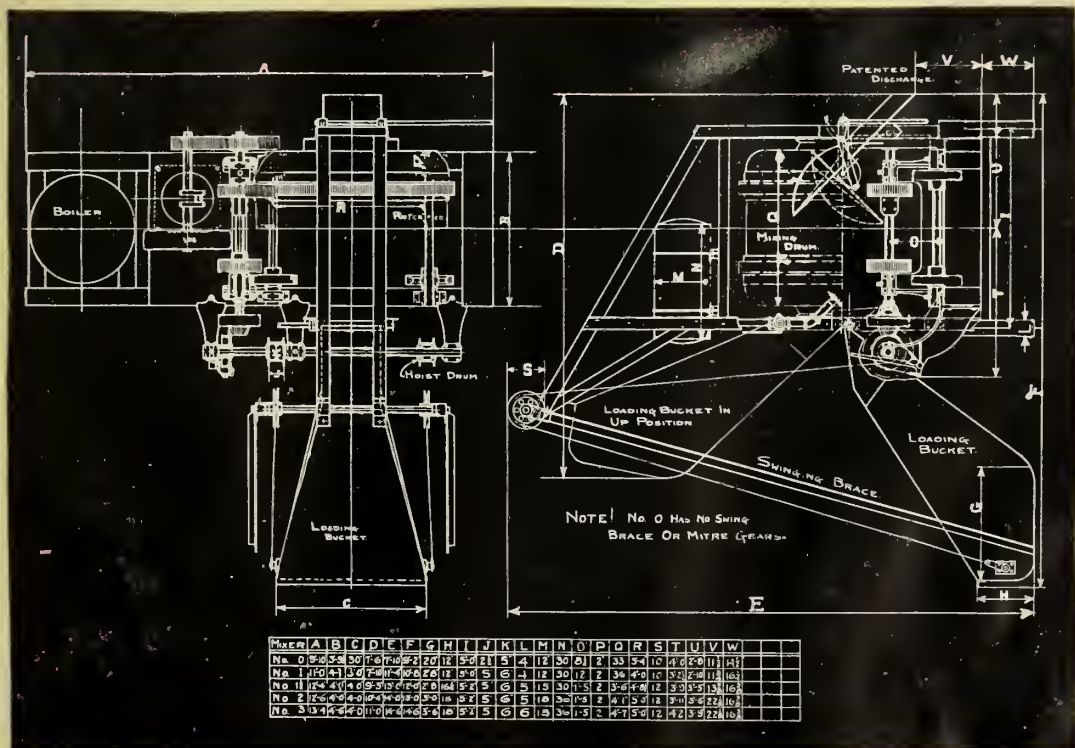

Fig. 48.

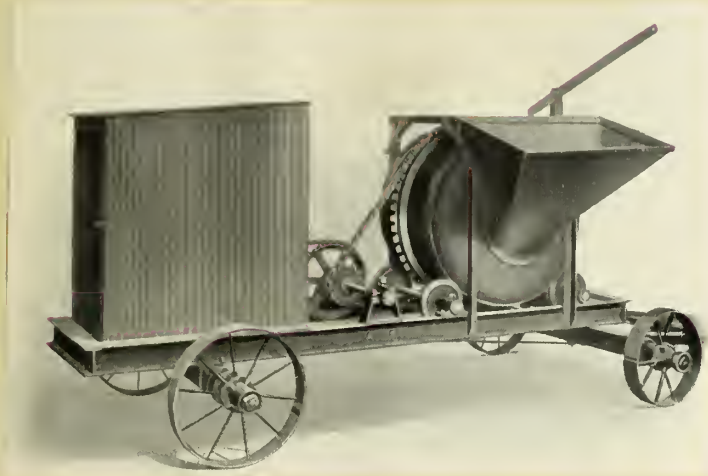

Fig. 49.

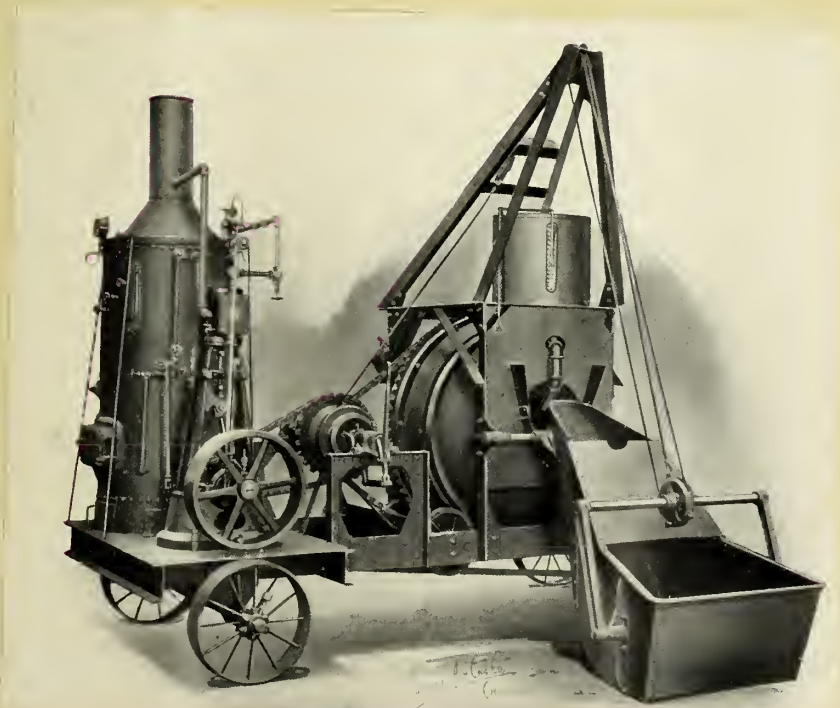

Fig. 50.

or gasoline engine.

The drum is driven by a center chain-belt drive which is said to be very efficient. The mixing is brought about by elevating buckets which are bolted to the inside of the drum. The machine can be used with either a batch hopper bin or a side loader, which consists of an automatic hoisting bucket. The makers claim that, when this is used, it is possible to turn out a batch every minute, provided the material is placed so that the mixer can be charged rapidly. It only requires fifteen seconds to mix a batch thoroughly and from ten to fifteen seconds to discharge it. For views of the mixer see Figs. 49-50.

Weight lbs. Without power	Output cubic yards per hour	Cost With power	Without power
1200	6	\$450.00	\$275.00
8000	60	\$1745.00	\$960.00

The Polygon Mixer.

The Polygon mixer is manufactured by the Waterloo Cement Machinery Corporation at Waterloo, Iowa. The mixer is of the tilting drum type.

The drum is polygonal or many sided in shape, being formed by two truncated cones mounted on the heads of a cylindrical drum. See Fig. 51. As the drum revolves, the action is such as to bring each surface of the aggregates into so many positions that each particle in the mass receives a uniform coating of cement. By means of blades (not shown in the figure) on the interior of the drum fastened with sufficient projection to avoid the secreting of the concrete, the mixing is accelerated. Also, the mixing is greatly aided by having the drum set at an angle of

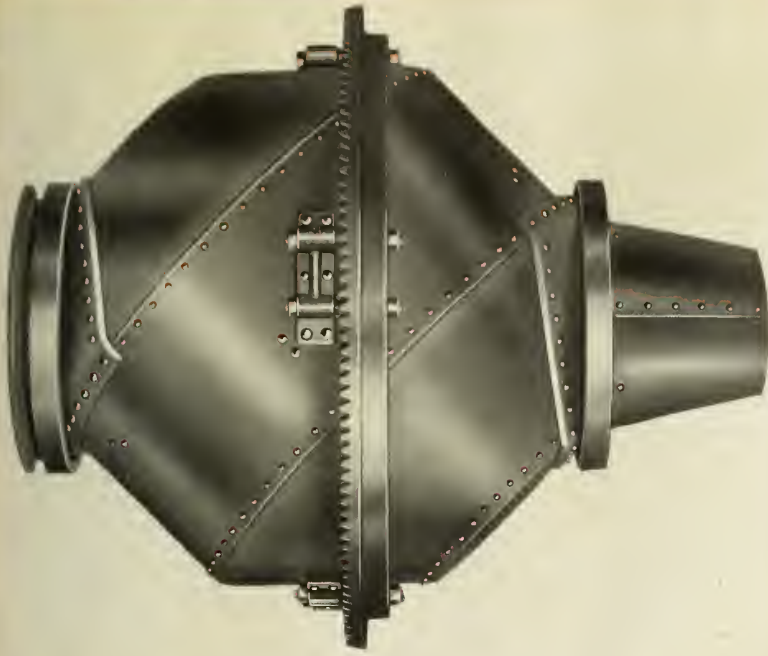

The Polygon Drum

Fig. 51.



Fig. 52.

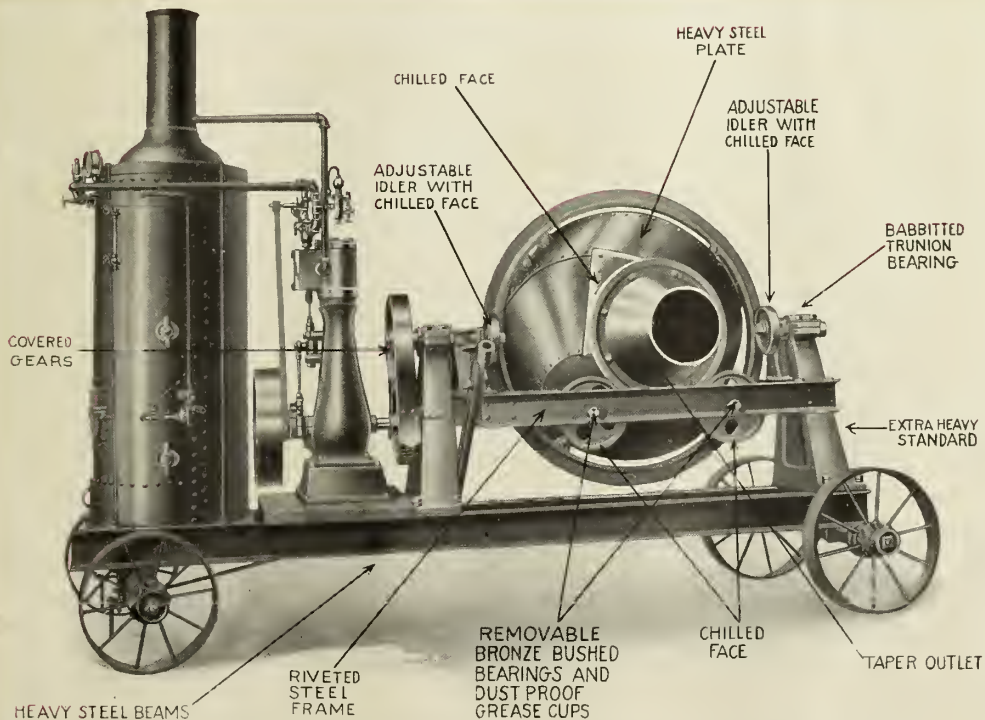

Specifications of Materials at a Glance

Material and Workmanship

Fig. 53.

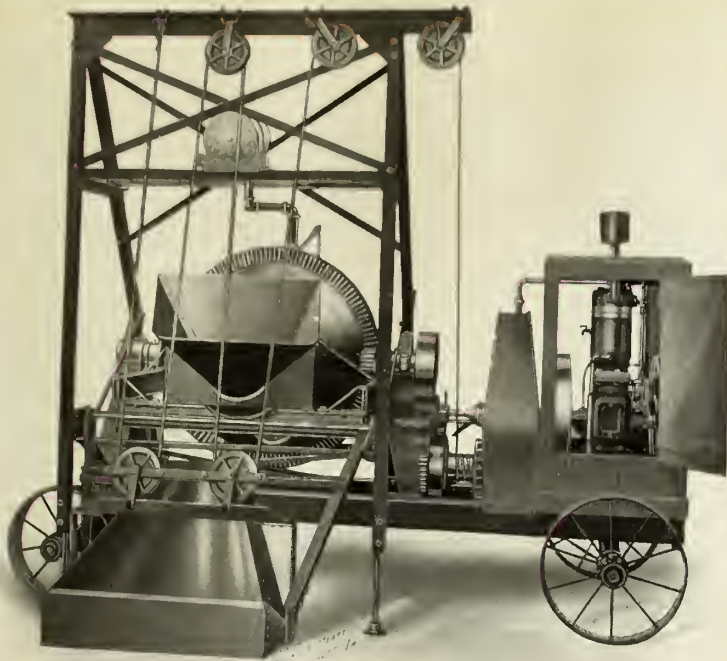

Polygon Power Loader

Fig. 54.

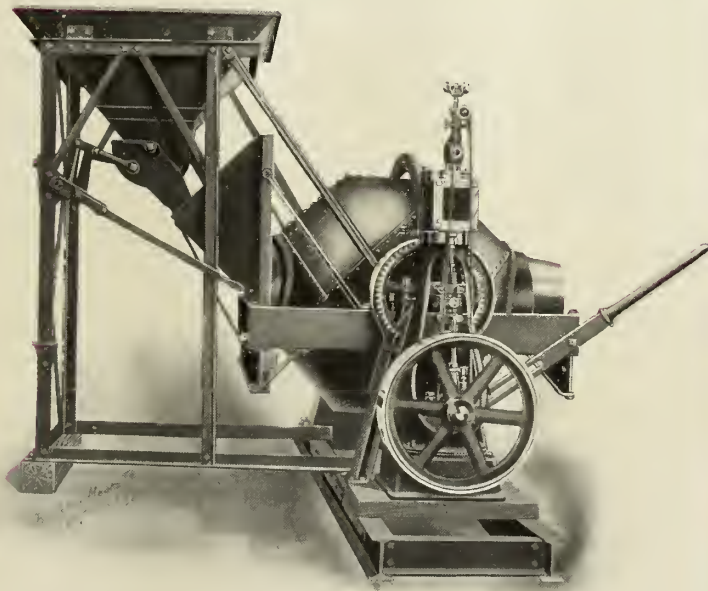

Polygon Mixer with Super Hopper

Fig. 55.

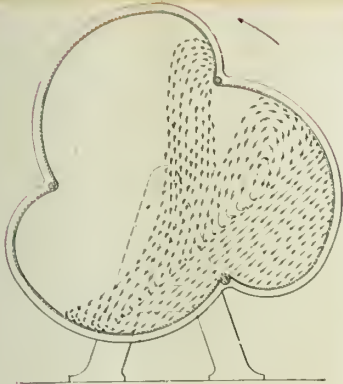

The "Involute Curved" Drum

Fig. 56.

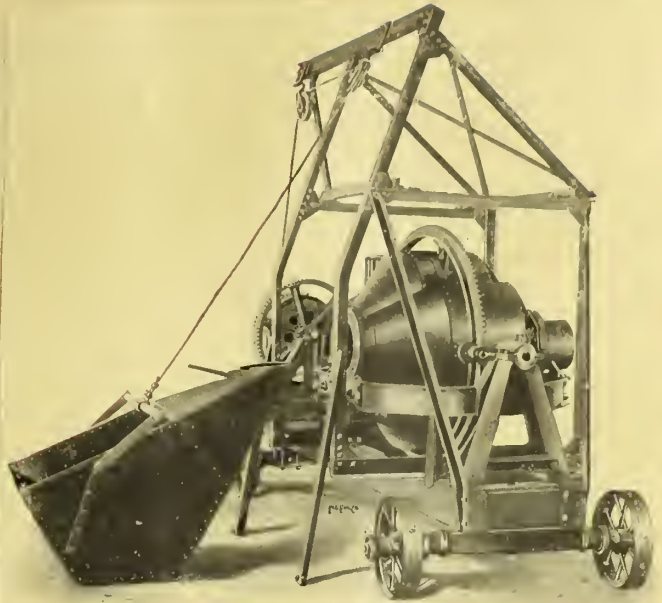

"Clover Leaf" Mixer with Power Side Loading Equipment

Fig. 57.

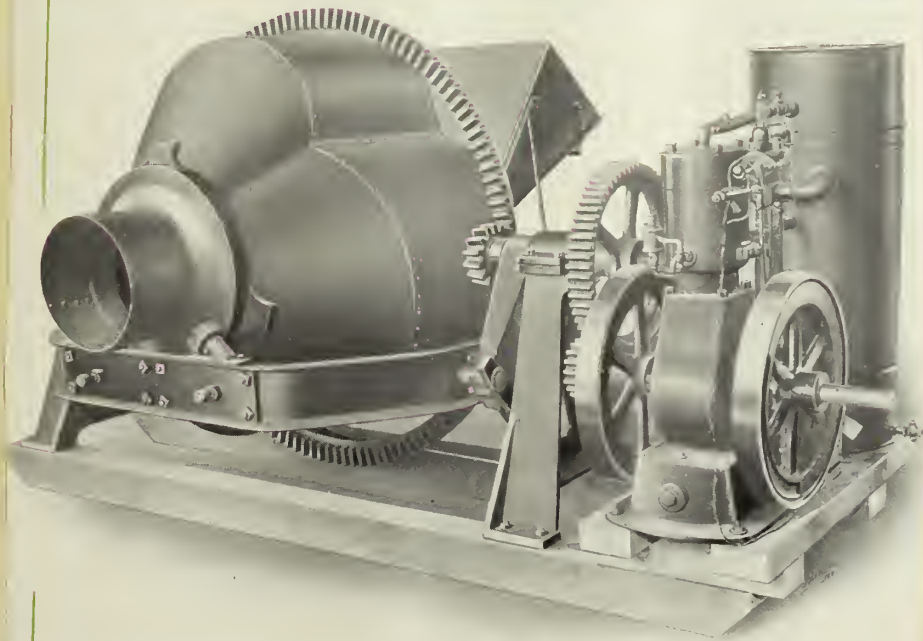

"Clover Leaf" Mixer with Gasoline Engine on Skids

Fig. 58.

45° to the main axis of the mixer. See Fig. 52.

Fig. 53 shows the general construction of the machine. The charging is done either by means of a batch hopper or a power loader. See Fig. 54. As was mentioned before, the discharge is accomplished by tilting the machine with a lever controlled by the operator. The machine is equipped with either gasoline, steam or electric power. The power is transmitted by a system of gears. Fig. 55 shows the mixer equipped with a device called a super-hopper. This is mounted on a steel frame and allows one batch to be assembled while another is being mixed.

Weight lbs Without power	Output cubic feet per batch	With power	Cost Without power
1450	4	\$640.00	\$570.00
3700	33	\$1425.00	\$1275.00

The Clover Leaf Mixer.

The Clover Leaf Mixer is manufactured by the Clover Leaf Machine Company at South Bend, Indiana. The mixer is of the drum type, and its peculiarity is the shape of the drum. See. Fig. 56.

In the figure the drum is revolving from right to left. As the material is carried along, it falls by its own weight when it reaches a certain point. It will be noticed that there are no deflectors or blades, and it is argued that the shape of the drum fully replaces these. The figure shows that there is a double action of the material in the drum. A part of the mass falls, and is doubled over from the upper involute curve, while the balance falls and is doubled over from the section of the curve just below. By this motion all of the material is effect-

ively and absolutely mixed three times at each revolution.

The charging may be done by means of a hopper, or may be done with the side loading equipment as shown in Fig. 57. In discharging, the drum is tilted by a lever under the control of the operator who can discharge any portion of the batch that is desired. The drum may be tilted while in motion.

Either steam or gasoline may be used to operate the machine. The power is transmitted by gears. See Fig. 58.

Weight lbs. Without power	Output cubic yards per day	Cost With power	Cost Without power
1600	30	\$475.00	\$385.00
3100	130	\$850.00	\$760.00

The Ransome Mixer.

The Ransome Mixer is manufactured by the Ransome Machinery Company at Dunellen, N.J. The machine is of the non-tilting drum type.

The interior of the drum is shown in Fig. 59. The mixing principle is a combination of rolling contact and forcible kneading. The first is accomplished by the revolution of the drum; the second, by the action upon the materials of the blades or scoops attached to the inside of the drum. As the drum revolves, the material coming within the scope of one of these blades is subjected to a pressure from the sides of the trough formed by the converging blade and cylinder head. Cross action is secured by the arrangement of the angles formed by the scoops with the heads of the drum. (Not shown in the figure.)

The machine is charged either by a batch hopper or a pivot-charging hopper. See Figs. 60-61. By noticing Fig. 61 it

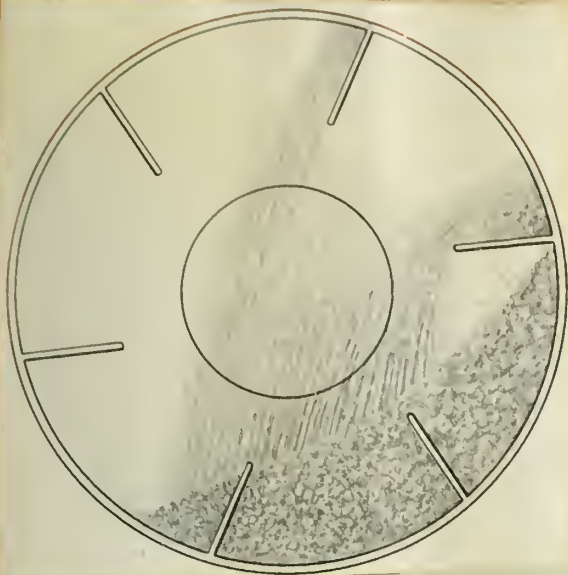

Fig. 59.

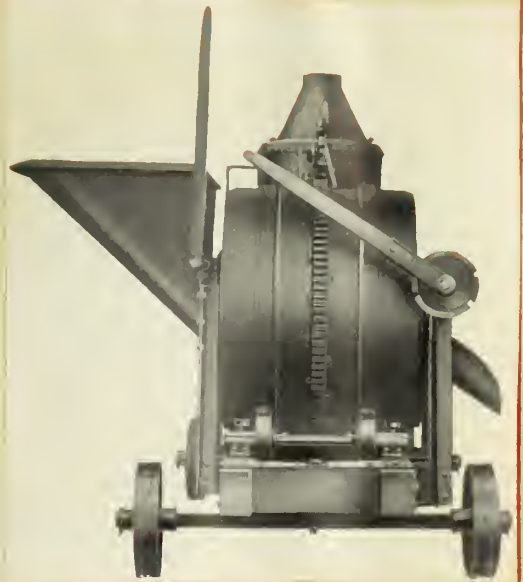

Fig. 60.

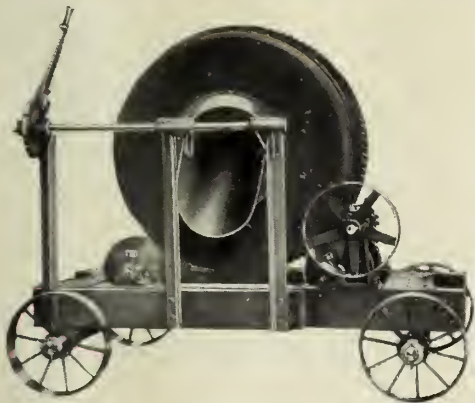

Fig. 63.

Figure 1031

POSITION OF DISCHARGE CHUTE WHEN DISCHARGING



Fig. 61.

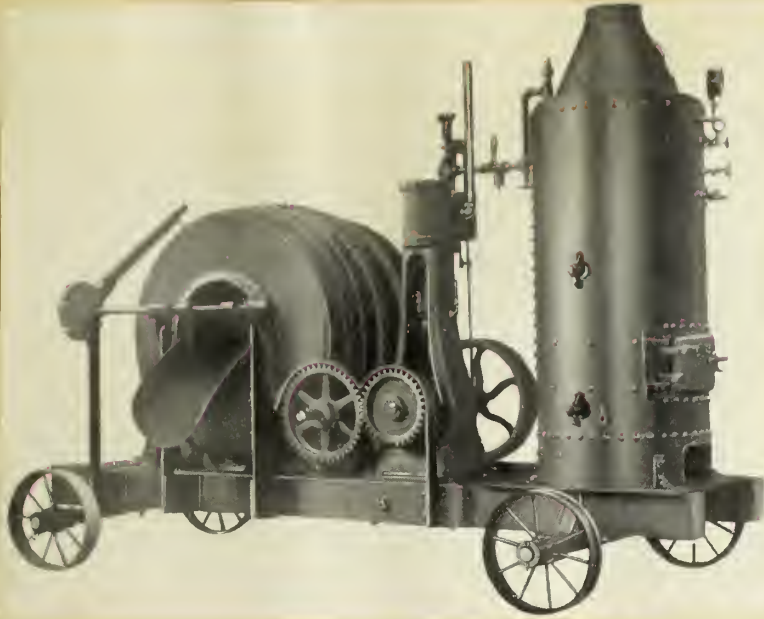

Fig. 64.

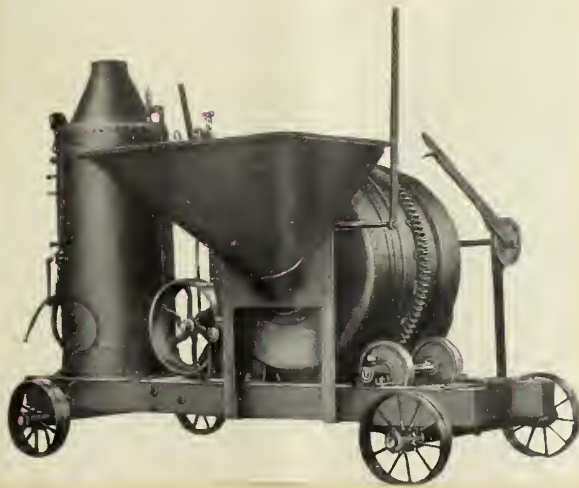
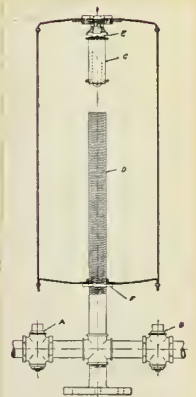

Fig. 65.



RANSOME WATER
TANK

Fig. 66.

will be seen that the hopper is hoisted by a friction drum mounted on the side of the mixer frame and driven by an extension of the mixer countershaft. The discharge is accomplished through a chute without tilting the drum. By opening a gate controlled by a lever, any part of the batch may be discharged. See Fig. 63.

The machine is driven either by a steam or gasoline engine, the power being transmitted by gears. Figs. 64-65 show the general construction of the machine.

Fig. 66 shows an automatic measuring device for delivering water to each batch of concrete. The water from the supply pipe enters at A, and passes up through the threaded pipe D into the tank. The float C closes a valve E, when the tank is full of water. Upon opening the valve B and closing A the water flows into the concrete mixer until it reaches the level of the top of the threaded pipe D, when it ceases flowing. By screwing the tank up or down on pipe D, any desired quantity of water can be turned into the drum for each batch of concrete.

Weight lbs. Without power	Capacity cubic yards per hour	Cost With power	Cost Without power
1500	7	\$430.00	- -
13000	80	\$1951.00	\$1250.00

The Marsh-Capron Mixer.

The Marsh Capron Mixer is manufactured by the Marsh-Capron Company at Chicago, Ill. The mixer can be purchased as either tilting or non-tilting.

Fig. 67 shows the interior of the drum. The mixing blades and buckets are so placed as to give a thorough mixing action to the material, creating an end to end as well as a

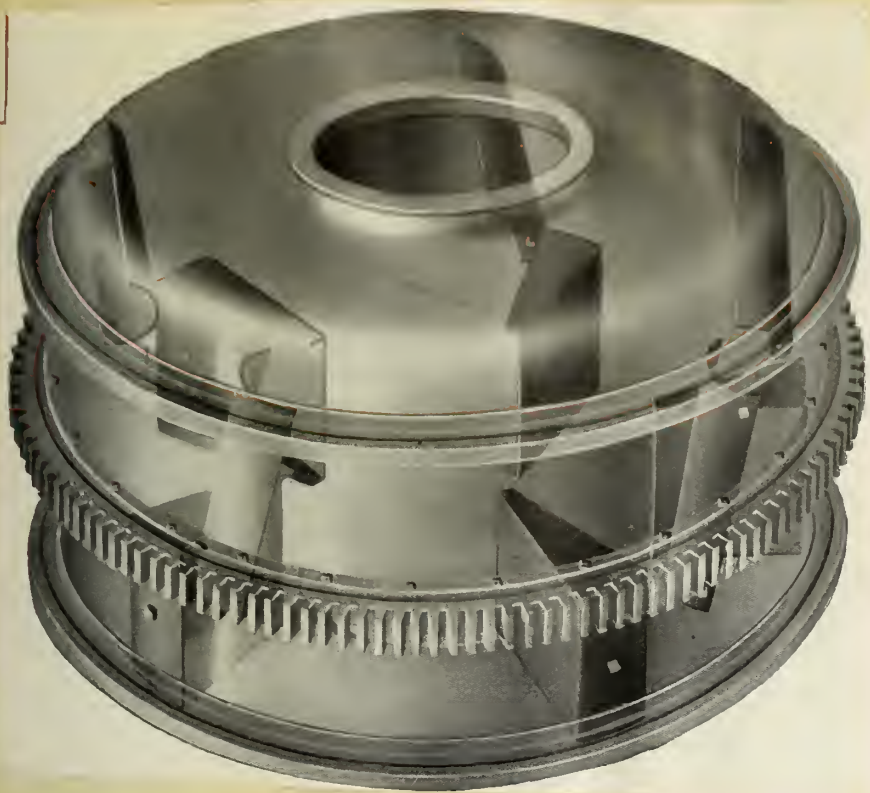

Fig. 67

Fig. 68



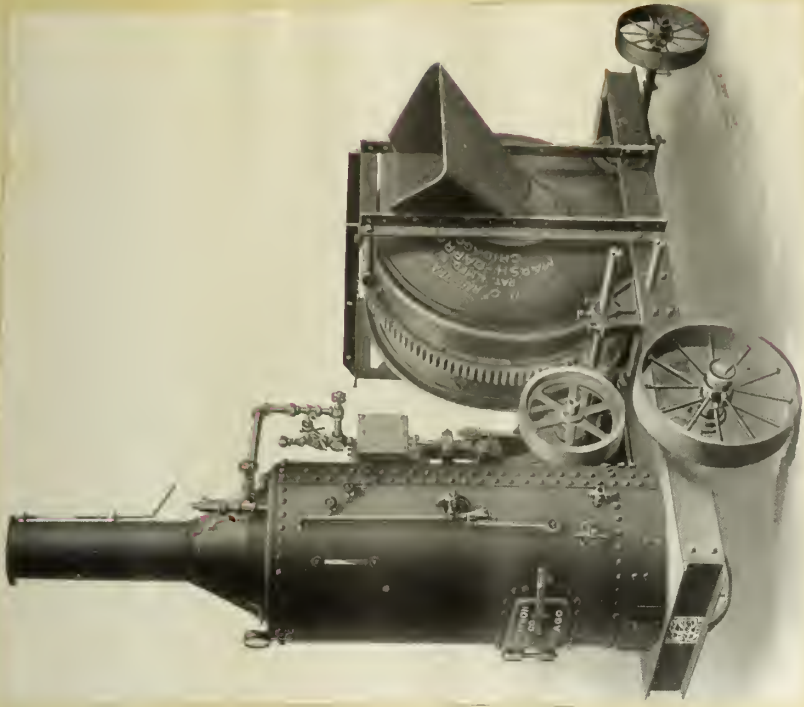

Fig. 70.

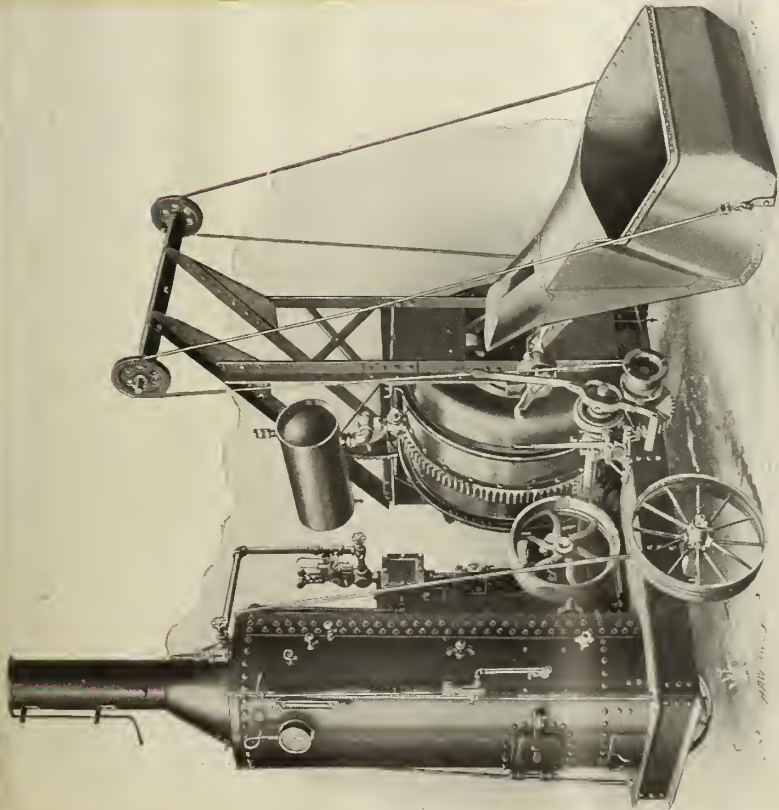

Fig. 71.

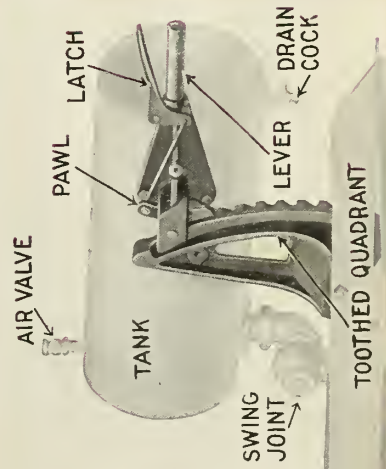

Fig. 69.

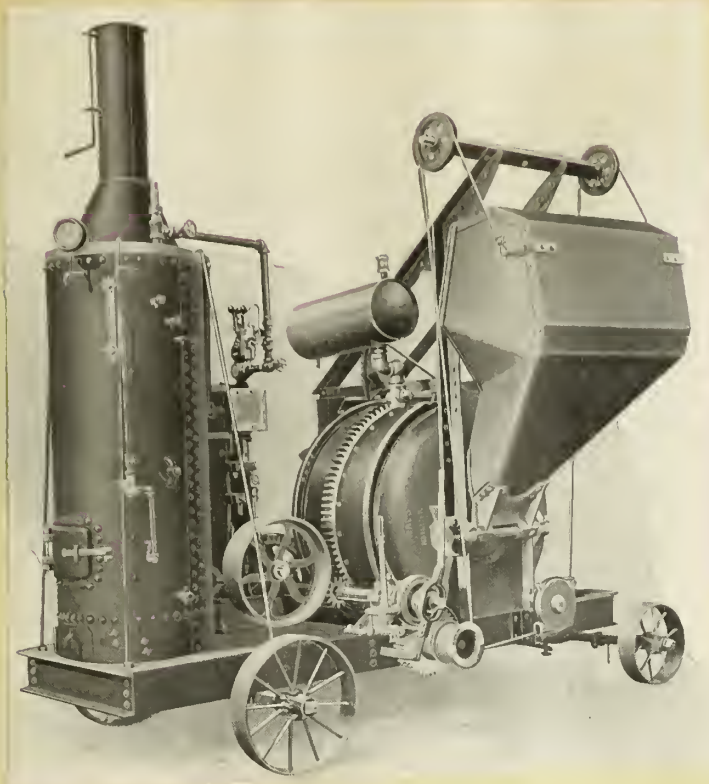

Fig. 72.

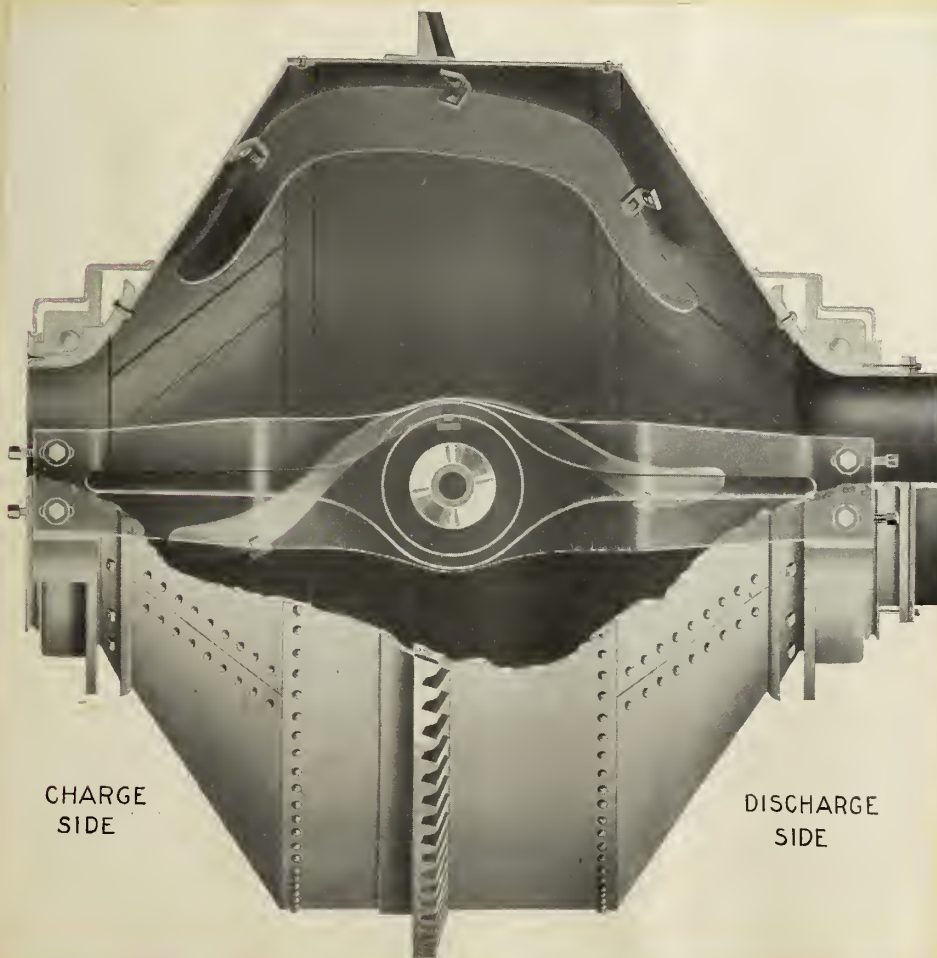

Fig. 73.

CHARGE
SIDE

DISCHARGE
SIDE



Fig. 75.

Fig. 78.

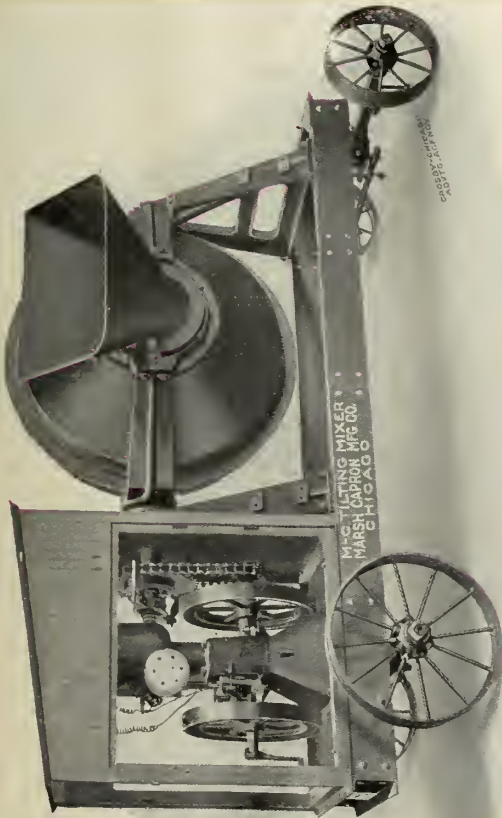
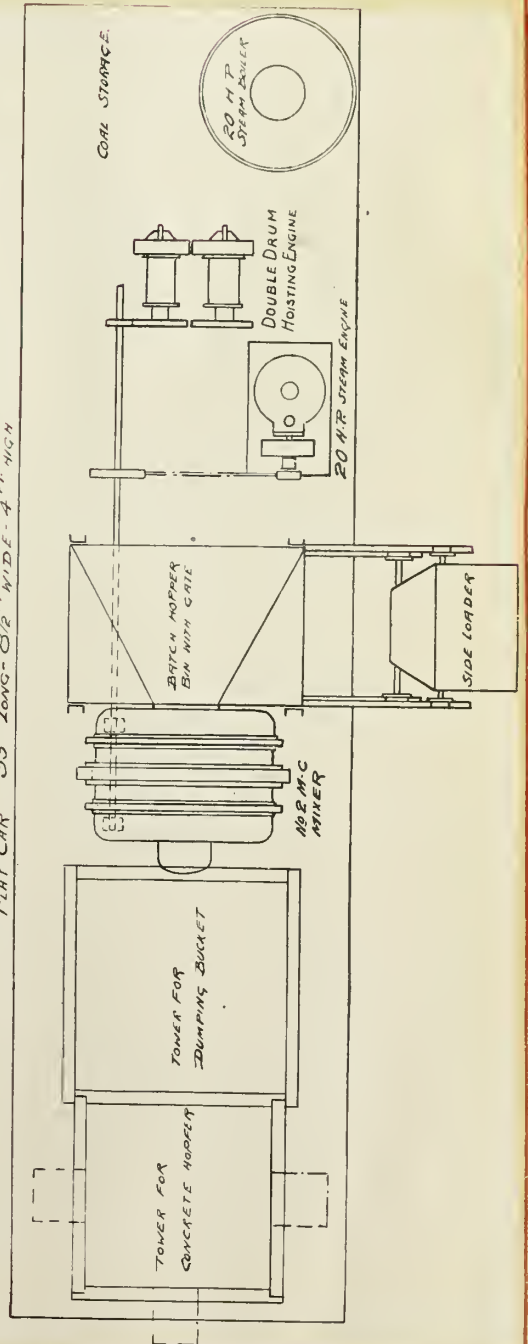

Fig. 74.

FLAT CAR 33 FT LONG - 8 1/2 FT WIDE - 4 FT HIGH



lifting and pouring action. Fig. 68 shows another view of the deflectors and carriers, and the angles of adjustment. The drum is driven by a single gear center drive.

Fig. 69 shows an automatic water tank. It will be seen from the figure that if more water is wanted, the rear of the tank is raised; if less water is wanted, the tank is lowered. When it is desired to discharge the water from the tank into the drum, the lever on the three-way cock is given a quarter turn, shutting off the supply and opening the discharge pipe into the drum, allowing the water to flow from the tank. When the flow ceases, the lever on the cock is turned to its first position, opening the supply pipe to the tank and closing the pipe to the drum, allowing the tank to fill.

Fig. 70 shows a view of the non-tilting mixer and its charging side. Figs. 71-72 show views of the mixer with a power loading hopper. The power loading hopper is fastened to the charging side by a pivot shaft turning in heavy bearings.

Fig. 73 shows a sectional view of the drum of the tilting mixer. The blades are arranged in a serpentine form and are attached to the drum with brackets. This leaves ample space between the blade and the drum, making it easily kept clean and free from pockets or corners.

Fig. 74 shows a view of the charging side of the mixer. Fig. 75 shows the mixer in a discharging position. The machine may be driven by either electric motor, or steam or gasoline engine. Fig. 76 shows a view of a street paving mixer equipped with a loading skip and traction power.

Figs. 77-78 show views of a Marsh-Capron plant mounted

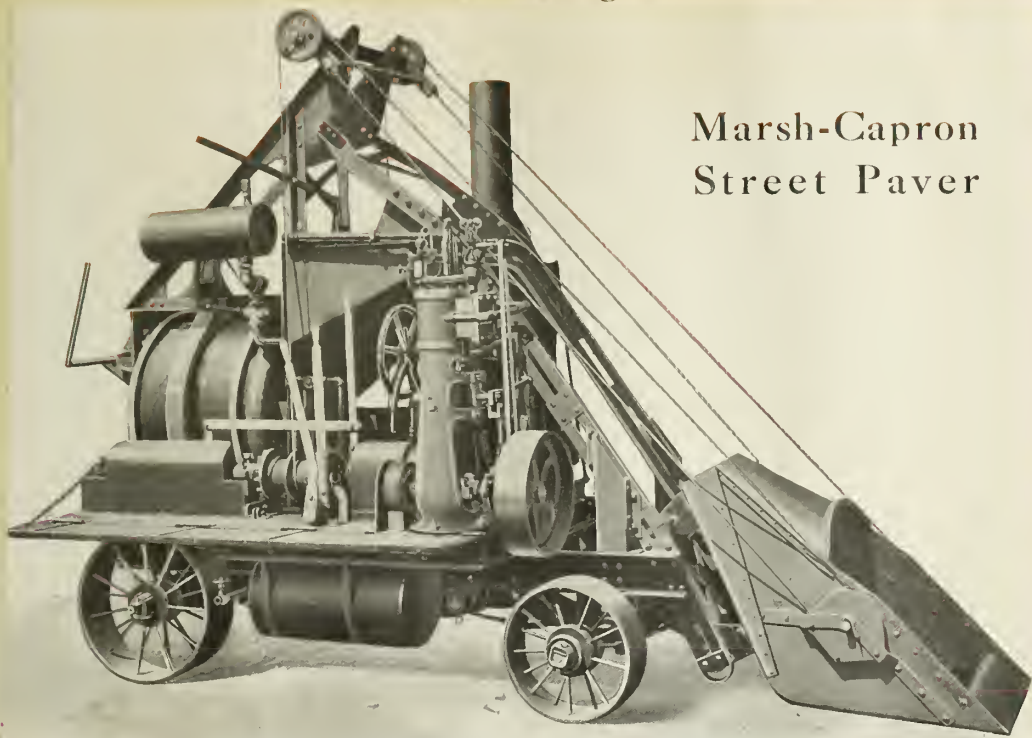

Marsh-Capron
Street Paver

Fig. 76.

SPECIAL M-C PLANT MOUNTED
ON FLAT CAR WITH TARC-
TION GEARING

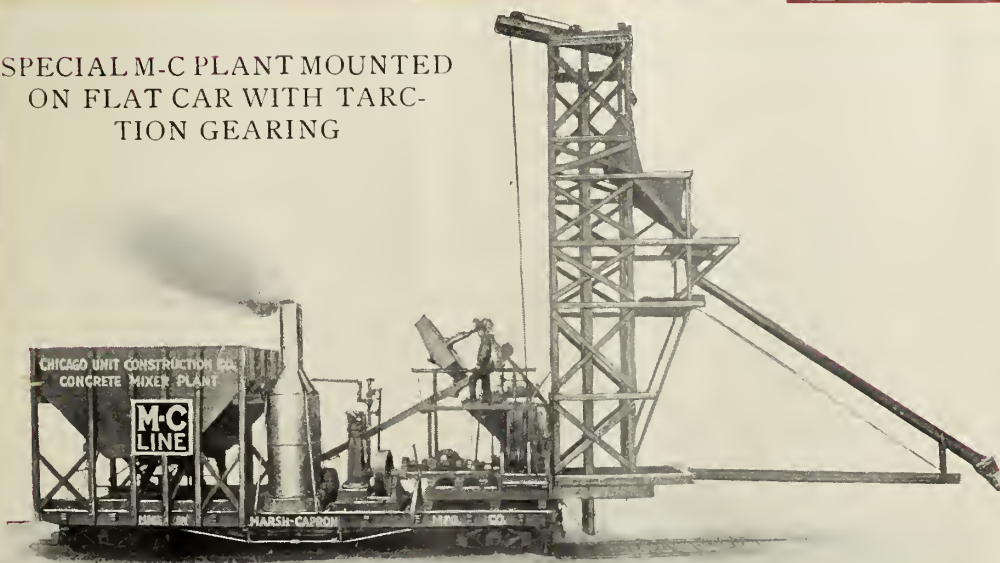

Fig. 77.

on a flat car with traction gearing. The car used is a standard rail road flat-car, which moves along the track under its own power. The mixer is equipped with a batch hopper and automatic water measuring tank. The engine is geared directly to a line shaft from which the power is transmitted to the hoisting drums for operating the concrete bucket in the tower and the loading skip for the mixer. The storage bins have a capacity of ten yards of sand and twenty yards of stone. They deliver directly into the charging skip which runs on a spiral track and dumps into the batch hopper of the mixer. As illustrated, the skip is in dumping position. The mixed concrete is hoisted on an elevator, and discharged and put in place by the long trough shown at the right.

Non-Tilt. Mixers.

Weight Without power	Output cubic yards per hour	With power	Cost Without power
2420	7	\$600.00	\$475.00
5940	35	\$1120.00	\$950.00

Tilting Mixers.

1650	5	\$600.00	\$475.00
4400	30	\$1060.00	\$900.00

The Foote Batch Mixer.

The Foote Batch Mixer is manufactured by the Foote Manufacturing Company at Nunda, N.Y. The mixer is of the non-tilting type. Fig. 79 shows a view of the mixer. The essential characteristics are the low mounting of the mixer drum, which permits lower charging hoppers; and the double drive gears and large drum rolls.

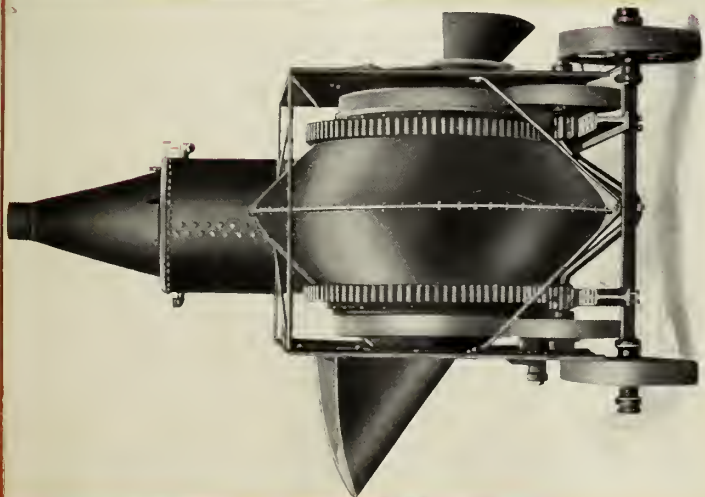

Fig. 79.

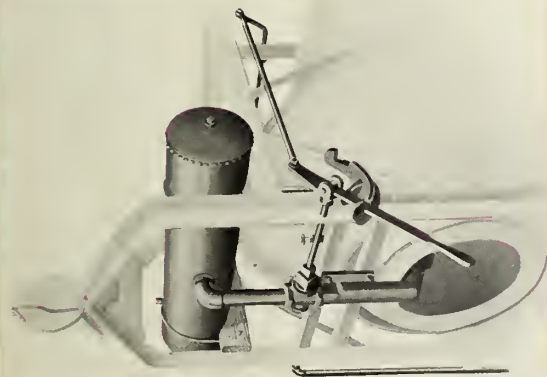

Fig. 82.

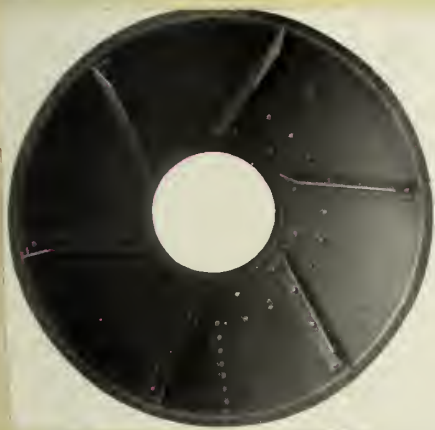

Figure 19
Charging Wings

Fig. 80.



Figure 20
Discharge Scoops

Fig. 81.

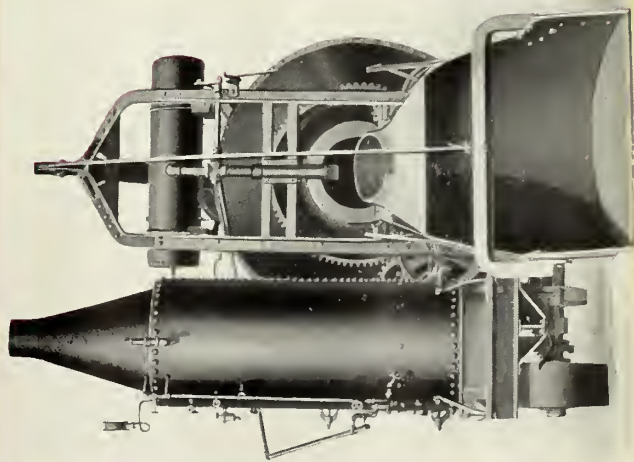

Fig. 83.

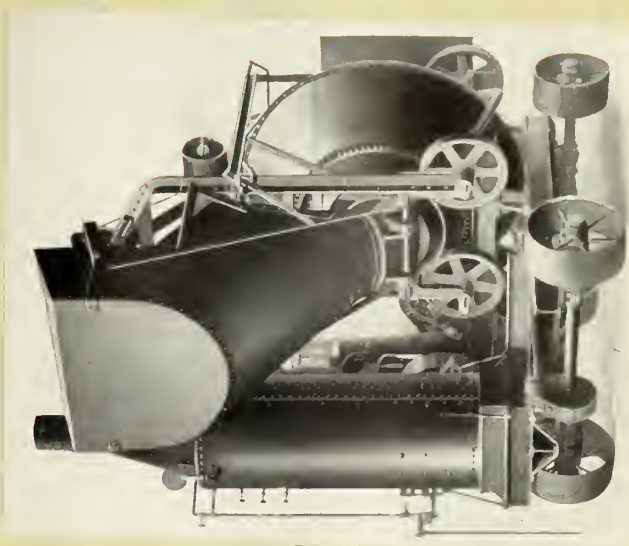

Fig. 84.

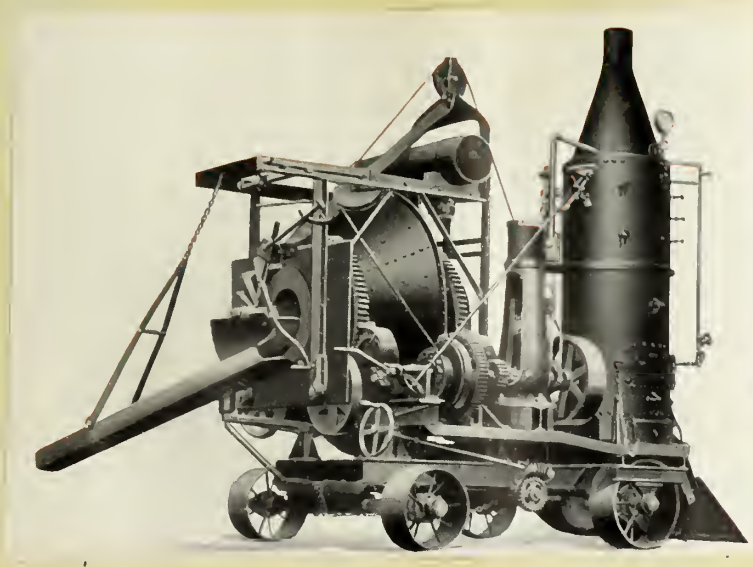

Fig. 85.

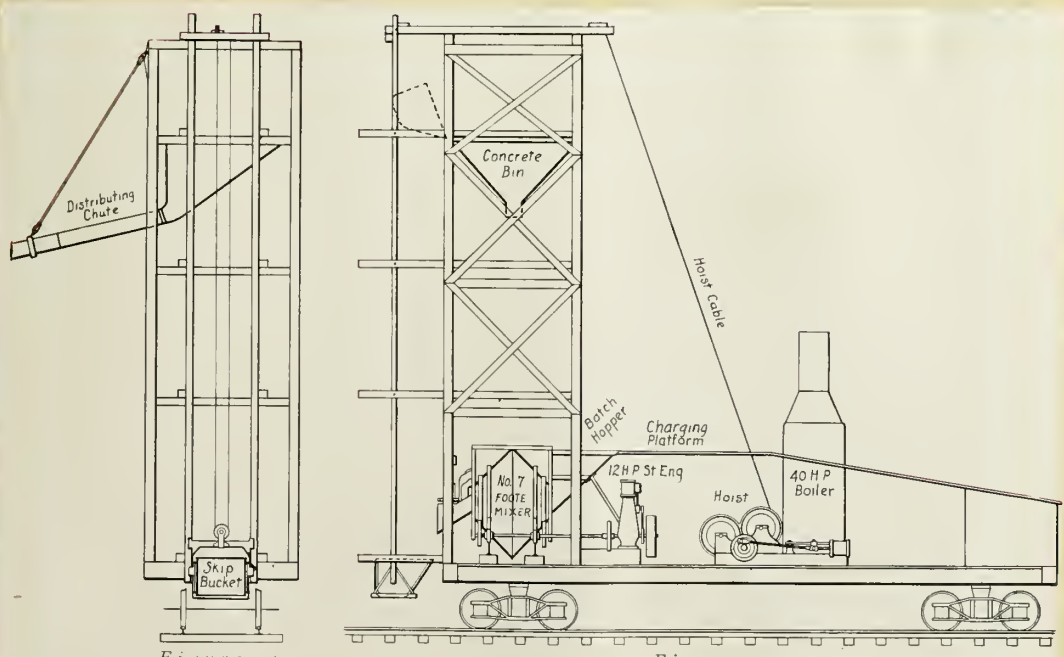

Figure 41
End Elevation

Figure 42
Side Elevation

Footo Railway Car Mixing and Distributing Plant

Fig. 86.

Fig. 80 shows the interior of the drum on the charging side. The six wings shown in the figure pick up and propel the material towards the center of the drum, accelerating both the charging and the mixing action. They also set up a cross action of the materials which is necessary to insure thorough incorporation. Fig. 81 shows a view of the interior of the drum on the discharge side. Twelve broad discharge wings or scoops carry the materials constantly to the top of the drum and empty them into the discharge chute, when ready for delivery.

Fig. 82 shows the automatic measuring tank which furnishes water at a pressure of 200 lbs. per sq. in. The handle shown in the figure serves both to fill and empty the tank. This may be attached to either side of the machine, making it possible to operate the tank from either the charging side or discharge side.

Fig. 83 shows the mixer with loading skip ready for charging. Fig. 84 shows the same mixer with loading skip in a position with the skip at an angle of 50° . It is claimed that the loading skip will discharge a batch into the drum in ten seconds. Fig. 85 shows a view of the gravity distributor which will deliver the mixed concrete in a working radius of up to 15 feet. It can be attached either to end discharge or side discharge machines. It will be seen from all figures that the power is transmitted through gears. Machines are equipped either with gasoline, electric, or steam power.

Fig. 86 shows a sketch of a railway-car mixing plant. The mixer is mounted on an ordinary flat-car, and the mixed concrete is hoisted by a cable, and placed with a discharge chute

by means of gravity.

Weight lbs. Without power	Output cubic yards per hour	Cost	
		With power	Without power
3000	10	\$875.00	\$725.00
7900	40	\$1300.00	\$1150.00

The Chicago Concrete Mixer.

The Chicago Mixer is manufactured by the Chicago Concrete Manufacturing Company at Chicago, Ill. The mixer is of the non-tilting drum type.

Fig. 87 shows the interior view of the drum. The drum is a cylinder with four deflecting surfaces or inclined planes. The lifting blades are arranged in pairs and raise the materials, which drop upon inclined planes at the discharge end. Since these surfaces are angular, the falling materials are thrown across the drum and returned again by the opposing deflectors. Thus, the mass is constantly cut into, poured, turned over, thrust sidewise, folded, and laterally returned and refolded. The makers claim that the mass is subjected to twelve distinct mixing actions per turn of the drum.

Fig. 88 shows a view of the discharge side. A swinging spout, pivoted below the discharge opening, is projected into the drum, and the mixed mass falls from the blades upon it. Since this chute stands at a steep angle, a rapid flow of concrete takes place.

Fig. 89 shows a view of the water tank. When properly set by the graduated scale, uniform and exact quantities of water can be introduced into each batch. The capacity of the



Chicago Mixer Drum.

Fig. 87.

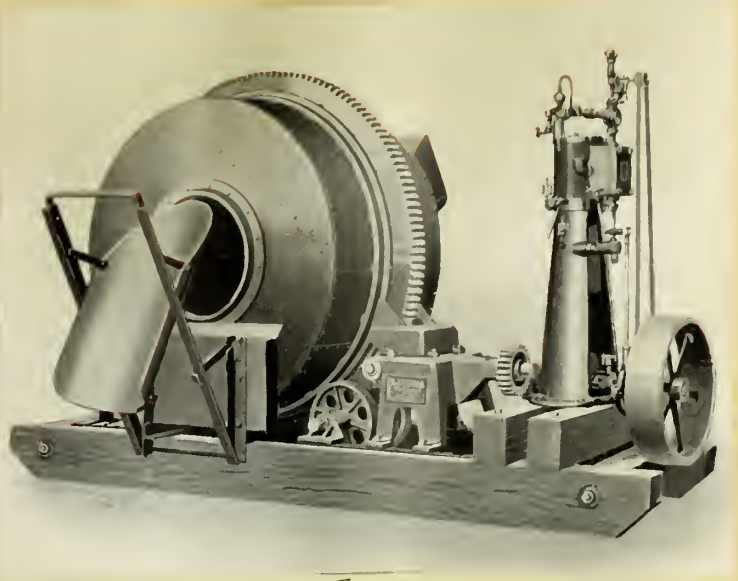

Fig. 88.



Automatic Water Tank.

Fig. 89.

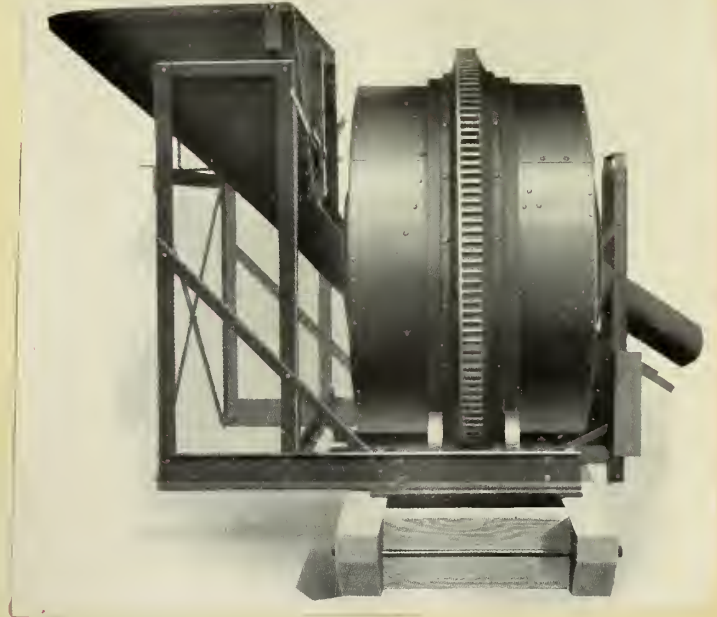

Fig. 90.

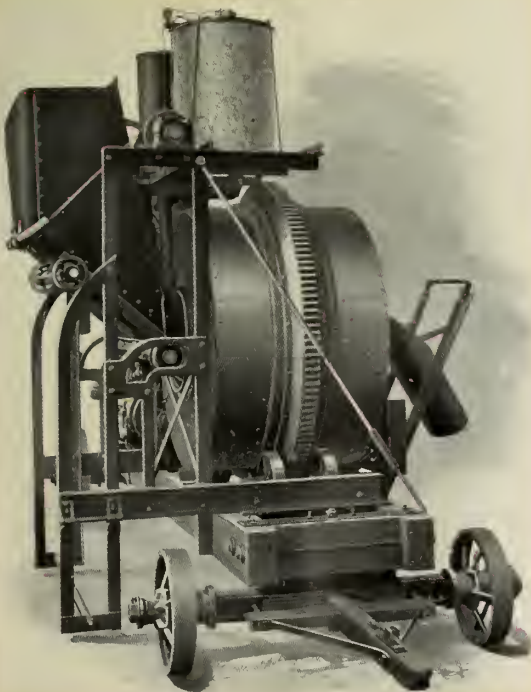

Fig. 91.



Chicago Side-Feed Railway Paving Mixer.

Fig. 92.



Chicago Street Paving Mixer with distributing cylinder.

Fig. 93.

tank is eighteen gallons. Fig. 90 shows a mixer with a batch carrying hopper. This hopper is used in connection with an elevated runway. The ingredients are dumped directly from the wheelbarrow into the hopper. Fig. 91 shows a view of the mixer with charging skip in raised position; a switch causes the skip to tilt as it progresses upward on the curved guides.

Fig. 92 shows a view of side feed railway paving mixer. Two charging skips are furnished, one on each side of the mixer, so that the wheelers may work on either side of the car. Two chutes are furnished: the standard discharge spout, and a special spout which distributes the concrete over the entire width of the road bed.

Fig. 93 shows a view of a street paver mixer. The machine has batch mixing action with a continuous discharge. A distributing cylinder, consisting of a steel pipe fifteen feet long, revolves by means of sprockets and chains. Blades, riveted inside of the cylinder, keep the concrete constantly in motion towards the end of the distributor. The cylinder swings in a radius of 180°. The concrete can thus be placed exactly where required at any point in a thirty-foot street, dispensing with cars, carts, and wheelbarrows.

In all machines the power is transmitted by gears, and power may be either electric, gasoline, or steam.

Weight lbs. Without power	Output cubic yards per hour	Cost	
		With power	Without power
1300	5	\$430.00	\$325.00
4500	32	\$1000.00	\$790.00

The Chain Belt Concrete Mixer.

The Chain Belt Concrete Mixer is manufactured by the Chain Belt Company at Milwaukee, Wis. The mixer is one of the non-tilting drum type. Fig. 94 shows the exterior of the drum. The essential characteristic is that the drum is driven by a chain instead of a belt. The sprocket teeth are cast in sections which are bolted to the drum. They are amply strong to withstand any strain that they may receive in operation, but, if through accident one should be broken, it can be replaced in a few minutes at a small expense. Fig. 95 shows the interior of the drum. The bulge on the discharge side increases the capacity of the drum. The mixing blades are made of 1/4 inch steel, riveted to cast-steel brackets which are bolted to the drum. The blades are raised to allow a free passage of water under them. The elevating buckets, shown in the figure, facilitate in raising the material. Fig. 96 shows a view of the power transmission. It is claimed that the chain produces less friction than the gear drive. The charging is done by means of a hopper or power loader. See Fig. 97. Fig. 98 and Fig. 99 show views of the power loader in different positions. The loader is filled while the previous batch is being mixed in the drums. As soon as one batch has been mixed and discharged, the loader is elevated, and another full batch emptied into the drum. Fig. 100 shows a view of the automatic measuring tank. By opening the valve in the outlet pipe and allowing the tank to empty, the proper amount of water always enters into each mix. Any part of the contents of the tank may be discharged by watching the gauge pointer and



Malleable Lifting Buckets

1/4" Steel Mixing Blades

Cast Steel Brackets

Walls 1/4" thick

Mixing Drum Interior

Fig. 95.

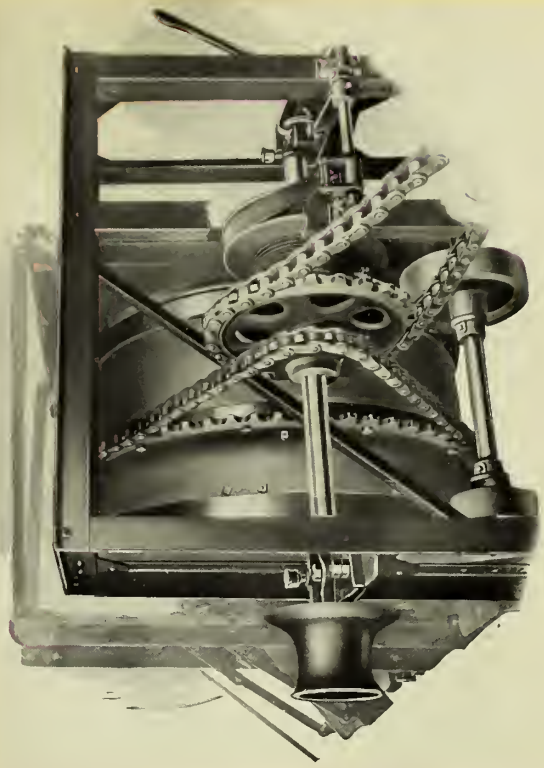

Countershaft with Sprocket Wheels, Hoisting Drum and Clutch for Power Loader

Fig. 96.



This sprocket is put on in sections.

Mixing Drum Exterior

Fig. 94.

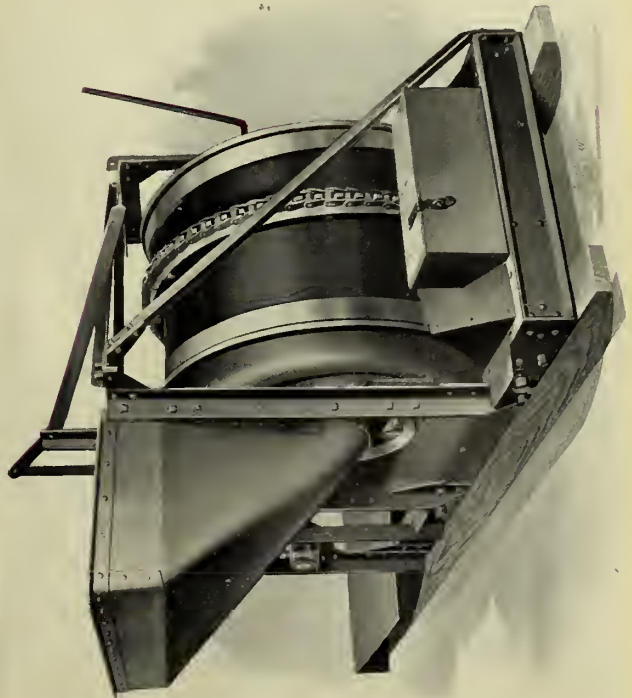

Fig. 97.

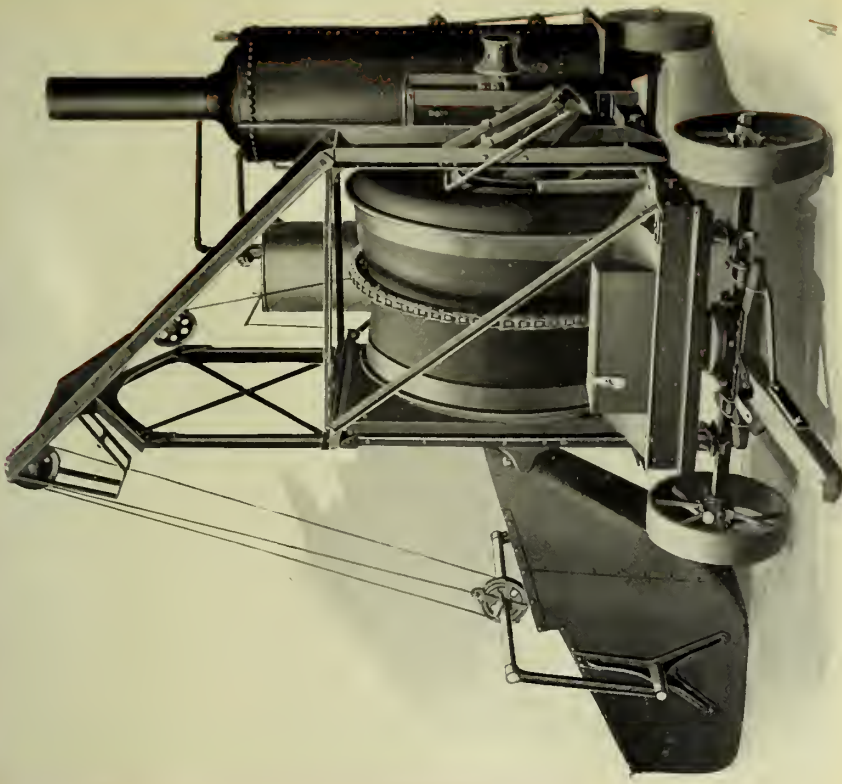

Fig. 98.



Power Loader

Fig. 97.

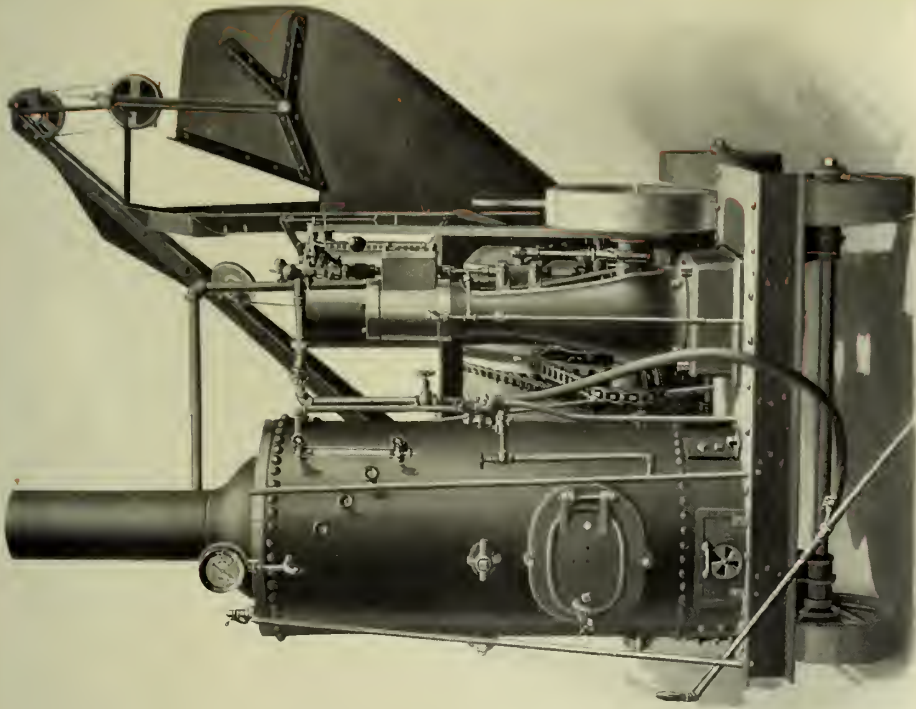
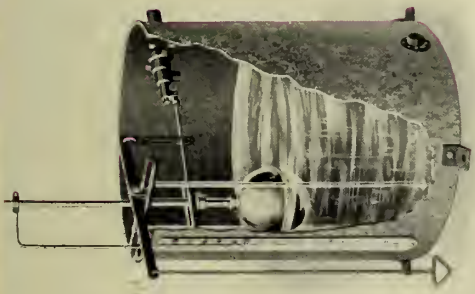

Fig. 99.



Sectional
View
of
Water Tank

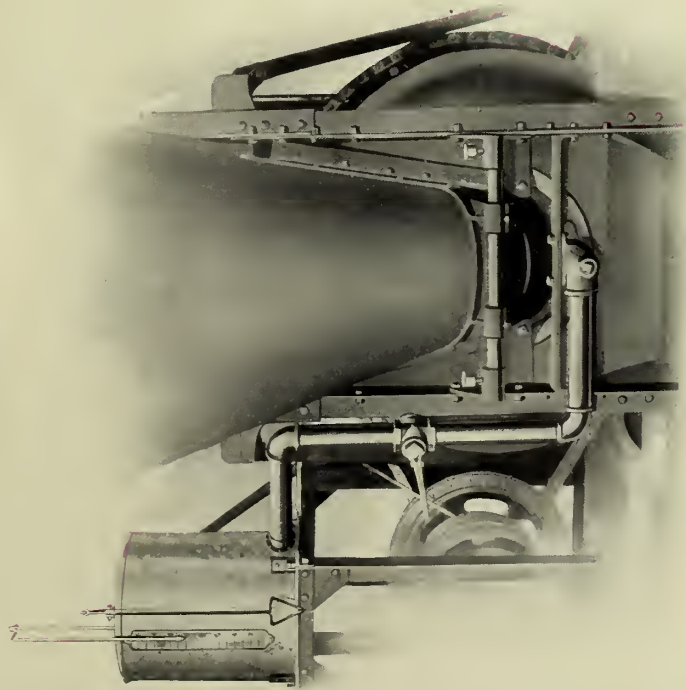

Fig. 100.

closing the valve at the proper time.

Weight lbs. Without power	Output cubic yards per hour	Cost	
		With power	Without power
2700	8	\$760.00	\$650.00
10400	40	\$1150.00	\$925.00

The Chicago Improved Cube Mixer.

The Cube Mixer is manufactured by the Municipal Engineering and Contracting Company, at Chicago, Ill. The mixer is of the tilting drum type. The essential characteristic is that the drum is shaped like a cube, as the name implies. Fig. 101 shows the movement of the concrete in the direction of the plane of rotation of the cube. The batch is folded over on itself, and pressed into a contracting space shaped alternately like a wedge and like a pyramid. It is claimed that the whole batch is folded and pressed into the shape of a wedge six times and folded and pressed into the shape of a pyramid six times for each revolution of the cube. The following statement is made by the makers, "that in other mixers the first cubic foot never comes in contact with the third cubic foot to say nothing of the twenty-seventh cubic foot, while in the cube mixer, a cubic yard batch is mixed as a unit, and every part comes in contact under pressure with every other part many times". The mixer may be charged by means of a batch hopper or power loader. Fig. 102 shows the mixer in a discharging position, and shows the loader charging the drum. It is seen that the elevator consists of a double track or guides set at an angle and firmly attached to the mixer frame and requiring no other support. The bucket is

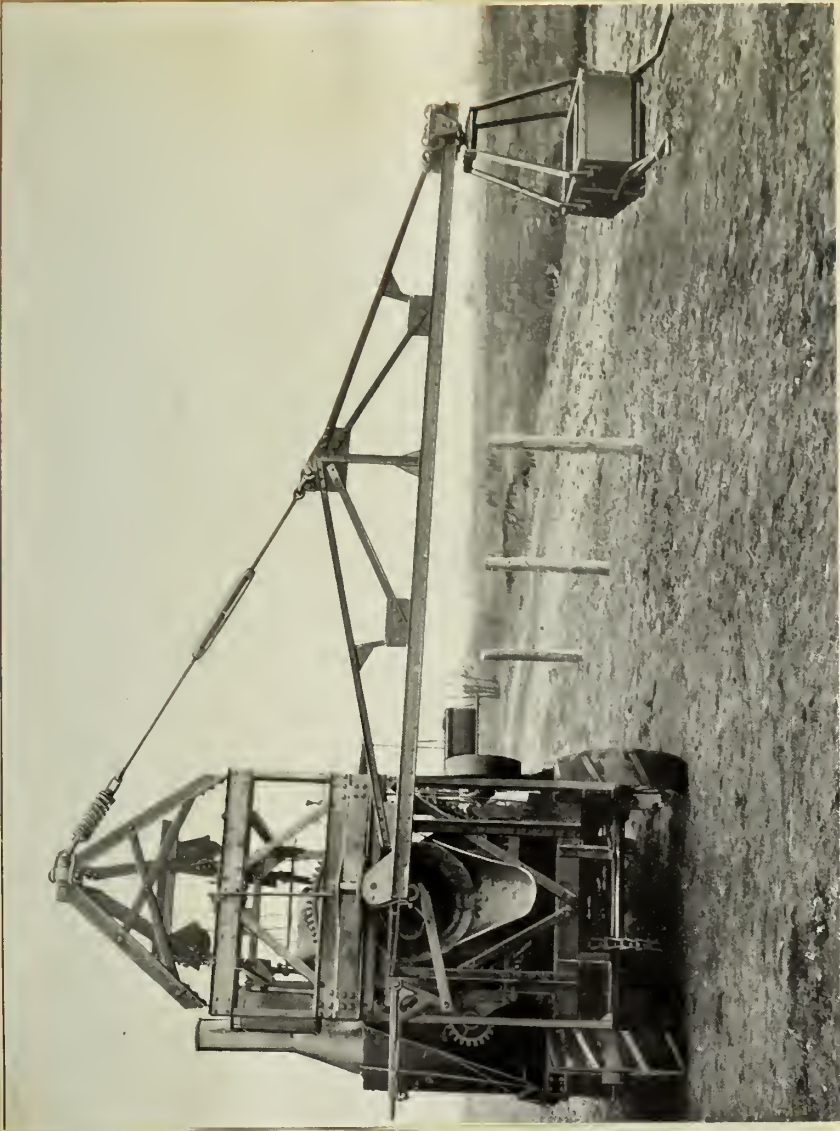

Fig. 103.

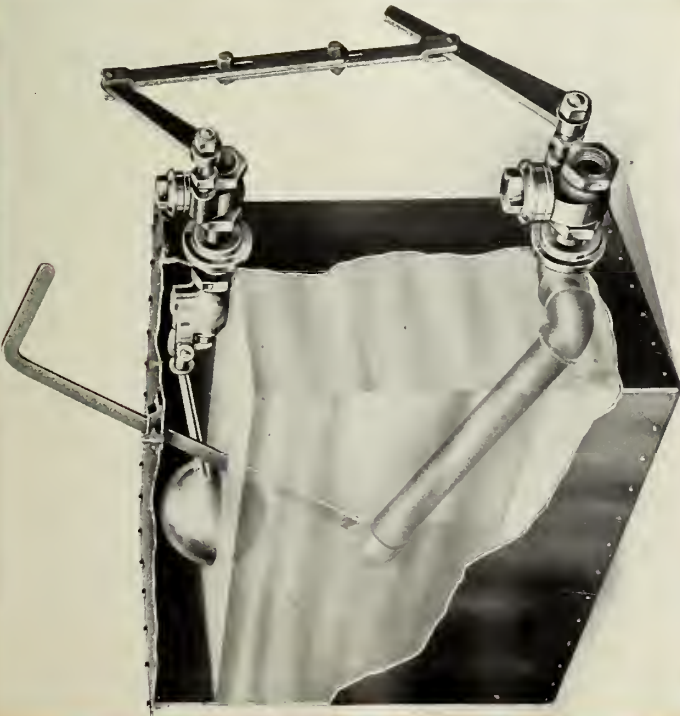

Fig. 104.

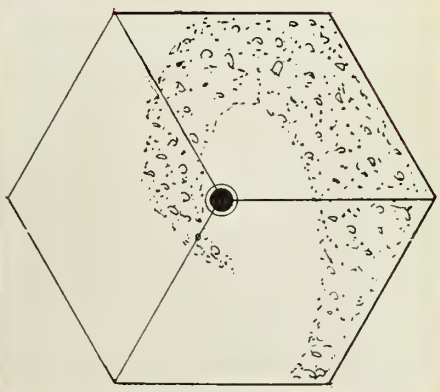

Fig. 101.

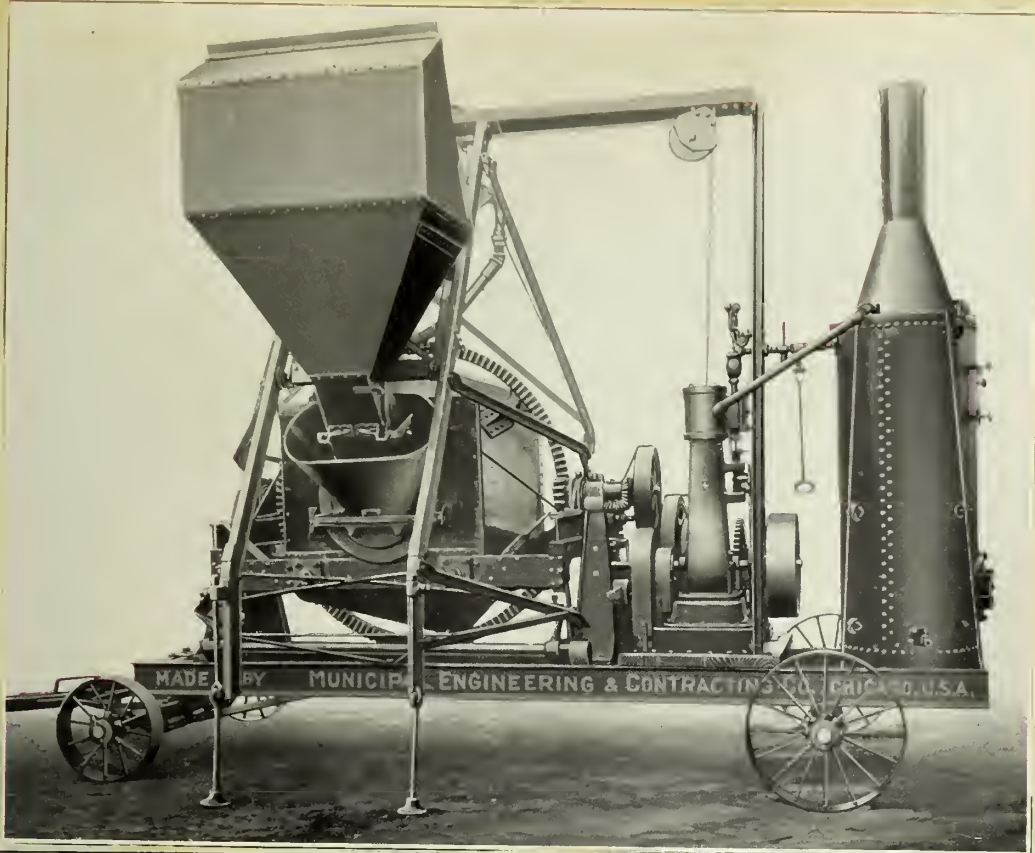

Fig. 102.



filled within twelve inches of the ground, and drawn to the top by a cable wound on a hoisting drum. The makers claim that the whole machine may be operated by one man. The mixer is tilted, and brought into the desired position for discharging by a lever within easy reach of the operator. Fig. 103 shows a view of the mixer with a boom attachment. The boom carries a bucket by which the concrete can be placed by moving the bucket in the desired direction. Fig. 104 shows a view of an automatic measuring water tank. The supply can be varied according to requirements by simply raising or lowering the gauge rod projecting over the top of the tank. In all machines the power is transmitted by gears, and either gasoline or electric power may be had.

Weight Without power	Output cubic yards per hour	Cost With power	Without power
1000	6	\$580.00	\$475.00
18000	120	\$4000.00	- - -

The Cockburn Mixer.

The Cockburn Mixer is manufactured by the Cockburn Company at Jersey City, N.J. The mixer is of the non-tilting drum type.

The drum is the shape of a cube and revolves on an axis through diagonally opposite corners. The action is such that the concrete is thrown from side to side six times for every revolution of the cube. The ingredients are subject to a further process of mixing since the bottom portions are being continually brought to the top and tumbled over.

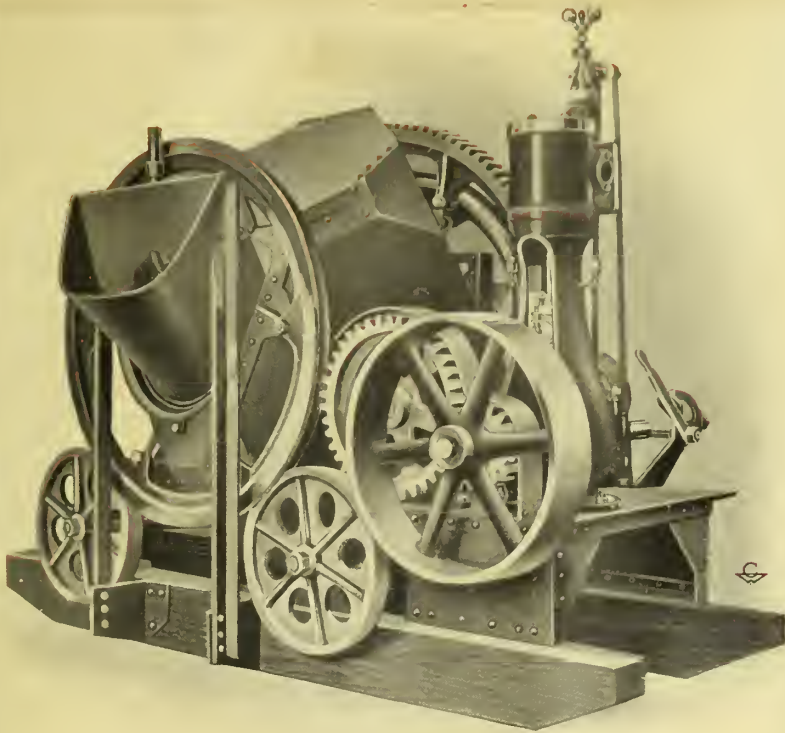

CHARGING SIDE

Fig. 105.

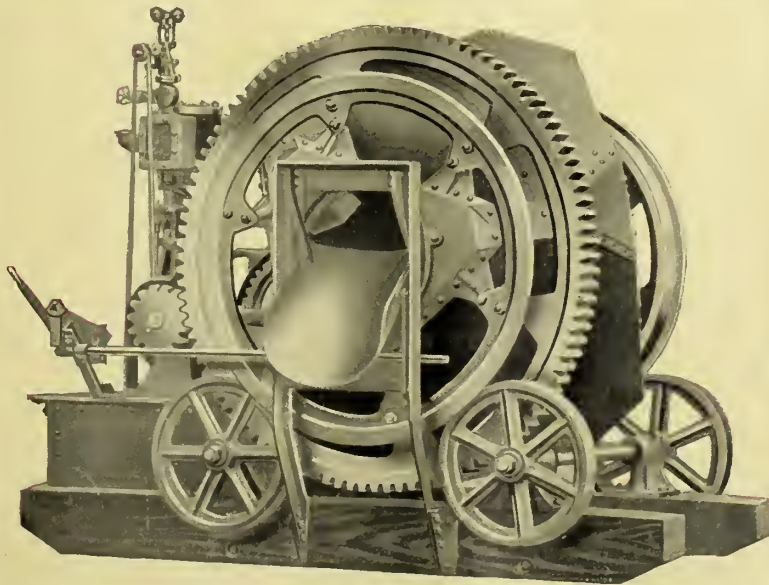

Discharging Side Showing Controlling Lever

Fig. 106.

Fig. 105 shows a general view of the mixer from the charging side. The ingredients are dumped into the hopper. Water for mixing purposes may be fed from a measuring tank or a hose through the charging chute. When the batch is being mixed, the discharge chute (See Fig. 106) is tilted to a retaining position, and the contents of each discharge scoop redeposited on the top of the material in the bottom of the cube in a continuous stream. The discharge scoops (not shown in the figure), which are fastened to the inside of the drum, have large surfaces and do not disintegrate the materials. The corners and angles of the cube are rounded, therefore there is no tendency for the materials to accumulate in the interior of the mixer.

When it is desired to have the concrete discharged very rapidly, the process is greatly facilitated by having a discharge hopper fastened to the discharge chute. This hopper has a capacity of two batches.

All the machines are gear driven and may be operated by steam, electric or gasoline power.

Output cubic yards per hour	Cost	
	With power	Without power
15	\$700.00	\$600.00
40	\$1450.00	\$1175.00

The North Western Mixer.

The Northwestern Mixer is manufactured by the Northwestern Steel and Iron Works at Eau Claire, Wisconsin. The mixer is of the non-tilting drum type. The essential characteristic of the mixer is the triangular shape of the drum, which

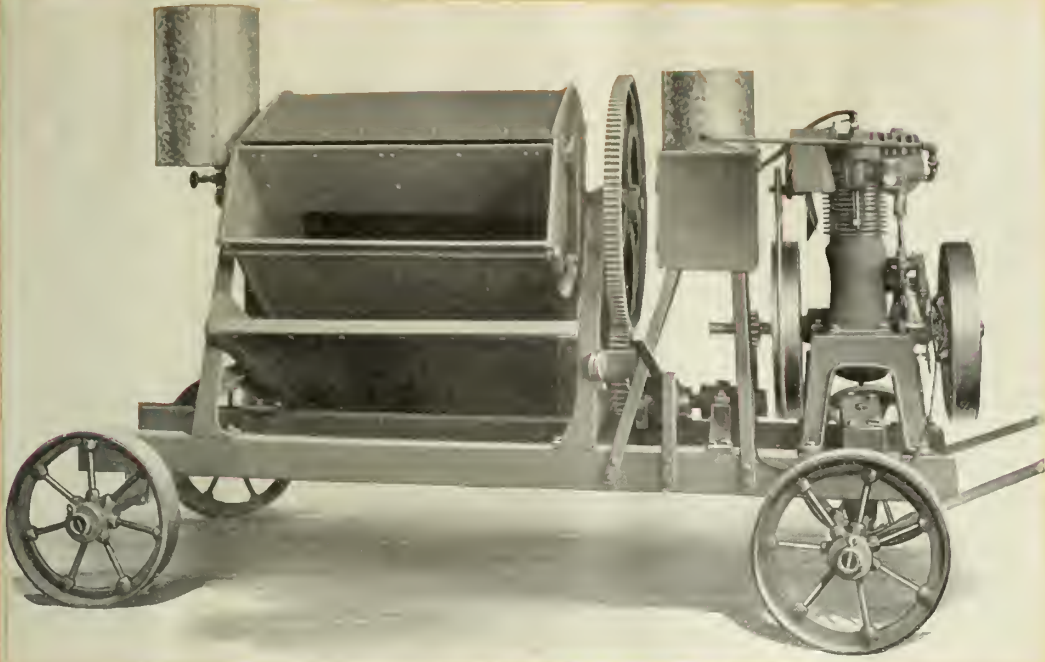

Fig. 107.



Fig. 108

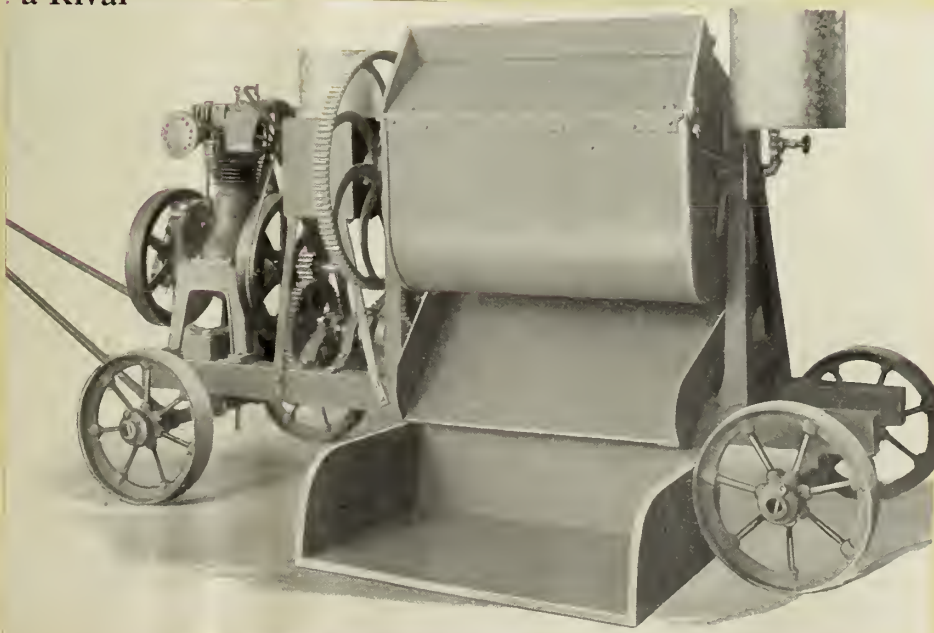

Fig. 109.

furnishes three mixes per revolution.

Fig. 107 shows a general view of the mixer. The contents are deposited in the drum through the opening shown in the figure. An automatic door, opening inward, remains closed when the drum is rotating. The movement of the door is controlled by a double action hand lever, and one push on this lever will either close or open the door. The contents of the mixer are moistened by a perforated pipe which runs through the center of the drum and is connected to a large galvanized water tank at the end of the mixer.

The machine is filled as shown in Fig. 108, or by the use of wheelbarrows on an elevated runway. A lever is then pushed forward, which closes the door, and the clutch is thrown over. After about three turns of the drum the water is turned on and the mixer run for about three-fourths of a minute. While the mixer is still running, a lever is pushed, and the door opens. When this opening is down, practically all the material will dump at one time; two or three extra revolutions will thoroughly empty the drum. The mixer is then stopped by throwing off the power, and the loading operation repeated.

Fig. 109 shows the mixer in a discharging position. The time of loading, mixing, and discharging is about two minutes. In all machines the power is transmitted by gears and is furnished by a gasoline engine.

Weight lbs. Without power	Capacity	With power	Cost Without power
600	1/4 cu.yd. per batch	\$324.00	\$189.00



Fig. 110.

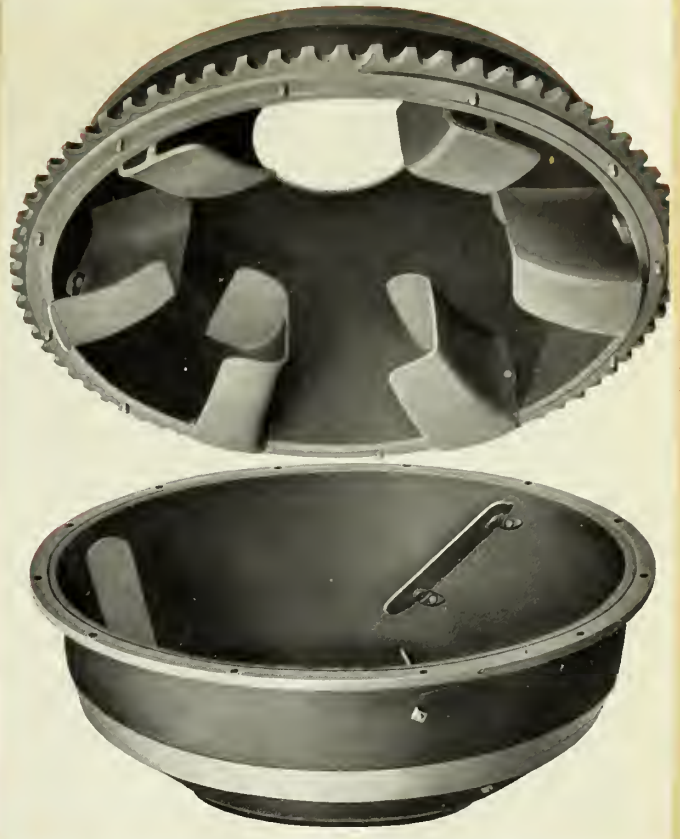

Fig. 112.

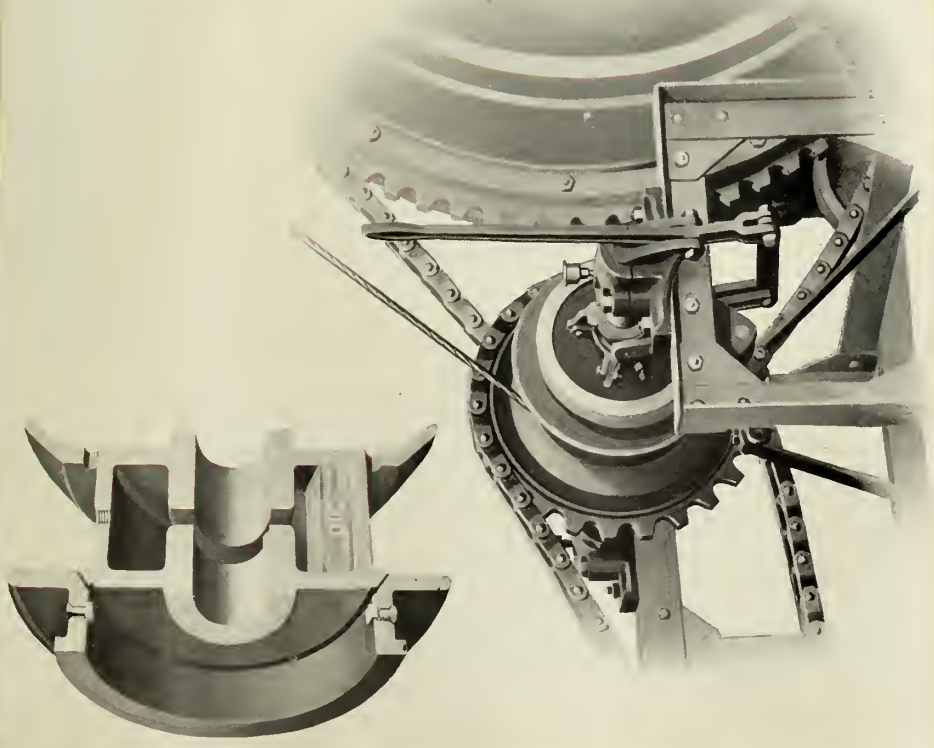

Fig. 111.

The Milwaukee Concrete Mixer

The Milwaukee Mixer is manufactured by the Milwaukee Concrete Mixer and Machinery Company at Milwaukee, Wis. The mixer is of the non-tilting drum type.

Figure 110 shows a view of the exterior of the drum. The receptacle has a spheroidal form, not a corner or angle in it. This produces a mixing chamber in which all material is naturally thrown toward the center, and there is no possibility of the concrete slopping out through the openings. It will be noticed that the drum is driven by a center belt chain drive.

Fig. 111 shows the method of transferring the power to the drum.

Fig. 112 shows an interior view of the drum. All the ingredients are folded over toward the center, and the discharging buckets, shown in the figure, are continually cutting through the material. The blades, shown in the figure at the left, plough through the material, stirring and grinding the aggregate, and picking up the concrete from the bottom of the drum. The action of the drum folds and refolds the batch over and over, holding it in one body, and does not separate the material. The charging is done either by an automatic hoisting bucket, or by a standard batch hopper.

Fig. 113 shows a view of the mixer with a batch hopper. When this is used, it is necessary to furnish some sort of a low charging platform. Figs. 114-115 show views of the mixer with an automatic hoisting bucket in different positions. A wire cable is attached to the hole passing through the sheave at the

Fig. 113.

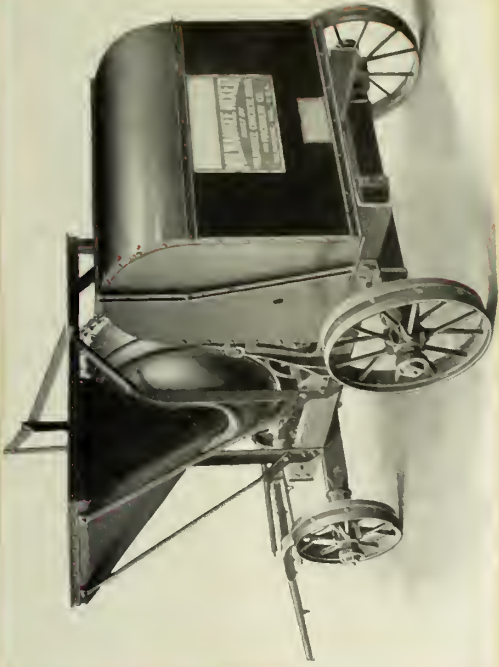

Fig. 115.

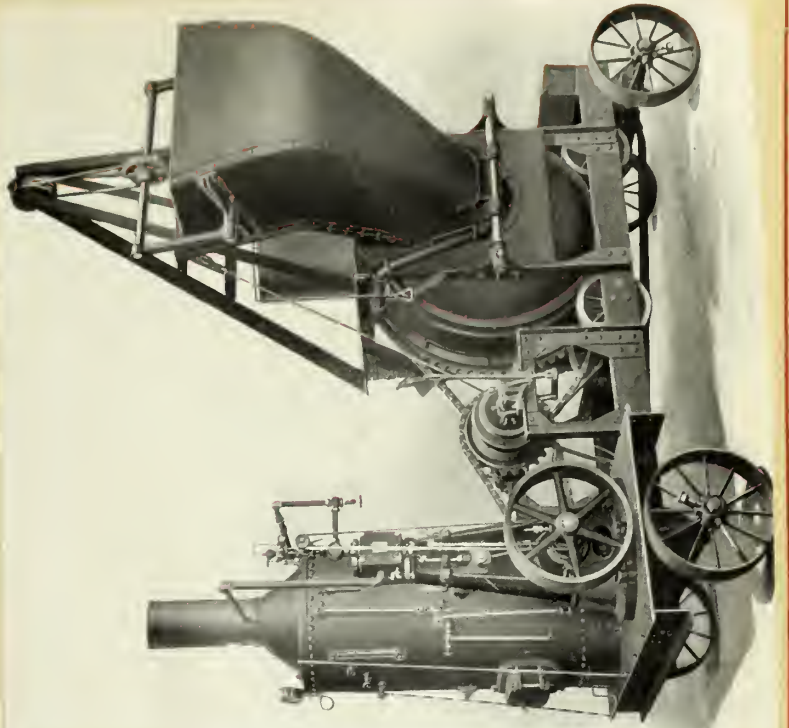

Fig. 114.

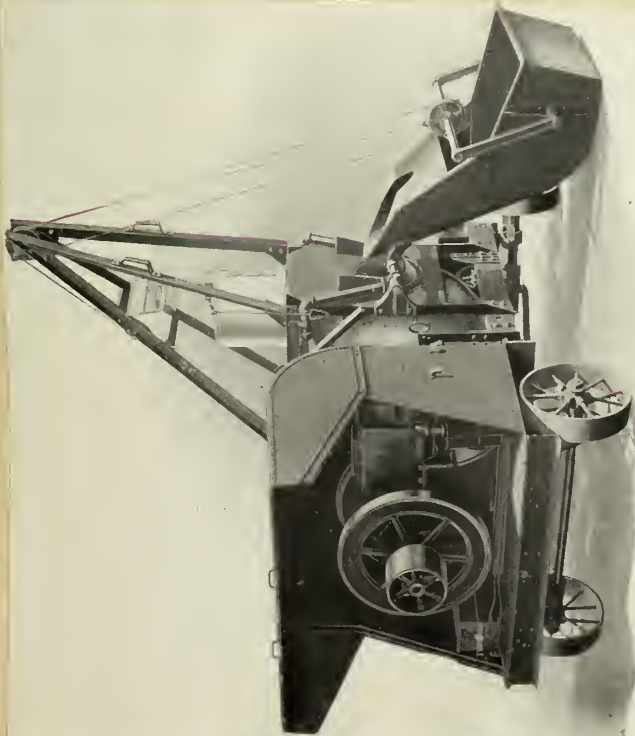
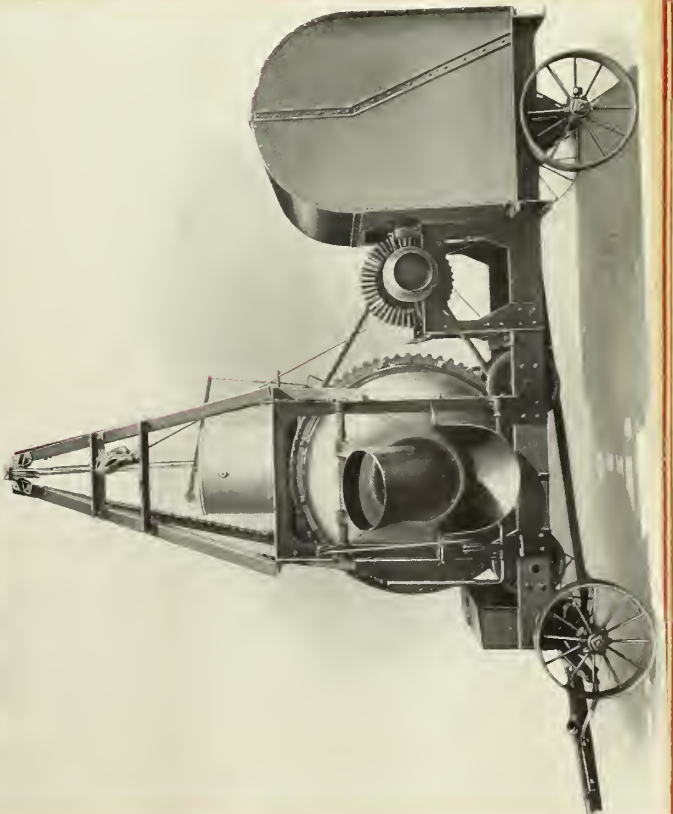

Fig. 116.



top of the boom, and then down to the winding drum on the main driving shaft. When the bucket is loaded, it is elevated to a discharging position by pushing a lever. By throwing the lever in the opposite direction, the bucket will return to the loading position. It requires but seven seconds for this operation. An automatic measuring tank governs the water supply. The adjustment of a simple set screw regulates the quantity. Fig. 116 shows a view of the mixer equipped with a discharging chute, which extends into the center of the drum. This is so arranged that no matter how high or low the material is lifted in the drum, the chute can be raised or lowered to catch the flow. To discharge the concrete, it is only necessary to pull a lever. A full batch can be discharged in from ten to fifteen seconds. The mixers may be equipped with gasoline or steam engine or electric motor.

Weight lbs. Without power	Output cubic yards per hour	With power	Cost Without power
2000	4	\$410.00	\$300.00
10000	60	\$1800.00	\$1575.00

The Smith Mixer.

The Smith Mixer is manufactured by the T.L. Smith Company at Milwaukee, Wisconsin. This mixer is of the tilting drum type.

Fig. 117 shows a sectional view of the drum. The drum consists of two steel cones, riveted to a central iron ring. Perfect alignment of the drum is assured at all times by six rollers running upon machined tracks on the central ring.



Figure 6—Sectional View of Smith Mixer Drum

Fig. 117.

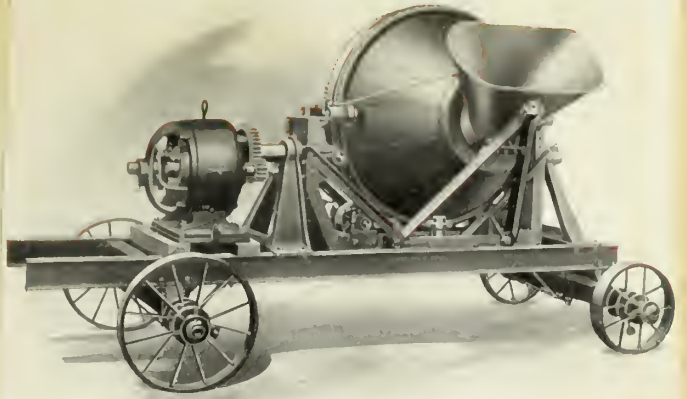

Fig. 118.

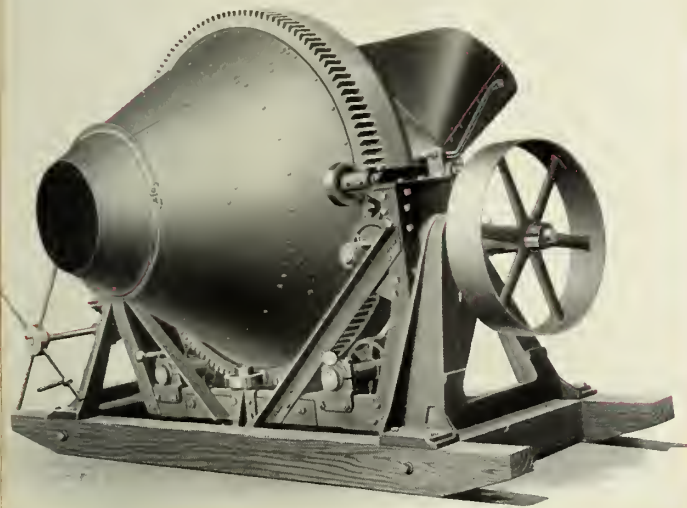

Fig. 119.

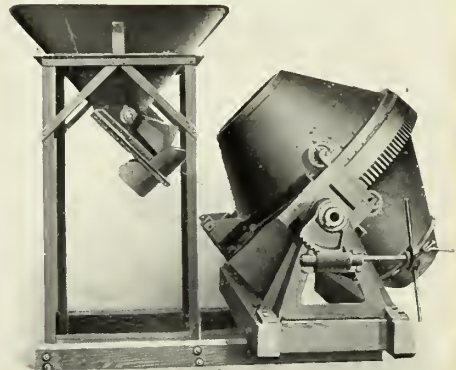

Fig. 120.



Figure 12—Smith Mixer with power-charging attachment, guide tracks extended

Fig. 122 a.

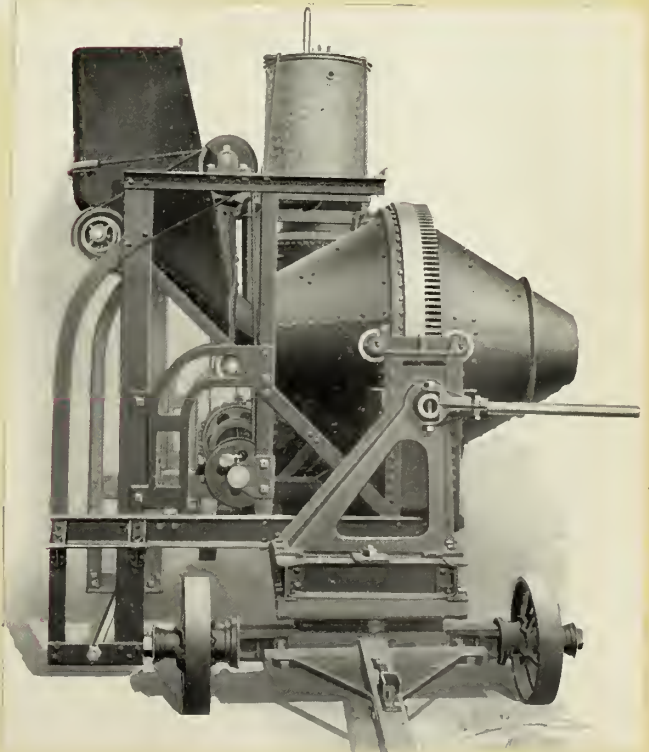

Fig. 122.

By looking at Fig. 117, it will be noticed that the blades are riveted in "V" shaped sets. When the drum is revolved, the materials are picked up and turned over by these blades, always gravitating backward to the center of the drum. The converging masses are forced through the restricted openings between the blades, mingling and recombining the particles in new relations toward each other, and pressing the ingredients into a uniform mass. The ingredients receive four mixes at every revolution of the drum. Fig. 118 shows a view of the feed end of the drum. This end is shortened up and flattened out to produce a vertical fall of the entering mass, and a rapid feed of the batch.

Fig. 119 shows the method of transmitting the power. This is accomplished by a miter gear on the main shaft and a bevel gear on the cross shaft. The spur of the last mentioned gear, meshing with the gear encircling the drum, causes the drum to revolve.

The mixer discharges by tilting while running. Fig. 120 shows a view of the discharging end. Fig. 120 shows a view of the mechanism governing the tilting of the drum. It consists of a screw (see Fig. 121) rotatable in either direction by two series of gears. These gears are controlled by two clutches operated from one lever. The tilting of the drum is effected by a nut which travels to and fro as the screw rotates. An arm (see Fig. 121) from the traveling nut connects with the tilting frame. When the tilting clutch is engaged, the screw revolves, causing the nut to travel away from the point of discharge, and thus tipping the drum. When the tilting clutch is thrown out, and the other clutch engaged, the rotation of the screw and the

travel of the nut are reversed, the drum being returned to mixing position.

The mixer may be charged with the use of a hopper or an automatic power loader. In the first case a charging platform is necessary, in the second case the charging platform is dispensed with. Fig. 122 shows a view of the side loader in a discharging position. The skip runs upon a curved track, and is brought into operation by pushing a lever. Fig. 122 (a) shows that the side loader may also be used as a material elevator with which to charge the mixer from a lower level. The guide tracks of the loading device may be extended downward ten feet, the lifting cable lengthened, and the skip dropped to the desired point to receive the batch.

Fig. 123 shows a view of the automatic water tank. The gauge is first set properly, and then a uniform quantity of water will be measured into each batch of concrete. Water must be supplied to the tank under city pressure or from a force pump. The tank is built in eighteen and thirty gallon sizes.

Fig. 124 shows a view of a mixer especially designed for street pavement work. The special features of this outfit are high wheels, allowing discharge direct into special spreader carts; an extended loader frame, permitting the operator to drop the skip so that the top thereof is on street level; a power tilt by means of which one man standing as shown in Fig. 124 can operate the loader, tank, and power tilt.

The mixer may be equipped with either electric motor, or steam, or gasoline engine.



Fig. 123.

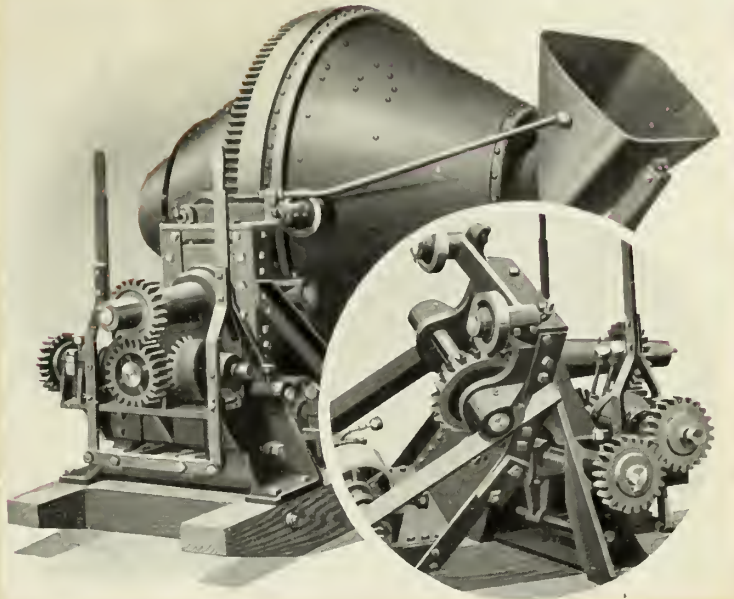

Fig. 121.



Fig. 124.

Weight lbs. Without power	Output cubic yards per hour	Cost	
		With power	Without power
2380	9	\$610.00	\$505.00
6750	104	\$2250.00	\$2200.00

The Hains Mixer.

The Hains Mixer is manufactured by the Hains Concrete Machinery Company at Washington, D.C. The mixer is of the gravity type. The process of mixing is based upon different principles than those used in the other mixers. The makers call the machine a batch rotary mixer, and state that in this method the mix is rotated instead of rotating the mixer.

Fig. 125 shows the mixer in both compacted and extended position. The materials are placed in horizontal layers in the top hopper, the water dashed evenly over the charge, and each hopper discharged into the one next below in a succession of steps. The entire charge, however, is received in one hopper before it is released into the one below. By noting Fig. 125 it will be seen that the machine consists of four conical hoppers suspended by chains one below another. The shapes and slopes of the sides are such that, when one hopper discharges into another, the ingredients do not slide, but fall inward at the center. The whole batch is given a rolling motion and the entire batch while rolling over itself, grinds together in passing the narrow outlet. It is claimed that the machine, when charged, will mix and discharge in forty seconds.

The method of operation is as follows. With the mixer in the telescoped position, put the broken stone or gravel in

an even layer in the top hopper. Spread the cement evenly over the stone. Spread the sand evenly over the cement. Dash the water for the mix over the top, wetting the whole surface. Now hoist the mixer and discharge from hopper to hopper, always receiving the entire charge in a hopper before again releasing it. To do this, hoist slowly and trip the latches to the hopper gates as they rise shoulder high; or hoist to the extended position and then trip the latches by using latch lines or a long hook.

The capacity of the mixer is two thirds of a cubic yard per batch. Figs. 126-127 show views of the machine in operation.

Cost of Mixer Complete

\$500.00

Loading Attachments.

The past few years have witnessed remarkable developments in the line of loading devices for batch mixers. These devices aim to increase the output of the mixer in a specified time and at the same time act as a labor saving device, thus diminishing the cost of operation.

The attachments may be classified under three heads: batch hoppers, power loading skips, and a combination of the two. These different attachments have been fully described and illustrated in their special connection with mixers, therefore only a brief summary of their use and operation will be taken up here.

Batch Hoppers.

The batch hopper is fastened upon the charging end of the machine, a gate or door, operated by a lever, closing the

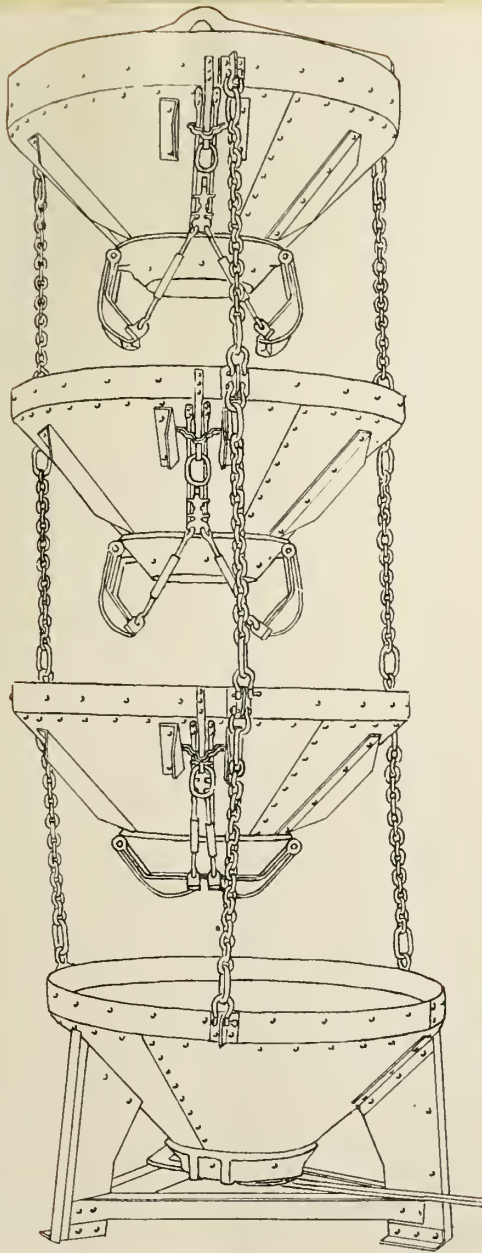

$\frac{2}{3}$

Cubic Yard Batch

WHEN CHARGED
WILL
MIX
AND
DISCHARGE
IN
FORTY SECONDS

Telescoped and Ready to Charge

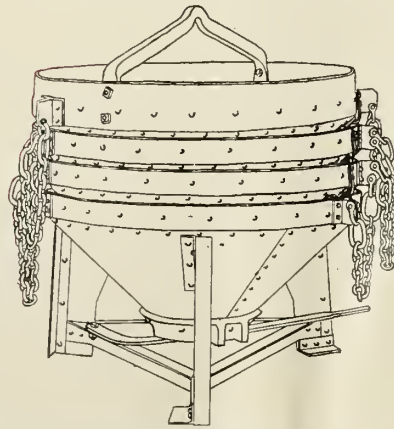

Height, Four Feet

Fig. 125.

TYPE B.

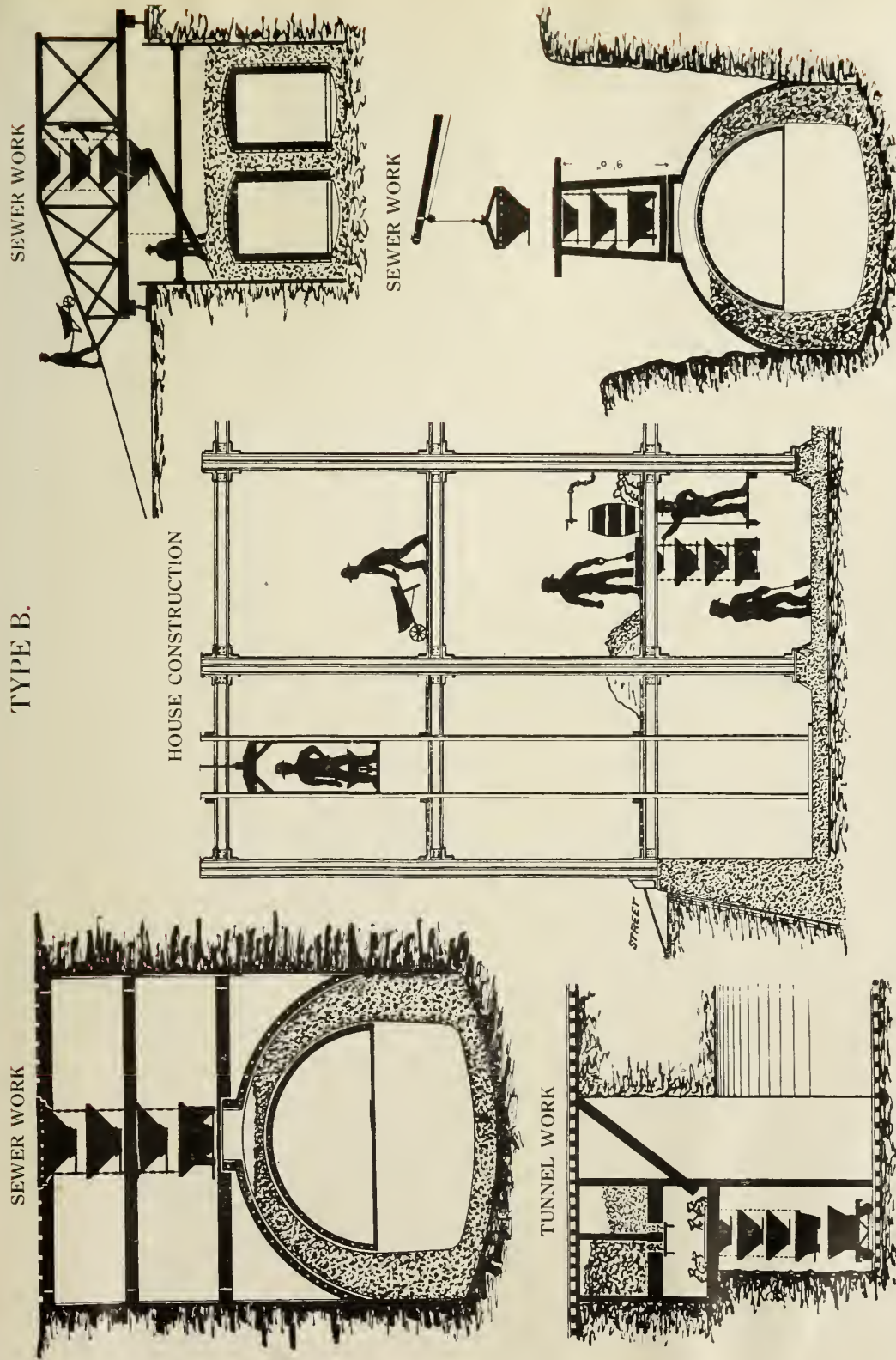

Fig. 126.



A NOVEL PLANT—CONCRETE MIXED ON THE END OF A STEAM SHOVEL

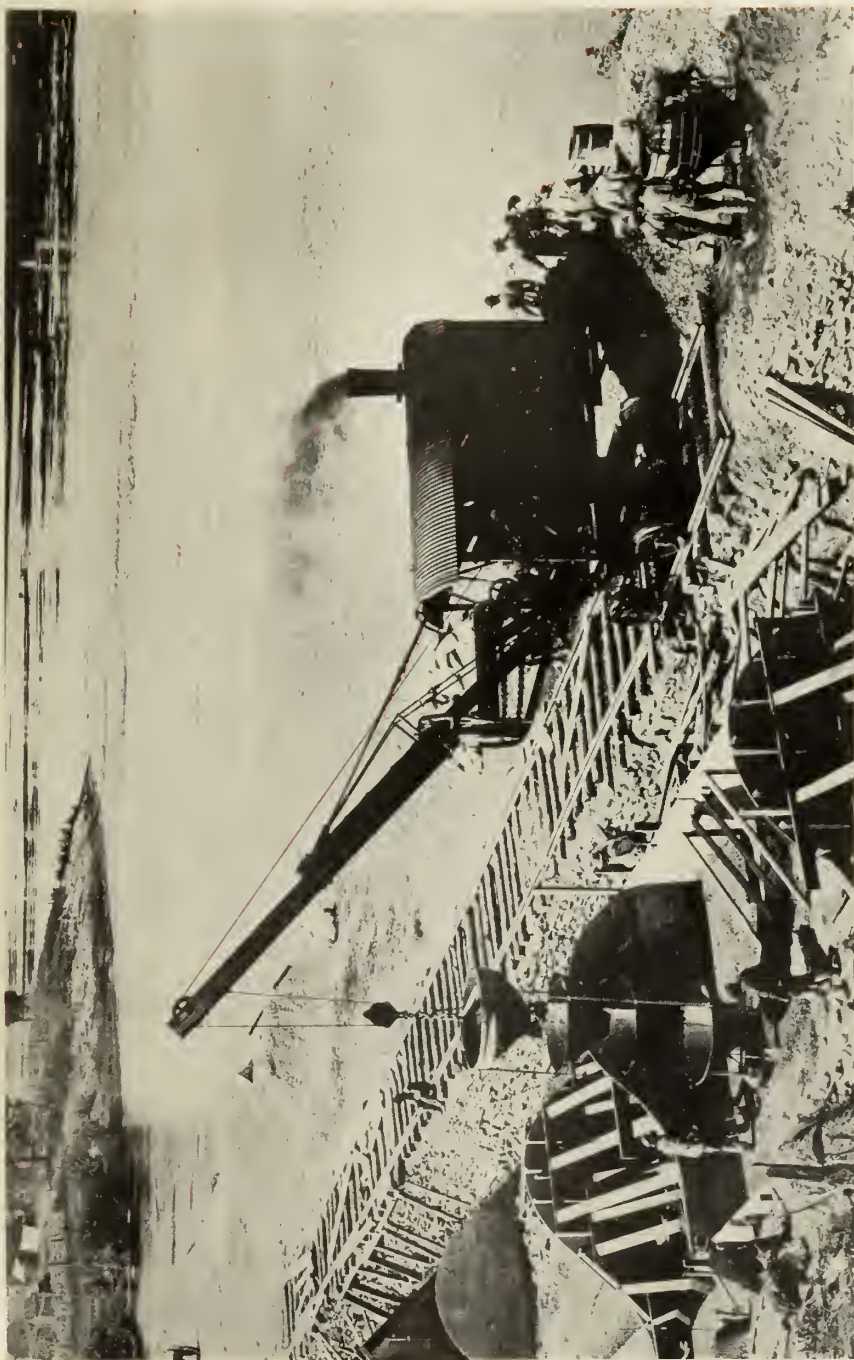

Fig 127.

opening into the drum. A measured batch of material is placed into the batch hopper while another batch is being mixed in the drum. As soon as the mixed batch is discharged from the drum, the gate is opened, and the material from the hopper runs into the drum ready for mixing.

The batch hopper is well adapted to construction where the materials can be loaded or supplied from a higher level, as from flat car or sidewalk to cellar.

Power Loading Skips.

The loading skip consists of a bucket that travels upon curved guides from the ground to the mixing drum. It is hoisted to the opening of the drum by means of wire cables which are in turn connected to the main shaft. The operation is simple. The skip is lowered to the ground and loaded with either shovels or wheel barrows while a batch is being mixed in the drum. As soon as a batch is discharged from the mixer, the skip is raised by the hoisting cable and the drum recharged.

Power loading skips are well adapted for use where the material to be mixed is on the same level with the bottom of the mixer, usually ground level.

Combination Batch Hopper and Power Loading Skip.

This device consists of a power loading skip which deposits its load into the batch hopper. Sometimes two skips are used, one on each side of the mixer. This method of operation makes delay impossible.

The combination is well adapted for use on very large mixers where a large gang of men can be used to keep the skip or skips loaded.

Special Discharging Attachments.

Numerous attachments have been devised to lessen the amount of hand labor in placing the concrete. The most important of these, however, have been described heretofore, and consist of either a skip travelling upon an arm or beam, or a long tube or discharge chute connected to the discharge side of the drum.

The first device is well adapted for depositing concrete into forms that are within a distance of not more than thirty feet from the mixer. The second device is generally used for paving or road work. It is especially advantageous where it is necessary to deposit concrete between the rails upon street pavement work, since the long discharge chute can be swung in a radius of 180° and thus allows the car traffic to pass while the work progresses.

COST DATA.

Mixer	No.	Size of Batch	Output cubic yards per hour	Cost of Mixer Without power
Batch				
Eclipse	140	1	30	\$860.00
Koehring	1 1/2	1/2	30	970.00
Cream City	4	1/3	60	960.00
Polygon	2	1/2	8	1275.00
Clover Leaf	15	1/2	13	760.00
Ransome	14	1/2	80	1250.00
Marsh Capron	2	1/2	35	950.00
Foote	6	1/2	40	1150.00
Chicago	14	1/2	32	790.00
Chain Belt	4	1/2	40	925.00
Chicago Cube	17	1/2	16	1250.00
Cockburn	40-27	1	40	1175.00
Northwestern	1	1/4	20	189.00
Milwaukee	1 1/2	1/2	60	1575.00
Smith	12	1/2	104	2200.00
Hains	--	2/3	--	500.00

Continuous

Kent	4		12.5	\$1100.00
Besser	1		8	350.00
S. & S.	-		15	450.00
Hartwick	3		15	450.00
Grand	3		15	475.00
Coltrin	14		20	425.00
Simplex	-		10	275.00
Bolte	A		6	160.00
Low Down	-		-	275.00
Eureka	81		15	650.00
Cockburn	-		25	--

The cost data table gives the name and number of the mixer, size of batch, the output in cubic yards per hour, and the cost of the mixer without power.

The output of the mixer is the manufacturer's rating. This output has not received a personal check by the observation of the writer, but reports from reliable sources show that the output has not been overestimated.

No attempt has been made by the writer to estimate or determine the number of men required to operate the different mixers. The number of men required is a very variable quantity and depends upon the size and character of the work and local conditions.

An attempt, however, has been made by the writer to determine the cost of repairs and maintenance of different mixers, and thereby determine the amount of depreciation. It was found that contractors could give no definite data as regards to depreciation so this important item has been neglected.

Conclusion.

It is not possible to choose one mixer and say it is the best of all mixers. Different conditions offer advantages and disadvantages to different types and forms. For example, a large expensive batch mixer could be advantageous where the work was such to warrant the expense of purchasing it. On the other hand a less expensive mixer, and one that is not heavy and cumbersome, would be advantageous on sidewalk or light foundation work. The character of the work, the locality, the number of men at the contractors disposal are factors that determine and enter into the conclusion as to what type of mixer to procure.

Therefore a comparison of the different types will be made, and a mixer of each general class will be chosen that possesses good qualities and whose first cost is an average one.

Batch Mixers.

Of the revolving drum type the writer believes that the Marsh Capron Mixer is the best batch mixer for the following reasons: (1) The mixer can be purchased with either a tilting or non-tilting drum. This is of no special advantage to the individual contractor since he will procure the type he wishes. Again the tilting mixer must be made very strong since eccentric stresses are developed during its discharge. However the fact that the mixer can be purchased in either form should not be overlooked since very few manufacturers, and not any to the writer's knowledge, make a mixer with two types of drum.

(2) The interior of the drum contains a greater number and a

more elaborate system of blades, buckets and deflectors than in any other mixer. This characteristic is a good one since there is greater opportunity for the materials to become more thoroughly mixed than in a drum which does not contain such a system of deflectors etc. On the other hand such an elaborate system of mixing apparatus is liable to incur expense and trouble by getting out of order causing the expense of repairs and renewal. (3) The output of material is as great as any other mixer of the same size. (4) The weight of the mixer is such that it may be moved around without causing much labor and expense. (5) The price of the mixer for its size and output is an average one.

(6) The mixer can be easily equipped with labor saving devices such as loading skips, batch hoppers, etc. This is a strong argument for this mixer since many other types are restricted to a single labor saving device or not any at all. (7) The teeth of the drive gear are fastened in segments. By this arrangement if a tooth breaks the segment may be removed and a new one fitted in a few minutes by the removal of only five bolts and without removing the drum or disturbing any part of the mixer.

(8) The drum is made entirely of a high grade of semi-steel. The metal possesses great strength and toughness, is exceptionally hard and offers the greatest resistance to the severe scouring action of the sand and stone.

The gravity mixer is by far the most economical batch mixer, since its first cost is low and its construction is so simple that there is little chance for the need of repairs. However its use is limited and it cannot be used under different conditions like the drum type. The gravity mixer is advantageous

for sewer work or foundations or any place where the concrete is to be deposited below the ground level. The Hains is the only important gravity mixer manufactured to-day.

Continuous Mixers.

The best type of continuous mixer is one having a feed caused by the reciprocating movement of the bottom of the hoppers and agitators that prevent the material from arching over the outlets.

In this form of feeding device there is a less complicated mechanism than in the others. The operator can easily see the hopper bottom moving back and forth, and, if it is in motion, the material is bound to be deposited in the mixing trough provided that the agitators are moving. The Hartwick mixer possesses these qualities and meets these requirements. Again, it is the only mixer that has a double mixing trough. This enables more material to be mixed at one time and receive the same amount of mixing than a single trough of the same volume. The machine can be fed from either or both sides which characteristic is a labor saving since it is not necessary to carry the charging material around the mixer to deposit it in the hopper. The output of the mixer is greater than other mixers of the same weight, and its cost is an average one.

Comparison of Batch and Continuous Mixers.

In the past, continuous mixers have been restricted to work where great strength of concrete was not required. The batch mixers have been generally used where accurate proportions

of the materials were desired. The objections to the continuous mixer were that the proportions, as measured by automatic measuring devices, were uncertain. The best continuous mixers of to-day, however, have overcome this objection, and there is no doubt but that they measure the proportions of materials with more certainty than will be measured by ordinary laborers with shovels or wheel-barrows.

The argument is made that the mix in the continuous mixer is not thorough, since in the mixing trough the ingredients keep about the same relative positions to each other during the progress from one end of the trough to the other. In the case of the batch mixer every part of the batch has an opportunity to come in contact with every other part. The product of the continuous mixer is uniform in consistency as well as mixture since smaller proportions of the materials are mixed at one time. In the batch mixer one batch is liable to be over mixed and another under mixed, and to get uniform consistency an automatic measuring tank is advisable.

The output of the batch mixer is about two and a half times as great as a continuous mixer, but since the first cost of the batch mixer is about double that of the continuous, there is no reason why two continuous mixers could not be used where a large output is required. As to the economy of mixing, the continuous mixer is the cheaper since no time is lost in measuring the materials. On the other hand the batch mixer with batch hopper and power loader is an economical time saver, but its first cost is greater.

It is the writer's opinion, therefore, that the best type of mixer is the continuous and that the best mixer of this type is the Hartwick.



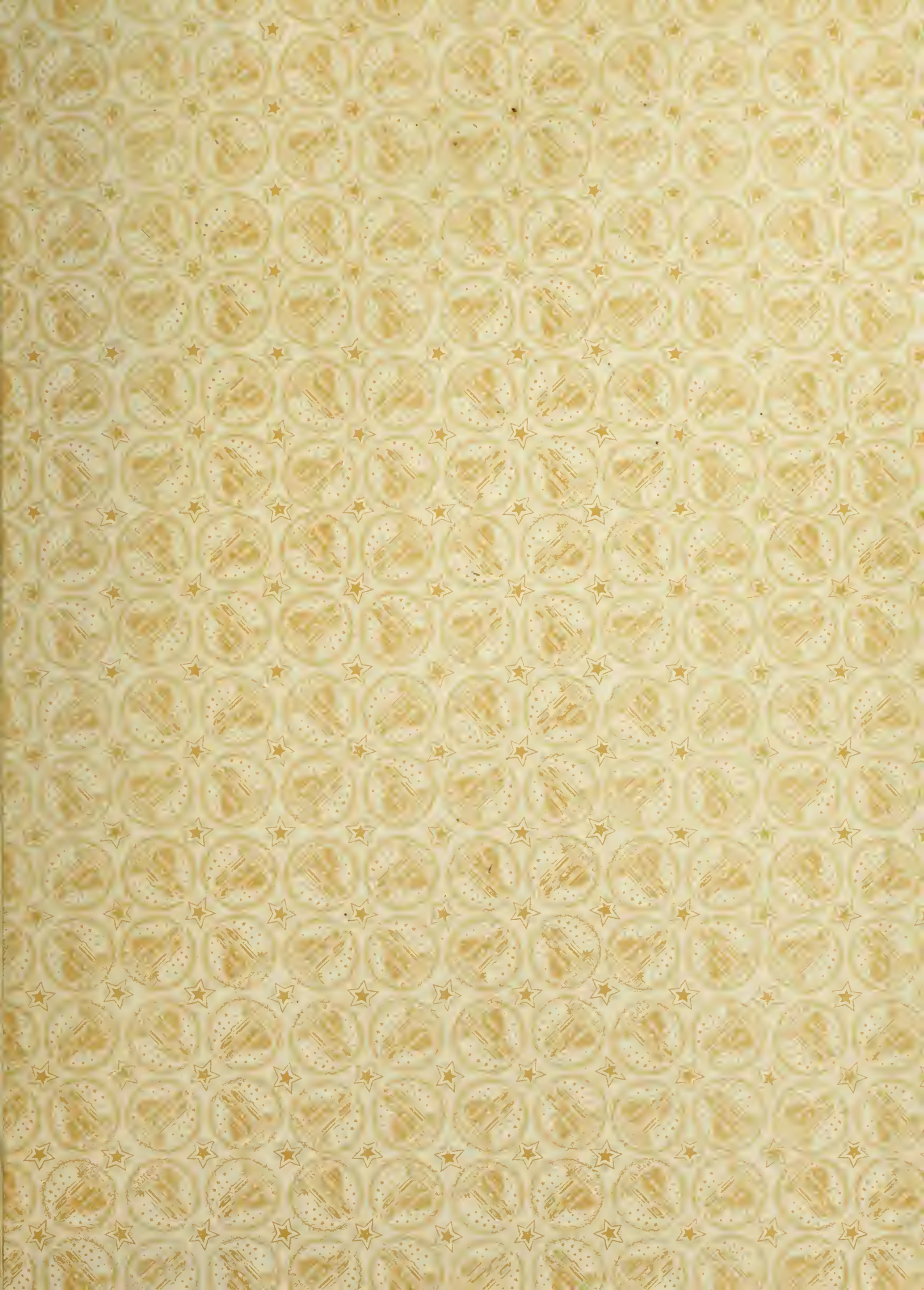

UNIVERSITY OF ILLINOIS-URBANA

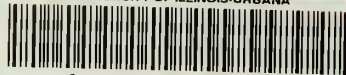

3 0112 086858476